

# RUSSO

CATALOGO  
2026

## TERMIDRAULICA

TERMIDRAULICA RUSSO



**RUSSO**  
TERMIDRAULICA



# L'azienda

**RUSSO TERMIDRAULICA** è una ditta a conduzione familiare specializzata nel **settore idrotermosanitario**.

La nostra è un'azienda giovane e dinamica, offriamo una **vasta scelta di prodotti e marche certificate** per darvi il **miglior rapporto qualità/prezzo**.

Il nostro personale si prende cura delle tue necessità con professionalità, esperienza e passione, garantendo **risposte tecniche e preventivi immediati**, impegnandosi a ricercare le **soluzioni più innovative e personalizzate** che rispondano in modo mirato a qualsiasi richiesta.

**Ti ascoltiamo sempre:** siamo pronti ad accogliere ogni consiglio per migliorare i nostri servizi insieme a te.

**Inoltre vi garantiamo:**

- **consegna rapida;**
- **assistenza pre/post vendita**
- **supporto per la progettazione di impianti di riscaldamento, condizionamento, piscine e irrigazione.**

## Per i vostri ORDINI e PREVENTIVI

**Telefono: 0933 940025**

Per richiedere informazioni, preventivi, ordini un addetto è a vostra disposizione dal lunedì al venerdì dalle 8:00 alle 13:00 e dalle 15:00 alle 19:00.



**Whatsapp: 349 5074465**

- Inviateci il modulo ordine/preventivo che trovate nel catalogo, compilato in ogni sua parte.
- Potete utilizzare il numero whatsapp anche per inviarci foto di ricambi, o richieste di supporto.



**E-mail: [commercialeasrusso@gmail.com](mailto:commercialeasrusso@gmail.com)**

Potete allegare via mail la scansione del modulo ordine/preventivo che trovate nel catalogo, compilato in ogni sua parte, oppure potete inviare una mail specificando il codice prodotto, le quantità, i vostri riferimenti e i dati utili per la risposta e/o consegna.



**E-mail: [amministrazioneasrusso@gmail.com](mailto:amministrazioneasrusso@gmail.com)**

Per informazioni contabili o amministrative, potete inviare richieste in qualsiasi momento, vi risponderemo in maniera rapida ed esaustiva.



**VISITA IL NOSTRO SITO:**

**[www.termoidraulicarusso.com](http://www.termoidraulicarusso.com)**

**Richiedi le credenziali per entrare nell'area riservata.**

**Potrai verificare i prezzi aggiornati e la disponibilità della merce.**

**Troverai offerte a te dedicate.**

Home

Azienda

Servizi

Prodotti

Contatti



Home

Azienda

Servizi

Prodotti

Contatti



CONSEGNA  
VELOCE



PAGAMENTI  
SICURI



RESO  
FACILE



RITIRO IN  
NEGOZIO



ASSISTENZA

**Russo Termoidraulica  
Grammichele CT**

Via Svizzera 5, 95042

tel: +390933840875

email:

[termoidraulicarusso@gmail.com](mailto:termoidraulicarusso@gmail.com)

Orari: lun-ven: 08:00 - 13:00, 15:00-

19:30 sabato: 08:00-13:00

**Menu**

[Chi siamo](#)

[Condizioni generali di  
vendita](#)





















[Spedizioni e modalità  
di pagamento](#)

[Informativa Privacy](#)

[Cookie Policy](#)

I prezzi in vigore nel presente catalogo possono cambiare in qualsiasi momento. Per i prezzi di listino in vigore, si prega di consultare il sito: [www.termoidraulicarusso.com](http://www.termoidraulicarusso.com) I prezzi di listino sono esclusi di IVA, RAEE, POLIECO, installazione e, dove obbligatorio, del primo avviamento da parte del centro assistenza. I dati tecnici comunicati dal fornitore, potrebbero subire delle variazioni. Si declina ogni responsabilità per eventuali errori di stampa.

## SISTEMI DI RISCIAQUO E SCARICO

	<b>A1 - CASSETTE WC CR 001 - 004</b>	
	<b>A2 - CASSETTE WC OLI 005</b>	
	<b>A3 - CASSETTE WC BAMBI 006</b>	
	<b>A4 - CASSETTE WC GEBERIT 007 - 008</b>	
	<b>A5/A6 - CASSETTE WC, PLACCHE E RICAMBI PUCCI 009 - 024</b>	
	<b>A7 - MEMBRANE PER CASSETTE WC 025 - 028</b>	
	<b>A8 - BATTERIA CATIS 029</b>	
	<b>A9 - RICAMBI TODINI 031 - 035</b>	
	<b>A10 - BATTERIE E RUBINETTI PER CASSETTE WC 036 - 038</b>	  
	<b>A11 - PASSO RAPIDO 039 - 040</b>	
	<b>A12 - VITONI RICAMBIO PER RUBINETTI 041 - 045</b>	

# INDICE

## ELEMENTI BAGNO

### B1/B2 - ELEMENTI BAGNO 101 - 106

**GRAVENA** *Laneri*  
sanitary ware



### B3 - ELEMENTI BAGNO DISABILI 107 - 109



### B4 - PILOZZE E ACCESSORI BAGNO 110 - 115

**FCR** **METAFORM**



### B5 - SEDILI WC 116 - 120

**FCR** **DMC** **METAFORM**  
ARREDO BAGNI



### B6 - CERNIERE WC 121 - 123



### B7 - FISSAGGI SANITARI 124 - 126

**fischer**  
I SISTEMI DI FISSAGGIO



### B8 - PIATTI E BOX DOCCIA 127 - 132

**DMC** **GIAVA**  
ARREDO BAGNI



### B9 - KIT E ASTE DOCCIA 133 - 136

**DAMAST**



### B10 - BRACCI DOCCIA E SOFFIONI 137 - 142



### B11 - DOCCETTE 143 - 147

**DAMAST**



















### B12 - FLESSIBILI DOCCIA 148 - 149

**DAMAST**



## MISCELATORI E ACCESSORI

	<b>C1 a C10 - MISCELATORI BAGNO 201 - 211</b>	
	<b>C11 a C17 - MISCELATORI CUCINA 212 - 222</b>	
	<b>C18 - MISCELATORI A PEDALE 223 - 224</b>	
	<b>C19 - CANNE DI RICAMBIO 225 - 227</b>	
	<b>C20 a C21 - LEVE E ACCESSORI DI RICAMBIO 228 - 229</b>	
	<b>C22 - CARTUCCE PER MISCELATORI 230 - 236</b>	
	<b>C23 - AERATORI 237 - 241</b>	
	<b>C24 - FLESSIBILI 242 - 246</b>	
	<b>C25 - RUBINETTI LAVATRICE 247 - 249</b>	
	<b>C26 - RUBINETTI FILTRO 250</b>	 
	<b>C27 - TUBO RAME CROMATO E ACCESSORI 251 - 252</b>	

# INDICE

## PILETTE E SIFONI

### D1 - PILETTE PER SANITARI 301 - 304

**CGS**



### D2 - PILETTE IN PVC 305 - 309

**FCR**

**bonomini**



### D3 - SIFONI IN MOPLEN 310 - 312

**bonomini**



### D4/D5 - SIFONI FLESSIBILI 313 - 315

**bonomini**

**VR** YDRO-REX

**TECOM**



### D6 - SIFONI ABS 316

**bonomini**

**TECOM**



### D7 - SIFONI OTTONE 317 - 320

**bonomini**

**TECOM**



### D8 - ROSETTE 320



### D9 - GUARNIZIONI 321 - 324



### D10 - MORSETTI E CURVE WC 325 - 331

**ITPLAST**



## PILETTE E SIFONI



D11 - ACCESSORI VASCA 332

**CGS**



D12/D13 - SIFONI VASCA E DOCCIA 333 - 336

**bonomini**  
SISTEMI PER IL DOLCE ACQUA

**CGS**



D14 - POZZETTI E CHIUSINI IN PP 337

**AIRGAMA**  
SISTEMI PER IL DOLCE ACQUA



D15 - LAVATRICE 338 - 339

# INDICE

## RUBINETTI - VALVOLE E REGOLATORI GAS

### E1 - RUBINETTI GIARDINO 401 - 405



### E2 - VALVOLE A SFERA MINI 406



### E3 - VALVOLE A SFERA 407 - 408



### E4 - VALVOLE ACCIAIO 409



### E5 - VALVOLE A SFERA C/RACCORDO 410 - 411



### E6 - VALVOLE INCASSO 412



### E7 - VALVOLE MOTORIZZATE 413



### E8 - ELETTROVALVOLE 414



### E9 - VALVOLE A SFERA E RUBINETTI GAS 415 - 417



### E10 - TUBO GOMMA GAS E ACCESSORI 418 - 421



## RUBINETTI - VALVOLE E REGOLATORI GAS



**E11 - REGOLATORI GAS 422 - 425**



**E12/E13 - FLESSIBILI GAS E ACCIAIO 426 - 428**



**E14 - GALLEGGIANTI 429 - 432**



**E15 - CONTATORI 433**



# INDICE

## TUBI E RACCORDI OTTONE - MULTISTRATO - ZINCATO - PPR E POLIETILENE

**F1 - VALVOLE RITEGNO 501 - 502**

**APM**



**F2 - RACCORDI IN OTTONE 503 - 504**

**RINALDI & PETTINAROLI**



**F3/F4 - RACCORDI IN OTTONE GIALLO E CROMATO 505 - 512**

**CC**



**F5/F6 - RACCORDI IN GHISA E TUBI ZINCATI 513 - 519**



**F7 - RACCORDI DI RIPARAZIONE NICHELATI 520**

**RINALDI & PETTINAROLI**



**F8/F9 - TUBO MULTISTRATO 521 - 522**

**ISOCLIMA**

**GIACOMINI**  
SARRE & BERTINI



**F10/F11 - RACCORDI MULTISTRATO A STRINGERE 523 - 527**

**NIM**

**GIACOMINI**  
SARRE & BERTINI



**F12 a F15 - RACCORDI MULTISTRATO A PRESSARE ACQUA E GAS 528 - 540**

**ICMA**

**GIACOMINI**  
SARRE & BERTINI



**F16 - TUBI E RACCORDI IN PPR 541 - 549**

**ATP**



## TUBI E RACCORDI OTTONE - MULTISTRATO - ZINCATO - PPR E POLIETILENE



**F17 - TUBO POLIETILENE 550 - 551**

**irritec**



**F18 - RACCORDERIA PER PE ANIMA IN TEFLON 552 - 553**



**F19 - RACCORDERIA PER PE ANIMA IN OTTONE 554 - 556**



**F20 - RACCORDI POLIETILENE AD 557 - 559**



**F21 - RACCORDI POLIETILENE FILETTATI 560 - 562**



**F22 - IRRIGAZIONE 563 - 564**



**F23 - RACCORDI PORTAGOMMA 565 - 566**



**F24 - VALVOLE IN POLIETILENE 567**

**irritec**



**F25 - SERBATOI POLIETILENE 568 - 571**



# INDICE

## TUBI DI SCARICO - SIGILLANTI E ATTREZZATURE IDRAULICHE

G1/G2 - TUBI E RACCORDI IN PPS 601 - 614



G3 - COLLARI CON TASSELLO 615 - 617



G4 - TASSELLI 618 - 619



G5 - ADESIVI E SIGILLANTI 620 - 625



G6 - CANAPA - TEFLON 626 - 627



G7 - PRODOTTI CHIMICI 628 - 631



G8 - DISOTTURATORI ED ATTREZZATURE 632 - 633



G9 - ATTREZZATURA IDRAULICA 634 - 638



G10 - PRESSATRICI MULTISTRATO 639



G11 - ATTREZZATURA IDRAULICA PER RAME 640



G12 - ATTREZZATURA PER CLIMATIZZATORI 641



## RAME E CLIMATIZZAZIONE



H1 - TUBI RAME 701

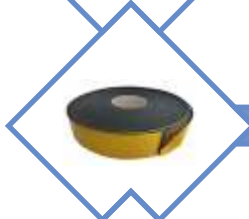

H2 - ISOLANTE 702



H3 - RACCORDI A STRINGERE PER RAME 703 - 705



H4 - RACCORDI PER CONDIZIONAMENTO 706 - 708



H5 - GAS CONDIZIONAMENTO 709



H6 - TUBO RAME SPLIT 710



H7/H8 - CASSETTE, SIFONI E CLIMA 711 - 712



H9 - CANALINA PER CLIMA 713 - 714

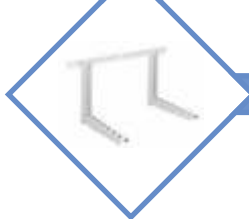

H10 - STAFFE PER CLIMATIZZATORI 715



# INDICE

## RAME E CLIMATIZZAZIONE

### H11 - ASPIRATORI 716



### H12 - TRATTAMENTO ARIA 717



### H13 - CLIMATIZZATORI 718 - 719



## PRESSURIZZAZIONE E TRATTAMENTO ACQUA



11/13 - ELETTROPOMPE PEDROLLO 801 - 807



14 - ELETTROPOMPE LOWARA 808 - 809



15 a 17 - ELETTROPOMPE X-POWER 810 - 815



18 - ACCESSORI PER ELETTROPOMPE 816



19 - ELETTROPOMPE PISCINA E GIARDINO 817



110/111 - PRESSCONTROL 818 - 820



112 - ALIMENTATORI ARIA 821



113 - PRESSOSTATI E MANOMETRI 822 - 823



114 - IDROSFERE 824 - 825



# INDICE

## PRESSURIZZAZIONE E TRATTAMENTO ACQUA

**115 - GALLEGGIANTI ELETTRICI 826**



**116 - FILTRI E CARTUCCE 827 - 831**

**XPOWER**  
WATER - PUMPS



**117 - FILTRAZIONE E ADDOLCITORI 832 - 836**



**118 - TUBI E RACCORDI ALTA PRESSIONE 837 - 838**



**119 - RIDUTTORI DI PRESSIONE 839**

**/// FARE**



## RISCALDAMENTO: CALDAIE - RADIATORI E ACCESSORI



**K1 - VALVOLE E DETENTORI IVR 901 - 902**



**K2 - VALVOLE E DETENTORI APM 903 - 904**



**K3 - VALVOLE E DETENTORI ICMA 905 - 907**



**K4 - VALVOLE E DETENTORI GIACOMINI 908 - 911**



**K5/K6 - ACCESSORI PER RADIATORI 912 - 916**



**K7/K8 - COLLETTORI E ADATTATORI 917 - 918**



**K9 - COLLETTORI E CASSETTE FAR 919 - 920**



**K10 - RADIATORI ALLUMINIO 921**



**K11 - SCALDASALVIETTE 922 - 923**



**K12/K13 - VENTILCONVETTORI 924 - 929**



# INDICE

## RISCALDAMENTO: CALDAIE - RADIATORI E ACCESSORI

### K14 - TERMOSTATI 930 - 931

**cewal**  **seitron**



### K15/K16 - CALDAIE 932 - 934

 **ITALTHERM**  **Chaffoteaux**



### K17 - DEFANGATORI 935 - 936



## ACS: SCALDABAGNI E SOLARE TERMICO



**L1 - SCALDABAGNI ELETTRICI 1001 - 1002**

**atlantic**  Chaffoteaux



**L2 a L4 - RESISTENZE E TERMOSTATI SCALDABAGNI 1003 - 1007**



**L5/L6 - SCALDABAGNI A GAS INNOVITA E ACCESSORI 1010**

**innovita**



**L7 - CIRCOLATORI 1011 - 1012**

**XPOWER**  
WATER - PUMPS



**L8 - TERMOSTATI 1013**



**L9 - VALVOLE SICUREZZA 1014**

**TECNOGAS**



**L10 - VALVOLE MISCELATRICI 1015**



**L11 - SOLARE TERMICO 1016 - 1018**



**L12 - BOLLITORI E POMPE DI CALORE 1019 - 1020**

**atlantic** **IOEMA**



**L13 - TUBO SOLARE E RACCORDI 1021**



**L14 - RACCORDI RAME PER SOLARE 1022**

# INDICE

## FUMISTERIA

**M1 - CANNA FUMARIA ACCIAIO INOX NERO 1101 - 1102**



**M2 - CANNA FUMARIA IN ACCIAIO AL CARBONIO 1103 - 1104**



**M3 - FUMISTERIA COASSIALE PER CALDAIE A CONDENSAZIONE 1105**



**M4 - TUBI E RACCORDI IN PPS PER CALDAIE A CONDENSAZIONE 1106 - 1109**



**M5 - TUBO FLESSIBILE ALLUMINIO 1110**



**M6 - TUBI E RACCORDI IN ACCIAIO MONOPARETE 1111 - 1114**



**M7 - ACCESSORI PER TUBI ACCIAIO 1115**



**M8 - TUBI E RACCORDI ACCIAIO DOPPIA PARETE 1116 - 1119**



# INDICE ANALITICO

## A

- Accessori bagno --> 112
- Accessori per canalina condizionamento --> 713
- Adattatori per collettori --> 918
- Adattatori per tubo rame e multistrato --> Ivr 904 - Apm 904 - Icma 906 - Giacomini 912
- Additivo per massetti --> 630
- Addolcitori --> 835
- Aeratori per miscelatori --> 237
- Aeratori prolungati --> 240
- Ala gocciolante --> 550
- Alimentatore d'aria --> 821
- Ancorante chimico --> 621
- Anticalcare per doccia --> 128
- Aquakit --> 622
- Archetto --> 632
- Aspiratore da muro --> 716
- Asta doccia --> 135
- Attacco 5 vie --> 822
- Attacco lavatrice --> 312

## B

- Bandella metallica --> 620
- Barriera d'aria --> 717
- Base a terra per condizionatori --> 715
- Batteria per cassetta WC --> Todini 35 - Pucci 20 - Oli 31 - Catis 29
- Benda bianca --> 710
- Blister per radiatori --> 914
- Box doccia --> Soffietto 129 - Acrilico 130 - Cristallo 131
- Braccio doccia --> Nero 138 - Cromato 140

## C

- Caldaia --> Chaffoteaux 932 - Italtherm 933
- Calibratore per tubi --> 638
- Camon --> 622
- Campana --> Todini 32 - Tremolada 28
- Canalina condizionamento --> 713
- Canalina doccia --> 132
- Canapa --> 627
- Canne di ricambio --> 225
- Cannuccia cromata --> 251
- Canotto cassetta incasso --> 9
- Canotto ottone --> 319
- Cartucce per filtro --> 829
- Cartucce per miscelatori --> 230

# INDICE ANALITICO

- Cassetta lamiera per contatore --> 433
- Cassetta per collettore --> 916
- Cassetta predisposizione condizionamento --> 711
- Cassette wc
  - ESTERNE --> CR 1 - Oli 5 - Bampi 6
  - INCASSO --> Oli 5 - Geberit 7 - Pucci 14
- Centralina gas --> 424
- Centralina per kit solare termico forzato--> 1016
- Centralina per termocamino --> 935
- Cerniere per sedile WC --> 121
- Cesoia per tubi --> 637
- Chiave per bombola --> 418
- Chiave per pilette --> 636
- Chiave per radiatori --> 914
- Chiavetta WI-FI per climatizzatori --> 719
- Chiusino sifonato in PP --> 336
- Circolatore --> 1011
- Climatizzatori --> 718
- Codolo moplen --> 333
- Codolo ottone --> 503
- Collare con tassello
  - IN ACCIAIO PER CANNE FUMARIE --> 1115
  - IN NYLON --> 618
  - VERNICIATI PER CANNE FUMARIE --> 1109
  - ZINCATI --> 617
- Collare di riparazione --> 520
- Collettori in ottone --> 916
- Collettori Far --> 919
- Colonna doccia --> 332
- Condensatori --> 805
- Contatore acqua --> 433
- Copricaldaia --> 931
- Cronotermostato --> Cewal 903 - Seitron 931
- Curvatubi --> 637
- Curvetta doccia --> 137
- Curvetta sottolavabo --> 251
- Cutter --> 632

## D

- Defangatore --> 935
- Deviatore per colonna doccia --> 136
- Deviatore universale per rubinetto --> 240
- Disgorgante --> 628
- Docchetta --> 144
- Dosatore sali polifosfati --> 936

## E

### Elettropompe

DI SUPERFICE --> Pedrollo **801** - Lowara **808** - X-Power **810**

GIARDINO --> **817**

PISCINA --> **817**

SOMMERSE --> Pedrollo **803** - Lowara **808** - X-Power **814**

Elettrovalvola --> **414**

Elettrovalvola giardino --> **563**

Esalatore --> **1010**

## F

Falso centro --> **222**

Fascette cablaggio --> **619**

Fascette fissaggio --> **616**

Filtro ottone ad Y --> **502**

### Flessibili

ANTIVIBRANTI --> **242**

IN ACCIAIO --> **428**

IN ACCIAIO PER GAS --> **427**

PER DOCCIA --> **149**

PER DOCCETTA --> **223**

Fossa IMOFH --> **571**

Frusta per condizionamento --> **709**

### Fumisteria

COASSIALE --> **1105**

IN ACCIAIO DOPPIAPARETE --> **1116**

IN ACCIAIO MONOPARETE --> **1111**

IN ACCIAIO NERA --> **1101**

IN PPS PER CALDAIE A CONDENSAZIONE --> **1106**

Fungo per cassetta ramo --> **27**

## G

### Galleggianti

ELETTRICI --> **825**

IN OTTONE --> **429**

Gas refrigerante --> **709**

Ghiera troppo pieno --> **241**

Giratubi --> **635**

Glicole --> **1017**

Griglie di aerazione --> **620**

Gruppo di circolazione per solare --> **1016**

Gruppo di riempimento --> **1012**

### Guarnizioni

ALLUMINIO --> **322**

ESENTE AMIANTO --> **321**

GOMMA --> **321**

IN CARTONCINO PER RADIATORI --> **915**

PER RESISTENZA SCALDABAGNO --> **1007**

# INDICE ANALITICO

## I

Idrosfera --> 825

Igienizzante per clima --> 631

Imbuto per jolly flex --> 313

## K

Kit antivibranti --> 715

Kit bocchettoni per circolatore --> 1011

Kit doccia --> 134

Kit durezza monocomponente --> 836

Kit fissaggio per miscelatori --> 241

Kit fimi coassiale universale --> 1105

Kit gruppo manometrico --> 641

Kit riparazione

FLUSSOMETRO --> 40

VITONI --> 41

Kit riqualificazione --> lvr 902 - Apm 903 - Icma 906 - Giacomini 910

Kit saldatura --> 640

Kit salvacaldaia --> 936

Kit solare termico naturale --> 1018

Kit ugelli per cucina --> 421

## L

Lampade UV --> 832

Leve di ricambio per miscelatori --> 228

## M

Manichetta --> 550

Maniglione

ACCIAIO --> 109

PLASTICA --> 109

RIBALTABILE --> 108

Manometro --> 823

Mascontrol --> 819

Matrice per polifusore --> 549

Membrana per cassette WC --> Pucci 25 - Varie 26 - Todini 32

Membrana per idrosfera --> 824

Mensole per radiatori --> 913

Miscelatore

A PEDALE --> 224

BAGNO --> Prince 201 - Sunny 202 - Niko 203 - Kubo 205 - 70sette 206 - Skate 207 - Jolly 208

Perseo 209 - Terra 210 - Terra nero 211

CUCINA --> 212

DOCGETTA ESTRAIBILE --> 223

Molla curvatubi --> 637

Morsetto

GOMMA --> 325

WC --> 328

## N

Nastro alluminio --> 710

## O

Osmosi inversa --> 832

## P

Pannello per solare termico --> 1017

Passaggio a cassone

OTTONE --> 503

PVC --> 561

Passo rapido e accessori --> 39

Pasta verde antigraffiante --> 626

Piatto doccia --> 127

Pilette doccia

A PAVIMENTO --> 334

Pilette

IN OTTONE --> 301

IN PLASTICA --> 305

Pilozza con mobile legno --> 110

Pilozza PVC --> 110

Pinza regolabile --> 635

Pinzatrice --> 639

Pistola per silicone --> 632

Placca --> Oli 5 - Geberit 7 - Pucci 15

Polifusore --> 549

Pomello ricambio --> 228

Pompa disostruente --> 633

Pompa per condensa --> 718

Pompa per vuoto --> 641

Pop-up --> 563

Portafiltro --> 827

Portagomma GPL e Metano --> 419

Pozzetto in PP grigio --> 337

Presa acqua --> 137

Presscontrol --> 818

Pressostato --> 822

Prodotti Facot

PER CLIMATIZZAZIONE --> 631

PER PULIZIA IMPIANTI TERMICI --> 628

Programmatori per giardino --> 564

Pulsante Todini --> 33

Pulsante pneumatico CR --> 3

Puffer --> 1018

## Q

Quadro per elettropompe --> 816

# INDICE ANALITICO

## R

### Raccordi

- ALTA PRESSIONE --> **837**
- A PRESSARE GAS PER MULTISTRATO --> Icma **533** - Giacomini **538**
- A PRESSARE PER MULTISTRATO --> Icma **527** - Giacomini **535**
- A STRINGERE PER MULTISTRATO --> Ntm **523** - Giacomini **526**
- A STRINGERE PER RAME --> **703**
- IN GHISA ZINCATI --> **513**
- IN OTTONE CROMATI --> **510**
- IN OTTONE GIALLI --> **505**
- IN OTTONE PER CONDIZIONAMENTO --> **706**
- IN OTTONE PER POLIETILENE --> **552**
- IN OTTONE PER SOLARE TERMICO --> **1019**
- IN OTTONE TIPO ROMA --> **405**
- IN POLIETILENE --> A COMPRESSIONE **557** - AD INNESTO **565** - FILETTATI **560**
- IN PPR A SALDARE --> **543**
- IN PPS AD INNESTO --> **605**
- NICHELATI DI RIPARAZIONE --> **520**

Radiatori alluminio --> **921**

Regolatori gas --> **423**

Resistenze scaldabagni --> **1004**

Retrogruppo --> **249**

Ricambi per cassette Pucci --> **19**

Ricambi per elettropompe --> Pedrollo **805** - X-Power **813**

Riduttore di flusso --> **324**

Rilevatore fughe gas --> **425**

### Rosoni

- IN ACCIAIO PER TUBI --> **1109**
- IN GOMMA PER CALDAIE --> **1109**
- IN OTTONE --> **320**
- IN PLASTICA PER RADIATORI --> **916**

Rubinetto cassetta WC --> Geberit **8** - Todini **35** - Oli **37** - CR **37** - Magnetic **38**

### Rubinetti

- GAS --> **417**
- LAVATRICE --> **247**
- OLIO --> **405**
- ORINATOIO --> **222**
- OTTONE GIALLO --> **404**
- PORTAGOMMA --> **401**
- SOTTOLAVABO --> **250**
- TEMPORIZZATO --> **403**

## S

Sale per addolcitori --> **836**

### Sanitari

- BAGNO --> Gravena **101** - Roca **102** - Laneri **103**
- DISABILI --> **107**
- TERZA ETA' --> **106**

# INDICE ANALITICO

Saracinesca ottone --> 412

Sbavatore per tubi --> 638

Sbloccante --> 623

Scaldabagni

A GAS --> 1008

ELETTRICI --> Atlantic 1001 - Chaffoteaux 1002

IN POMPA DI CALORE --> 1020

Scaldasalviette --> 922

Schiuma poliuretana --> 621

Scivolina --> 614

Sedile WC --> 116

Serbatoi

DA INTERRO --> 571

IN POLIETILENE --> 568

ZINCATO --> 821

Sfere plastica per galleggianti --> 432

Shut-off --> 148

Sifoni

CLIMATIZZAZIONE --> 711

IN ABS --> 316

IN ACCIAIO --> 315

IN PLASTICA --> 310

IN OTTONE --> 315

LAVATRICE --> 339

Sigillante gas --> 627

Silicone --> 625

Soffione doccia --> 139

Specchiera simpaty --> 111

Spugna isolamento acustico wc --> 15

Staffa per vaso espansione --> 1018

Staffe per clima --> 715

Sturalavello a molla --> 634

Supporto doccia --> 143

## T

Tagliatubi --> 637

Tangit --> 622

Tappo con rosetta --> 309

Tappo copriforo --> 303

Tappo gomma per lavello --> 302

Tappo per saltarello --> 301

Tappo scattino a griglia --> 304

Tasselli a gancio --> 618

Tasselli fissaggio sanitari --> 124

Teflon --> 627

Telaio per collettore solare --> 1017

Telaio sospeso per cassette --> 14

Termometro digitale --> 641

# INDICE ANALITICO

Termostato a contatto --> 1013

Termostato scaldabagno --> 1006

Trituratore per bagno --> 132

Tronchetti

OTTONE GIALLO --> 508

ZINCATI --> 518

Tubi flessibili carico/scarico per lavatrice --> 338

Tubi flessibili gas --> 427

Tubo

ALTA PRESSIONE --> 837

GOMMA PER GAS GPL E METANO --> 418

IN ACCIAIO PER SOLARE TERMICO --> 1021

IN ACCIAIO ZINCATO --> 519

IN MULTISTRATO --> 521

IN POLIETILENE --> 550

IN PPR AD ELETTROFUSIONE --> 542

IN PPR NERO --> 548

IN RAME --> 701

IN RAME PER CONDIZIONAMENTO --> 710

ISOLANTE --> 702

SEMIRIGIDO PER PISCINA --> 817

SPIRALATO PER CONDENSA CLIMA --> 712

SPIRALATO PER GAS --> 702

Tubo cacciata --> 6

Tubo jolly flex --> 313

## V

Valvole antiriflusso in PVC --> 605

Valvole scarico termico --> 1013

Valvole a sfera

ACCIAIO --> 409

CON BOCCHETTONE --> 410

CON LEVA --> 408

CON MANIGLIA FRONTALE --> 411

GAS --> 415

INCASSO --> 412

MINI --> 406

MOTORIZZATE --> 413

PLASTICA --> 561

Valvole di ritegno --> 501

Valvole di sicurezza MF --> 1014

Valvole di sicurezza per scaldabagni --> 1003

Valvole di sfiato --> 913

Valvole e detentori --> Ivr 901 - Apm 903 - Icma 905 - Giacomini 909

Valvole miscelatrici --> 1015

Vaso espansione --> 1018

Ventilconvettori --> Ventilclima 924 - Olimpia Splendid 926

Vitone

PER PASSO RAPIDO --> 40

PER RUBINETTI --> 41

CASSETTE  
WC E  
SISTEMI DI RISCIACCO

*Tutte le partite partono da 0-0,  
sta nella squadra cambiare il risultato.*

*Zdenèk Zeman*



# CASSETTE WC



# RICAMBI PER CASSETTE WC



# SISTEMI DI RISCIACCO



# PASSI RAPIDI



# VITONI PER RUBINETTI



Rubinetterie Matella Giovanni  
*evolution*



## CASSETTA WC EXPORT

CODICE	DESCRIZIONE	CF	M.V.	PREZZO
00110 0000	1 Pulsante	1	1	€ 31,25



## CASSETTA WC BETA

CODICE	DESCRIZIONE	CF	M.V.	PREZZO
00112 0000	1 Pulsante, 8 Lt	1	1	€ 33,90



## CASSETTA WC BETA CHAMPAGNE

CODICE	DESCRIZIONE	CF	M.V.	PREZZO
00114 0000	1 Pulsante, 8 Lt	5	1	€ 50,70



## CASSETTA WC PLUS

CODICE	DESCRIZIONE	CF	M.V.	PREZZO
00116 0000	1 Pulsante, 8 Lt	1	1	€ 37,25
00118 0000	2 Pulsanti, 8 Lt	1	1	€ 50,77



- Con foderina anticondensa.
- In ABS con trattamento antinvecchiamento.



## CASSETTA WC POLO COMPATTA

CODICE	DESCRIZIONE	CF	M.V.	PREZZO
00121 0000	1 Pulsante	1	1	€ 40,75

- Larga cm 35
- Installazione bassa a zaino o media posizione
- Scocca in ABS con trattamento anti invecchiamento
- Capacità lt 6 con possibilità di regolazione
- Tasto economizzatore d'acqua start/stop
- Coibentazione anticondensa ed isonorizzata
- Allacciamento idrico destro o sinistro
- Galleggiante 3/8 compatto, rapido e silenzioso
- Accessoriata di tubo



## CASSETTA WC CONCEPT PNEUMATICA

CODICE	DESCRIZIONE	CF	M.V.	PREZZO
00122 0000	1 Pulsante, 8 Lt	1	1	€ 118,25

- Con pulsante pneumatico esterno incluso.
- Coibentazione anticondensa e isonorizzante



## CASSETTA WC ALTA

CODICE	DESCRIZIONE	CF	M.V.	PREZZO
00124 0000	C/Coperchio e Catenella	1	1	€ 31,25



## CASSETTA WC AD ANGOLO

CODICE	DESCRIZIONE	CF	M.V.	PREZZO
00126 0000	Start/Stop, 8 Lt.	1	1	€ 94,71

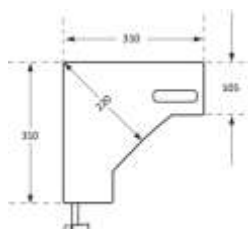

- Senza rubinetto.
- Allacciamento destro, sinistro.



## PULSANTE PNEUMATICO ESTERNO

CODICE	DESCRIZIONE	CF	M.V.	PREZZO
00130 0000	Bianco	1	1	€ 30,80

- Completo di tubetto, canalina rigida e fissaggi



## PULSANTE PNEUMATICO INCASSO A PARETE

CODICE	DESCRIZIONE	CF	M.V.	PREZZO
00132 0000	Bianco	1	1	€ 23,40

- Completo di tubetto e guaina flessibile



## PULSANTE PNEUMATICO A PEDALE

CODICE	DESCRIZIONE	CF	M.V.	PREZZO
00134 0000	Finitura cromata	1	1	€ 96,30

- Pulsante pneumatico esterno  
- Completo di tubetto e guaina flessibile





YOUR SMART  
SOLUTION

Made in  
**ITALY**



45  
ANNIVERSARY



CASSETTE WC ESTERNE



VALVOLE GALLEGGIANTI



SIFONI E PILETTE



SEDILI WC



LAVANDERIA PER ESTERNO

[www.crsmart.it](http://www.crsmart.it)

C.R. SRL - Via dei Liutai 3/5 - 41013 Castelfranco Emilia (MO) Italy - Tel. + 39 059 924 713 - [cr@crsmart.it](mailto:cr@crsmart.it)

## CASSETTA WC IVORY START/STOP 7 LITRI

CODICE	DESCRIZIONE	CF	M.V.	PREZZO
00210 0000	1 Pulsante	1	1	€ 39,12

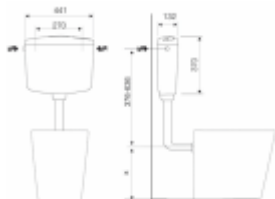

## CASSETTA WC GEMMA START/STOP 6/7 LITRI

CODICE	DESCRIZIONE	CF	M.V.	PREZZO
00212 0000	1 Pulsante	1	1	€ 51,30

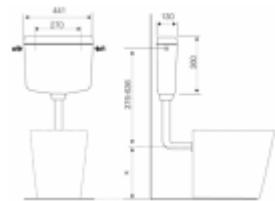

## CASSETTA WC SMERALDO REGOLABILE 4/9 LITRI

CODICE	DESCRIZIONE	CF	M.V.	PREZZO
00214 0000	2 Pulsanti	1	1	€ 71,50

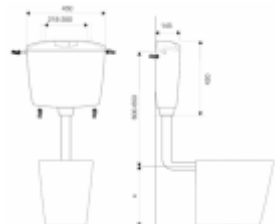

## CASSETTA WC INCASSO SOTTO FINESTRA

CODICE	DESCRIZIONE	CF	M.V.	PREZZO
00224 0000	Doppio scarico 6/3 - 7/3	1	1	€ 209,80

- Attivazione frontale o superiore.

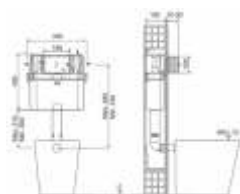

## PLACCA SLIM DUAL

CODICE	DESCRIZIONE	CF	M.V.	PREZZO
00226 0000	Bianca	1	1	€ 75,30
00228 0000	Cromata	1	1	€ 117,20

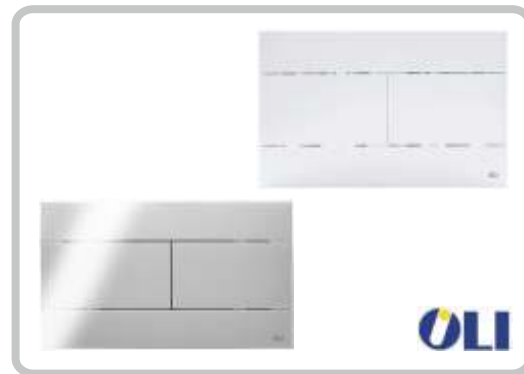



## CASSETTA WC MULTY DUE PULSANTI

CODICE	DESCRIZIONE	CF	M.V.	PREZZO
00310 0000	2 pulsanti	1	1	€ 80,30

Ottima per sostituzione, fissaggio adattabile a quella esistente.



## CASSETTA WC MULTY MONOBLOCCO

CODICE	DESCRIZIONE	CF	M.V.	PREZZO
00312 0100	2 pulsanti - attacco alto	1	1	€ 104,30
00312 0200	2 pulsanti - attacco basso e alto	1	1	€ 137,50

Adatta per sostituzione cassetta monoblocco.



## TUBO CACCIATA PER CASSETTE WC

CODICE	DESCRIZIONE	CF	M.V.	PREZZO
00320 0037	DN 50 x 32 cm 37	1	1	€ 5,70
00320 0060	DN 50 x 32 cm 60	1	1	€ 11,50
00320 0100	DN 50 x 32 cm 100	1	1	€ 12,65



## TUBO DI SCARICO PER CASSETTA WC ALTA

CODICE	DESCRIZIONE	CF	M.V.	PREZZO
00330 0000	DM 32 - KIT 2 pz	1	1	€ 8,90



## TUBO CACCIATA INCASSO

CODICE	DESCRIZIONE	CF	M.V.	PREZZO
00340 0000	45° + 90°	1	1	€ 8,50

## UNICA + Up720 CASSETTA DA INCASSO GEBERIT

CODICE	DESCRIZIONE	RIF. F.	CF	M.V.	PREZZO
00410 0000	Sigma8	109.790.00.1	1	1	€ 273,09



## CASSETTA WC INCASSO GEBERIT COMBIFIX

CODICE	DESCRIZIONE	RIF. F.	CF	M.V.	PREZZO
00411 0000	SIGMA 8 H 109 cm	110.790.00.1	1	1	€ 447,47

- Per wc sospeso, per parete in muratura.



## PLACCA SIGMA BIANCA

CODICE	DESCRIZIONE	CF	M.V.	PREZZO
00412 0000	Geberit sigma 01 bianca	1	1	€ 103,24



## PLACCA SIGMA CROMATA

CODICE	DESCRIZIONE	CF	M.V.	PREZZO
00414 0000	Geberit sigma 01 cromata	1	1	€ 171,68



## PLACCA B-SILENT FLOW 2T

CODICE	DESCRIZIONE	CF	M.V.	PREZZO
00416 0100	Bianca	1	1	€ 51,38
00416 0200	Cromata	1	1	€ 108,30

Compatibile Geberit



# A4 - ACCESSORI CASSETTE WC GEBERIT



## CANOTTO PER CASSETTA GEBERIT

CODICE	DESCRIZIONE	M.V.	M.V.	PREZZO
00418 0000	Canotto d'allacciamento wc	1	1	€ 6,14



## CANOTTO PLASTICA AD «S»

CODICE	DESCRIZIONE	M.V.	M.V.	PREZZO
00419 0000	Ø 40	1	1	€ 7,70



## RUBINETTO A GALLEGGIANTE IMPULS 380

CODICE	DESCRIZIONE	RIF. F.	M.V.	M.V.	PREZZO
00420 0000	3/8	240.783.00.5	1	1	€ 84,95



## CAMPANA COMPLETA TWINCO "TWIN LINE"

CODICE	DESCRIZIONE	RIF. F.	M.V.	M.V.	PREZZO
00422 0000	Doppio scarico	240.502.00.1	1	1	€ 53,00



## CAMPANA COMPLETA TWINCO SIGMA

CODICE	DESCRIZIONE	RIF. F.	M.V.	M.V.	PREZZO
00424 0000	--	241.290.00.1	1	1	€ 53,00



# Pucci & il Bagno una sola anima

« Quando progettiamo un nuovo bagno, ogni elemento dev'essere perfetto, a partire dalla cassetta. Quindi, da costruttore, penso a Pucci. »

« Ne installo davvero tante, di Pucci, mi danno soddisfazione e non deludono mai, neanche dopo un sacco di tempo. »

« Noi architetti siamo concentrati sull'estetica e i dettagli, tra le tante placche Pucci trovo sempre quella giusta per il profilo del cliente. »



CREARE



CASSETTE  
**PUCCI**  
stile e tecnologia italiani

# PUCCI® SARA

RICAMBI ORIGINALI / ORIGINAL SPARE PARTS

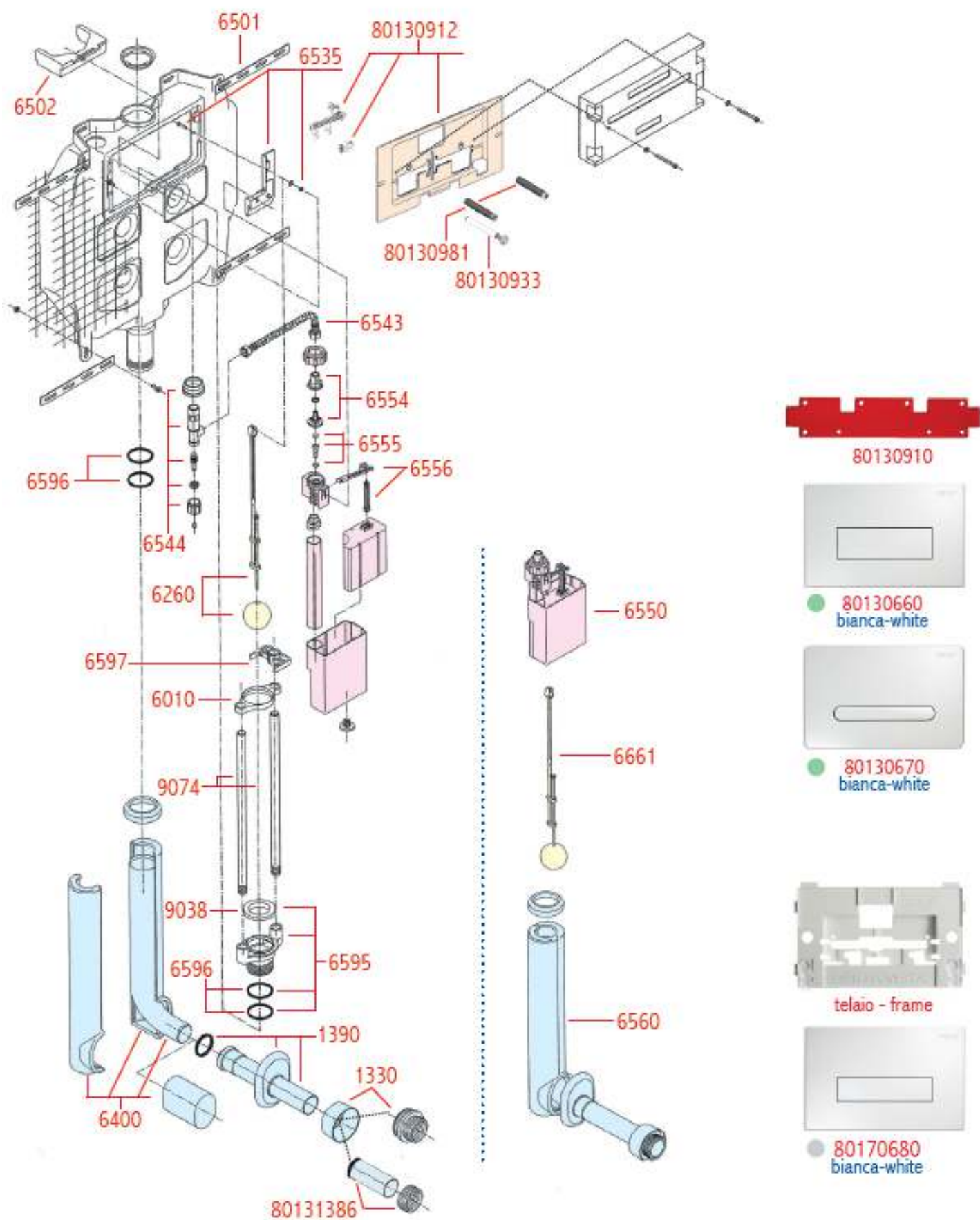

## DESCRIZIONE CODICI RICAMBI ORIGINALI PUCCI SARA

CODICE	Pezzi	DESCRIZIONE
80001330	1	Morsetto combinato Ø 48-58 mm con coprimorsetto - bianco
80001331	1	Morsetto combinato Ø 48-58 mm con coprimorsetto - cromato
80001390	1	Gruppo rosone eccentrico - OR 143 canotto 22 cm - bianco
80001391	1	Gruppo rosone eccentrico - OR 143 canotto 22 cm - cromato
80006010	5	Telaio guida sfera
80006111	1	Sacchetto a corr. alimentazione SARA-eco
80006260	1	Sfera con tirantino
80006261	1	Gruppo completo sfera con astina
80006400	1	Tubo cacciata 35x11 cm Ø 50-40 mm con rivestimento e tappo
80006501	1	4 staffe con bulloni fissaggio cassetta al muro
80006502	5	Distanziatore V95
80006535	2	Staffa sostegno valvola con vite
80006543	1	Flessibile F.F. con guarnizioni
80006544	1	Rubinetto ottone 1/2" con supporto
80006550	1	Gruppo valvola completo
80006554	1	Raccordo valvola con sede interna
80006555	10	Pistoncino con guarnizioni 10x5 mm
80006556	1+1	Leve per valvola
80006560	1	Tubo di risciacquamento 35x11 cm con rivestimento e tappo, regolabile in altezza (+2-2 cm), canotto 22 cm, rosone eccentrico e morsetto combinato Ø 48-58 mm con coprimorsetto - bianco
80006594	1	Sede estraibile completa di tubetti troppo pieno e telaio guida sfera
80006595	1	Sede estraibile con 2 OR 147 e guarnizione sede
80006596	8	OR 147 per sede estraibile e codulo
80006597	5	Telaio distanziatore
80009038	10	Guarnizione sede sfera
80009074	6	Tubetto troppo pieno 47 cm per tutti i modelli
80130660	1	Placca SARA linea bianca 4,7 mm spessore
80130670	1	Placca SARA tratto bianca 4,7 mm spessore
80130910	1	Dima per montaggio vitoni per placca
80130912	1	Sportello SARA
80130930	2+2	Vite registro e vite fissaggio placca prolungate 7 cm
80130933	4	Vite registro
80130981	4	Vite fissaggio placca
80131386	1+1	Manicotto aumento Ø 40-45 mm con OR 143 e morsetto Ø 55-44 mm
80136110	1	Sacchetto a corredo wc SARA-eco
80170680	1	Placca SARA bianca con telaio

# PUCCI<sup>®</sup>eco<sup>®</sup>

RICAMBI ORIGINALI / ORIGINAL SPARE PARTS

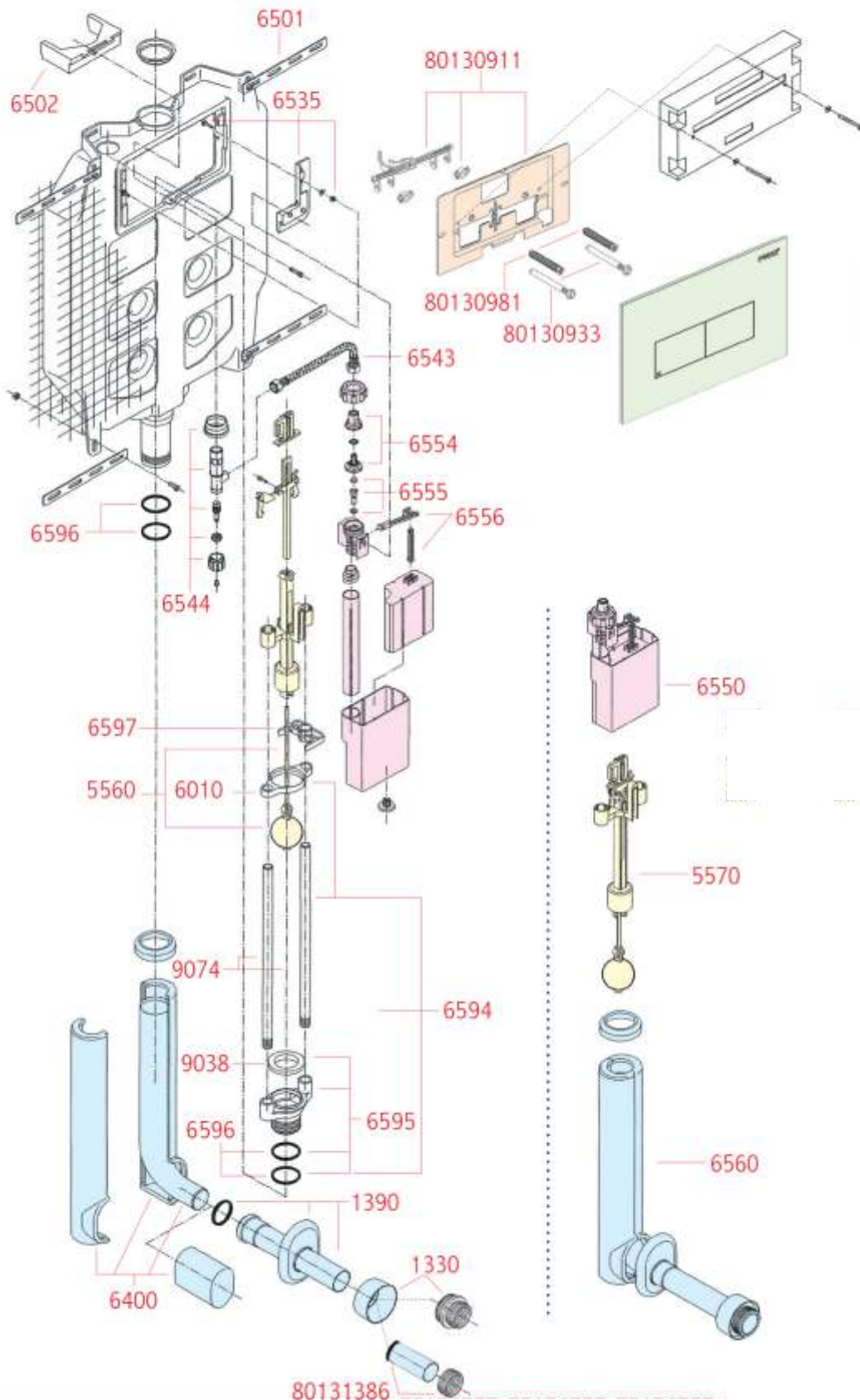

80130910



80130550  
bianca-white



80130560  
bianca-white



80130570  
bianca-white



telaio - frame



80170580  
bianca-white



80180510  
bianca-white

## DESCRIZIONE CODICI RICAMBI ORIGINALI PUCCI ECO

CODICE	Pezzi	DESCRIZIONE
80001330	1	Morsetto combinato Ø 48-58 mm con coprimorsetto - bianco
80001390	1	Gruppo rosone eccentrico - OR 143 canotto 22 cm - bianco
80005560	1	Sfera con tirantino
80005570	1	Batteria completa con sfera
80006010	5	Telaio guida sfera
80006111	1	Sacchetto a corr. alimentazione ECO-SARA
80006400	1	Tubo cacciata 35x11 cm Ø 50-40 mm con rivestimento e tappo
80006501	1	4 staffe con bulloni fissaggio cassetta al muro
80006502	5	Distanziatore V95
80006535	2	Staffa sostegno valvola con vite
80006543	1	Flessibile F.F. con guarnizioni
80006544	1	Rubinetto ottone 1/2" con supporto
80006550	1	Gruppo valvola completo
80006554	1	Raccordo valvola con sede interna
80006555	10	Pistoncino con guarnizioni 10x5 mm
80006556	1+1	Leve per valvola
80006560	1	Tubo di risciacquamento 35x11 cm con rivestimento e tappo, regolabile in altezza (+2-2 cm), canotto 22 cm, rosone eccentrico e morsetto combinato Ø 48-58 mm con coprimorsetto - bianco
80006594	1	Sede estraibile completa di tubetti troppo pieno e telaio guida sfera
80006595	1	Sede estraibile con 2 OR 147 e guarnizione sede
80006596	8	OR 147 per sede estraibile e codulo
80006597	5	Telaio distanziatore
80009038	10	Guarnizione sede sfera
80009074	6	Tubetto troppo pieno 47 cm per tutti i modelli
80130550	1	Placca ECO ellisse bianca 4,7 mm spessore
80130560	1	Placca ECO linea bianca 4,7 mm spessore
80130570	1	Placca ECO tratto bianca 4,7 mm spessore
80130910	1	Dima per montaggio vitoni per placca
80130911	1	Sportello ECO
80130930	2+2	Vite registro e vite fissaggio placca prolungate 7 cm
80130933	4	Vite registro
80131381	4	Vite fissaggio placca
80131386	1+1	Manicotto aumento Ø 40-45 mm con OR 143 e morsetto Ø 55-44 mm
80136110	1	Sacchetto a corredo wc ECO-SARA
80170580	1	Placca ECO bianca con telaio
80180510	1	Placca ECO bianca con telaio

# A5 - CASSETTA WC INCASSO PUCCI E PLACCHE



## CASSETTA INCASSO ECO PUCCI CON 2 PULSANTI 4LT/9LT

CODICE	DESCRIZIONE	RIF. F.	CF	M.V.	PREZZO
00502 0000	2 pulsanti	1315490001	3	1	€ 156,95

- Regolabile in altezza, dotata di canotto 22 cm e rosone eccentrico, rete per intonaco.



## CASSETTA C/TELAIO ECO PUCCI RAPIDO

CODICE	DESCRIZIONE	RIF. F.	CF	M.V.	PREZZO
00503 0000	9 - 4 lt	1322490201	1	1	€ 273,80

- Regolabile in altezza.  
- Per installazioni su pareti in muratura.



## CASSETTA C/TELAIO INCASSO ECO PUCCI MODULO ANTICONDENSA

CODICE	DESCRIZIONE	RIF. F.	CF	M.V.	PREZZO
00504 0000	9 - 4 lt	1323490201	1	1	€ 310,05

- Per installazioni su pareti leggere in cartongesso.



## TELAIO SOSPESO PER WC/BIDET

CODICE	DESCRIZIONE	CF	M.V.	PREZZO
01322 0000	--	1	1	€ 28,75



# A5 - CASSETTE WC INCASSO PUCCI E PLACCHE

## CASSETTA INCASSO SARA PUCCI CON 1 PULSANTE

CODICE	DESCRIZIONE	RIF. F.	CF	M.V.	PREZZO
00501 0000	1 pulsante 9 lt	1315000001	3	1	€ 118,00

- Regolabile in altezza, dotata di cassetto 22 cm e rosone eccentrico, rete per intonaco



## PLACCA SARA MODELLO LINEA

CODICE	DESCRIZIONE	RIF. F.	CF	M.V.	PREZZO
00513 0000	bianca	80130660	3	1	€ 27,00



## PLACCA SARA MODELLO LINEA

CODICE	DESCRIZIONE	RIF. F.	CF	M.V.	PREZZO
00514 0000	cromata	80130662	3	1	€ 54,50



## SPUGNA PER ISOLAMENTO ACUSTICO WC E BIDET SOSPESO

CODICE	DESCRIZIONE	CF	M.V.	PREZZO
01324 0000	420x370x5 - 5 fori	1	1	€ 5,75



# A5 - CASSETTE WC INCASSO PUCCI E PLACCHE



## PLACCA ELLISSE

CODICE	DESCRIZIONE	RIF. F.	CF	M.V.	PREZZO
00516 0000	bianca	80130550	3	1	€ 36,90



## PLACCA ELLISSE

CODICE	DESCRIZIONE	RIF. F.	CF	M.V.	PREZZO
00517 0000	cromata	80130552	3	1	€ 73,00



## PLACCA ELLISSE

CODICE	DESCRIZIONE	RIF. F.	CF	M.V.	PREZZO
00517 0001	cromo satinata	80130559	3	1	€ 80,50

# A5 - CASSETTE WC INCASSO PUCCI E PLACCHE

## PLACCA DOPPIO PULSANTE MOD. LINEA

CODICE	DESCRIZIONE	RIF. F.	CF	M.V.	PREZZO
00510 0000	bianca	80130560	3	1	€ 36,90

- Spessore ridotto 4,7 mm - 180x280



## PLACCA DOPPIO PULSANTE MOD. LINEA

CODICE	DESCRIZIONE	RIF. F.	CF	M.V.	PREZZO
00511 0000	cromata	80130562	3	1	€ 73,00

- Spessore ridotto 4,7 mm - 180x280

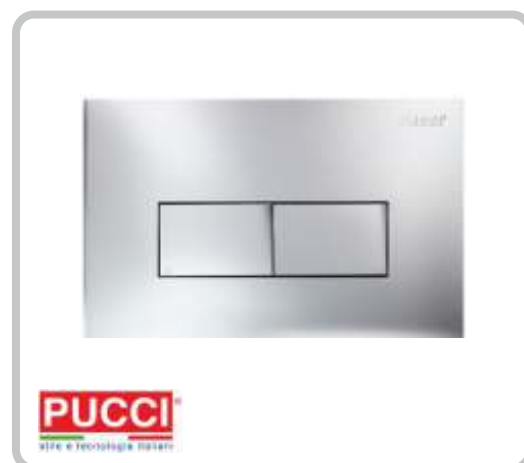

## PLACCA DOPPIO PULSANTE MOD. LINEA

CODICE	DESCRIZIONE	RIF. F.	CF	M.V.	PREZZO
00511 0001	cromo satinata	80130569	3	1	€ 80,50

- Spessore ridotto 4,7 mm - 180x280

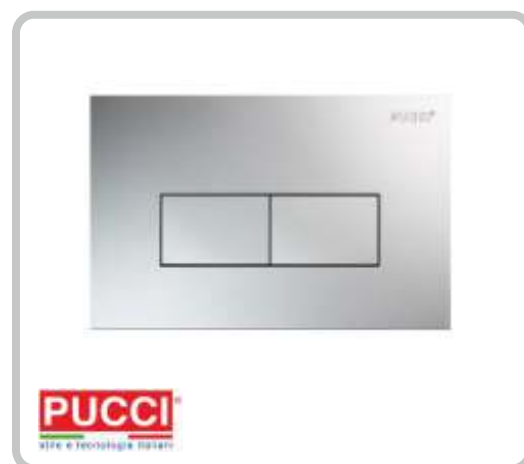

## PLACCA DOPPIO PULSANTE MOD. LINEA

CODICE	DESCRIZIONE	RIF. F.	CF	M.V.	PREZZO
00512 0000	nero opaco	80230561	3	1	€ 128,75

Spessore ridotto 4,7 mm - 180x280



# A5 - ACCESSORI PER CASSETTE WC PUCCI



## KIT ECO 310 PER PLACCHE 330x180

CODICE	DESCRIZIONE	RIF. F.	CF	M.V.	PREZZO
00518 0100	bianca	80179560	1	1	€ 87,18
00518 0200	cromata	80179562	1	1	€ 122,00

- Placca completa di telaio e sportello. Spessore 12 mm.



## KIT SARA 310 PER PLACCHE 330x180

CODICE	DESCRIZIONE	RIF. F.	CF	M.V.	PREZZO
00519 0100	bianca	80179660	1	1	€ 75,39
00519 0200	cromata	80179662	1	1	€ 111,00

- Placca completa di telaio e sportello. Spessore 12 mm.



## KIT ECO 280 PER PLACCHE 280 X 180

CODICE	DESCRIZIONE	RIF. F.	CF	M.V.	PREZZO
00520 0100	Bianca	80179580	1	1	€ 87,18
00520 0200	Cromata	80179582	1	1	€ 122,00

- Placca completa di telaio e sportello. Spessore 12 mm.



## KIT SARA 280 PER PLACCHE 280 X 180

CODICE	DESCRIZIONE	RIF. F.	CF	M.V.	PREZZO
00523 0100	Bianca	80179680	1	1	€ 75,39
00523 0200	Cromata	80179682	1	1	€ 111,00

- Placca completa di telaio e sportello. Spessore 12 mm.



## SPORTELLO PER CASSETTE DA 2002 AL 2010

CODICE	DESCRIZIONE	RIF. F.	CF	M.V.	PREZZO
00521 0100	per cassetta ECO	80005541	1	1	€ 69,60
00521 0200	per cassetta SARA	80006240	1	1	€ 20,42

- Completo di viti di registro.



## SPORTELLO PER CASSETTE DA SETTEMBRE 2013

CODICE	DESCRIZIONE	RIF. F.	CF	M.V.	PREZZO
00522 0100	per cassetta ECO	80130911	1	1	€ 43,25
00522 0200	per cassetta SARA	80130912	1	1	€ 35,45

- Completo di viti di registro.



## RIDUTTORE DI PORTATA PER SEDE ESTRAIBILE

CODICE	DESCRIZIONE	CF	M.V.	PREZZO
00540 0000	DM 40 x 30 + DM 40 x 25	1	1	€ 22,84



## MORSETTO COMBINATO C/COPRIMORSETTO

CODICE	DESCRIZIONE	RIF. F.	CF	M.V.	PREZZO
00546 0000	bianco 58x48	80001330	1	1	€ 9,85



# A6 - RICAMBI PER CASSETTE WC PUCCI



## PLACCA CIECA

CODICE	DESCRIZIONE	RIF. F.	CF	M.V.	PREZZO
00524 0000	bianca	80009066	1	1	€ 21,40



## COMANDO A PARETE PER MONTAGGIO ESTERNO

CODICE	DESCRIZIONE	RIF. F.	CF	M.V.	PREZZO
00526 0000	per Sara pneumatica	80009900	1	1	€ 51,00



## BATTERIA PNEUMATICA PER CASSETTA SARA

CODICE	DESCRIZIONE	RIF. F.	CF	M.V.	PREZZO
00528 0000	Pneumatica per cassetta Sara	80009970	1	1	€ 54,00



## SFERA CON TIRANTINO

CODICE	DESCRIZIONE	RIF. F.	CF	M.V.	PREZZO
00529 0000	Cassetta Sara	80006261	1	1	€ 19,33

## TELAIO GUIDA SFERA

CODICE	DESCRIZIONE	RIF. F.	CF	M.V.	PREZZO
00530 0000	Cassetta Sara/Eco	80006010	1	1	€ 10,80



## SFERA CON TIRANTINO

CODICE	DESCRIZIONE	RIF. F.	CF	M.V.	PREZZO
00532 0000	Cassetta Eco	80005560	1	1	€ 14,80



## BATTERIA COMPLETA DI SFERA

CODICE	DESCRIZIONE	RIF. F.	CF	M.V.	PREZZO
00534 0000	per cassette Eco	80005570	1	1	€ 57,50



## SEDE ESTRAIBILE COMPLETA DI TUBI TROPPO PIENO E TELAIIO GUIDA

CODICE	DESCRIZIONE	RIF. F.	CF	M.V.	PREZZO
00536 0000	Casetta Eco	80006594	1	1	€ 28,00

- Composto da:

- > 8000 6595 sede estraibile
- > 8000 9074 tubo troppo pieno
- > 8000 6010 telaio guida sfera



# A6 - RICAMBI PER CASSETTE WC PUCCI



## GALLEGGIANTE PER CASSETTA RAME "SICILIA" PULSANTE BASSO

CODICE	DESCRIZIONE	RIF. F.	CF	M.V.	PREZZO
00560 0000	Attacco laterale	80009150	1	1	€ 42,00



## GALLEGGIANTE CON VASCHETTA PER CASSETTA RAME PULSANTE BASSO

CODICE	DESCRIZIONE	RIF. F.	CF	M.V.	PREZZO
00562 0000	Attacco laterale	80009151	1	1	€ 48,95

- Vaschetta da ordinare a parte.



## GALLEGGIANTE CON VASCHETTA PER CASSETTE SARA (87-95)

CODICE	DESCRIZIONE	RIF. F.	CF	M.V.	PREZZO
00564 00000	Attacco superiore	80009251	1	1	€ 46,70

- Articolo uguale a 8000 6150



## VASCHETTA PER GALLEGGIANTE 80009151 E 80009251

CODICE	DESCRIZIONE	RIF. F.	CF	M.V.	PREZZO
00568 0000	--	80009535	1	1	€ 9,10



## STAFFA SOSTEGNO PER VASCHETTA 80009535

CODICE	DESCRIZIONE	RIF. F.	CF	M.V.	PREZZO
00569 0000	--	80009536	1	1	€ 14,80

## PISTONCINO PER PULSANTE BASSO METALLO

CODICE	DESCRIZIONE	RIF. F.	CF	M.V.	PREZZO
00570 0000	Cassetta rame	80009030	1	1	€ 11,30



**PUCCI**  
80° e Tecnologia Italiana

## PULSANTE COMPLETO BASSO METALLO

CODICE	DESCRIZIONE	RIF. F.	CF	M.V.	PREZZO
00572 0000	Cassetta rame	80009034	1	1	€ 50,75



**PUCCI**  
80° e Tecnologia Italiana

## PISTONCINO PER VALVOLA 80006550

CODICE	DESCRIZIONE	RIF. F.	CF	M.V.	PREZZO
00574 0000	Cassetta 6/8 plastica	80009035	1	1	€ 33,50



**PUCCI**  
80° e Tecnologia Italiana

## ROSONE E BOCCOLA PER PULSANTE BASSO

CODICE	DESCRIZIONE	RIF. F.	CF	M.V.	PREZZO
00576 0000	--	80009033	1	1	€ 11,90



**PUCCI**  
80° e Tecnologia Italiana

# A6 - RICAMBI PER CASSETTE WC PUCCI



## VALVOLA COMPLETA PER CASSETTE PUCCI SARA ECO

CODICE	DESCRIZIONE	RIF. F.	CF	M.V.	PREZZO
00550 0000	Sara/Eco	80006550	1	1	€ 40,70



## STAFFA PER VALVOLA 80006550

CODICE	DESCRIZIONE	RIF. F.	CF	M.V.	PREZZO
00552 0000	--	80006535	1	1	€ 8,70



## PISTONCINO PER VALVOLA 80006550

CODICE	DESCRIZIONE	RIF. F.	CF	M.V.	PREZZO
00554 0000	--	80006555	10	1	€ 24,50*

\* prezzo riferito alla confezione da 10 pezzi.



## SFERA DI TENUTA PER CASSETTA RAME PULSANTE BASSO

CODICE	DESCRIZIONE	RIF. F.	CF	M.V.	PREZZO
00556 0000	--	80009039	1	1	€ 11,60

# A7 - MEMBRANE PER CASSETTE WC

## MEMBRANA

CODICE	DESCRIZIONE	RIF. F.	CF	M.V.	PREZZO
00542 0000	dm 60x44 - H 10,5	80009038	10	10	€ 2,75



## MEMBRANA

CODICE	DESCRIZIONE	RIF. F.	CF	M.V.	PREZZO
00543 0000	compatibile PUCCI	1037000000	25	1	€ 2,20



## MEMBRANA DI FONDO MAMOLI

CODICE	DESCRIZIONE	CF	M.V.	PREZZO
00604 0000	69 x 40	25	1	€ 1,65



## MEMBRANA DI FONDO PER CASSETTA MAMOLI VECCHIO TIPO

CODICE	DESCRIZIONE	CF	M.V.	PREZZO
00605 0000	Ø 70	10	1	€ 3,00



## A7 - MEMBRANE PER CASSETTE WC



### MEMBRANA DI FONDO PIANA IN PARA

CODICE	DESCRIZIONE	CF	M.V.	PREZZO
00609 0000	60 x 23,8 x 2,7 OLIVER	25	1	€ 1,90



### MEMBRANA DI FONDO PIANA IN PARA

CODICE	DESCRIZIONE	CF	M.V.	PREZZO
00612 0000	63 x 30 x 3 BETA	25	1	€ 1,88



### MEMBRANA DI FONDO PIANA IN PARA

CODICE	DESCRIZIONE	CF	M.V.	PREZZO
00606 0000	58 x 32 x 3 GEBERIT	25	1	€ 2,09
00607 0000	63 x 23 x 3 GEBERIT	10	1	€ 2,09

# A7 - MEMBRANE PER CASSETTE WC

## MEMBRANA DI FONDO PER CASSETTE WC MULTY

CODICE	DESCRIZIONE	CF	M.V.	PREZZO
00610 0000	Bampi	10	1	€ 2,50



## MEMBRANA DI FONDO PER CASSETTA KARIBA

CODICE	DESCRIZIONE	CF	M.V.	PREZZO
00614 0000	61 x 22 x 12,5	1	1	€ 3,00



## MEMBRANA DI FONDO RAMO

CODICE	DESCRIZIONE	CF	M.V.	PREZZO
00616 0000	Ø 62,5 x 50 mm	1	1	€ 1,46



## FUNGO COMPLETO PER CASSETTA RAMO

CODICE	DESCRIZIONE	CF	M.V.	PREZZO
00618 0000	asta + beccuccio	1	1	€ 18,09



# A7 - MEMBRANE PER CASSETTE WC

**New**



## CAMPANA PER BATTERIA TREMOLADA

CODICE	DESCRIZIONE	CF	M.V.	PREZZO
00600 0000	--	1	1	€ 32,70



## MEMBRANA A SOFFIETTO TIPO TREMOLADA

CODICE	DESCRIZIONE	CF	M.V.	PREZZO
00602 0000	in para nera	25	1	€ 2,59



## MEMBRANA DI FONDO PIANA IN PARA

CODICE	DESCRIZIONE	CF	M.V.	PREZZO
00608 0000	63 x 24,8 x 3,6 TREMOLADA	25	1	€ 1,41



## MEMBRANA WC TREMOLADA A FUNGHETTO

CODICE	DESCRIZIONE	CF	M.V.	PREZZO
00615 0000	69 x 22,5	10	1	€ 4,10

## SIFONE STANDARD CATIS

CODICE	DESCRIZIONE	RIF. F.	CF	M.V.	PREZZO
00650 0000	Solo sifone	D1010	10	1	€ 79,75

- Per cassetta alta
- Corpo in ghisa e particolari in ottone, gomma e plastica

Disponibile da giugno.



**New**

## PULSANTE PER BATTERIA CATIS

CODICE	DESCRIZIONE	RIF. F.	CF	M.V.	PREZZO
00652 0000	Incasso	D1030	10	1	€ 67,0

- Finitura cromo
- Tubo in rame incluso
- cm 145

Disponibile da giugno.



**New**

## MINI SFERA CON NOTTOLINO IN OTTONE FILETTO M4

CODICE	DESCRIZIONE	CF	M.V.	PREZZO
00619 0000	Ø 34x29	10	1	€ 2,20

- Per cassetta tipo catis.



## GALLEGGIANTE TIPO CATIS

CODICE	DESCRIZIONE	CF	M.V.	PREZZO
04711 0300	3/8	1	1	€ 10,56
04711 0400	1/2	1	1	€ 12,90

- Sfere a pagina 432.



**FARG**



# OLI

“La nostra visione del futuro  
bellezza, innovazione  
e rispetto per l’ambiente.”

## SOLUZIONI INTEGRATE

Il bagno come uno spazio che unisce l’efficienza idrica al design, focalizzandosi sulla funzionalità. Una gamma completa di prodotti per bagni in progetti esigenti.



## ESPLOSO E RICAMBI BATTERIA UNIBOX

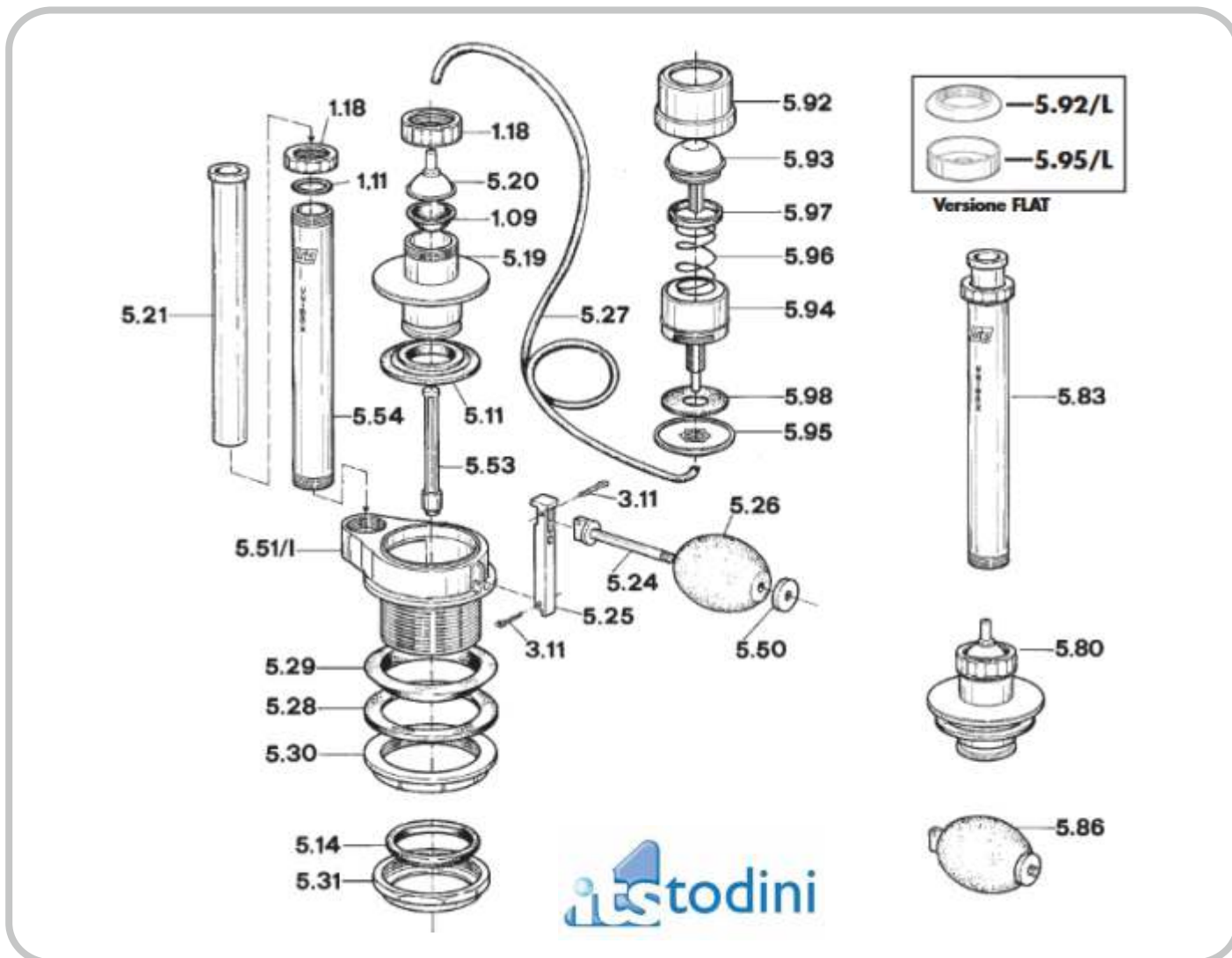

- |   |   |   |
|---|---|---|
| 1.09 Cappello di sollevamento<br><i>Lift up cap</i>                 | 5.29 Guarnizione conica 2"<br><i>2" tapered packing</i>   | 5.95 Dado di serraggio del gruppo di comando<br><i>Control unit locknut</i>               |
| 1.11 O-ring di tenuta del sopravanzo<br><i>Overflow o ring seal</i> | 5.30 Ghiera di serraggio della cassetta<br><i>Cistern locknut</i>                                     | 5.95/L Distanziale flat<br><i>Spacer flat</i>   |
| 1.18 Ghiera di serraggio<br><i>Locknut</i>                          | 5.31 Ghiera di serraggio del tubo $\varnothing$ 50<br><i><math>\varnothing</math> 50 tube locknut</i> | 5.96 Molla inox<br><i>Stainless steel spring</i>  |
| 3.11 Coppiglia inox<br><i>Stainless steel split pin</i>             | 5.50 Contropeso<br><i>Counter weight</i>  | 5.97 Guarnizione di tenuta del pulsante<br><i>Push-button seal packing</i>                |
| 5.11 Membrana di chiusura<br><i>Water closure packing</i>           | 5.51/l Base con sede inox<br><i>Base with stainless steel seat</i>                                    | 5.98 Guarnizione piana $\varnothing$ 40<br><i><math>\varnothing</math>40 flat packing</i> |
| 5.14 Guarnizione premistoppa<br><i>Boot packing</i>                 | 5.53 Perno di sollevamento<br><i>Lift-up guide pin</i>  |   |
| 5.19 Campana<br><i>Shetter</i>                                      | 5.54 Tubo inferiore del sopravanzo<br><i>Lower overflow tube</i>                                      |   |
| 5.20 Cupoletta presa aria<br><i>Air dome</i>                        | 5.80 Campana completa<br><i>Complete Shut off valve</i>   |   |
| 5.21 Tubo sopravanzo telescopico<br><i>Upper overflow tube</i>      | 5.83 Sopravanzo telescopico<br><i>Telescopic overflow</i>   |   |
| 5.24 Perno di bloccaggio<br><i>Lock pin</i>                         | 5.86 Gruppo di galleggiamento<br><i>Floating unit</i>   |   |
| 5.25 Leva di bloccaggio<br><i>Lock lever</i>                        | 5.92 Borchia del gruppo di comando<br><i>Control unit cover</i>                                       |   |
| 5.26 Galleggiante di polistirolo<br><i>Polystyrene float</i>        | 5.92/L Borchia flat<br><i>Boss flat</i>   |   |
| 5.27 Tubo flessibile PVC<br><i>PVC flexible tube</i>                | 5.93 Pulsante del gruppo di comando<br><i>Control unit push-button</i>                                |   |
| 5.28 Guarnizione piana 2"<br><i>2" flat packing</i>                 | 5.94 Cilindro del gruppo di comando<br><i>Control unit cylinder</i>                                   |   |

\* Per i prezzi dei ricambi consultare il Listino Generale in fondo al catalogo  
 \* For prices of spare parts consult the General Price list at the end pages of this Catalogue.



## CAMPANA COMPLETA - 5.80

CODICE	DESCRIZIONE	CF	M.V.	PREZZO
00702 0000	Per batterie di scarico Unibox	1	1	€ 26,37



## MEMBRANA DI SOLLEVAMENTO A CAPPELLOTTO - 1.09

CODICE	DESCRIZIONE	CF	M.V.	PREZZO
00704 0000	Per batteria di scarico Unibox	25	1	€ 2,73



## MEMBRANA DI CHIUSURA - 5.11

CODICE	DESCRIZIONE	CF	M.V.	PREZZO
00706 0000	Per batteria di scarico Unibox	25	1	€ 2,09



## GHIERA DI SERRAGGIO + CUPOLETTA PRESA ARIA

CODICE	DESCRIZIONE	RIF. F.	CF	M.V.	PREZZO
00708 0000	per batteria di scarico Unibox	1.18 + 5.20	1	1	€ 5,71

## TUBO FLESSIBILE IN PVC - 5.27

CODICE	DESCRIZIONE	CF	M.V.	PREZZO
00712 0000	Per batteria di scarico Unibox	1	1	€ 3,95



## TUBO FLESSIBILE IN PVC - 5.27R

CODICE	DESCRIZIONE	CF	M.V.	PREZZO
00714 0000	Per batteria di scarico Unibox mm 430 rosso	1	1	€ 2,15



## PULSANTE UNIBOX - 5.91

CODICE	DESCRIZIONE	CF	M.V.	PREZZO
00716 0000	Cromo	1	1	€ 16,05

- Nuova versione



## GRUPPO DI GALLEGGIAMENTO - 5.86

CODICE	DESCRIZIONE	CF	M.V.	PREZZO
00718 0000	--	1	1	€ 8,70





## PERNO DI SOLLEVAMENTO UNIBOX + LEVA DI BLOCCAGGIO

CODICE	DESCRIZIONE	RIF. F.	CF	M.V.	PREZZO
00720 0000	--	5.74/2	1	1	€ 5,00

- Ex articolo 5.25 + 5.53.



## SOPRAVANZO TELESCOPICO UNIBOX - 5.83

CODICE	DESCRIZIONE	CF	M.V.	PREZZO
00722 0000		1	1	€ 11,88



## COMPLETO PER CASSETTA MONOBLOCCO - 5.01

CODICE	DESCRIZIONE	CF	M.V.	PREZZO
00724 0000	Guarnizione di supporto tipo A125x85 mm Coppia di viti di ottone complete di guarnizioni e rondelle inox	1	1	€ 17,96



## GUARNIZIONE PER BATTERIA TODINI

CODICE	DESCRIZIONE	CF	Q.tà	PREZZO
00725 0000	Senza fissaggi	1	1	€ 6,15

## BATTERIA UNIBOX - 5.06

CODICE	DESCRIZIONE	CF	M.V.	PREZZO
00726 0000	Centrale e pulsante	10	1	€ 104,16



## BATTERIA WC IN PVC TODINI

CODICE	DESCRIZIONE	RIF. F.	CF	M.V.	PREZZO
00728 0000	Doppio scarico	4.00+5.01	10	1	€ 44,47



## GALLEGGIANTE BASSO TODINI

CODICE	DESCRIZIONE	RIF. F.	CF	M.V.	PREZZO
00814 0000	3/8	2.01/TO	1	1	€ 29,00



## GALLEGGIANTE UNIVERSALE ALTO/BASSO TODINI

CODICE	DESCRIZIONE	RIF. F.	CF	M.V.	PREZZO
00815 0000	3/8	2.01/TU	10	1	€ 29,00

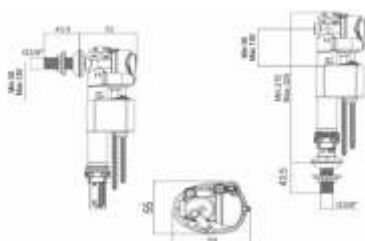

# A10 - BATTERIE E RUBINETTI PER CASSETTA WC



## BATTERIA WC IN PVC

CODICE	DESCRIZIONE	CF	M.V.	PREZZO
00800 0000	2 pulsanti. Con filo in acciaio.	1	1	€ 50,00



## BATTERIA WC IN PVC AD ARIA

CODICE	DESCRIZIONE	CF	M.V.	PREZZO
00802 0000	pneumatica	10	1	€ 19,25

- Completa di galleggiante attacco laterale.



## GALLEGGIANTE BASSO CR

CODICE	DESCRIZIONE	CF	M.V.	PREZZO
00812 0300	attacco 3/8 ottone	30	1	€ 22,55
00812 0400	attacco 1/2 ottone	30	1	€ 22,55



## RUBINETTO ATTACCO BASSO PER CASSETTA

CODICE	DESCRIZIONE	CF	M.V.	PREZZO
04712 0300	3/8	1	1	€ 21,60
04712 0400	1/2	1	1	€ 22,95

- Sfera plastica Ø 90 cod. 04721 0090 a pag. 223.

# A10 - BATTERIE E RUBINETTI PER CASSETTA WC OLI

## OLI ONE - GALLEGGIANTE PER OGNI TIPO DI CASSETTA

CODICE	DESCRIZIONE	CF	M.V.	PREZZO
00822 0000	3/8	1	1	€ 26,75

- Efficace con qualsiasi pressione.
- Elevate prestazioni con acqua dura e con residui sabbiosi.
- Adattatori multimarca.



## IVC 100 PLUS - ATTACCO BASSO E LATERALE

CODICE	DESCRIZIONE	CF	M.V.	PREZZO
00824 0000	3/8	1	1	€ 27,40

- Altezza regolabile.



## OLI REPLACE - COMPATIBILE CATIS

CODICE	DESCRIZIONE	CF	M.V.	PREZZO
00826 0000	H 210	1	1	€ 53,50

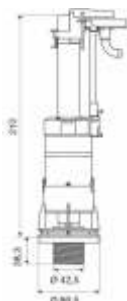

## GALLEGGIANTE ATTACCO BASSO E LATERALE CR

CODICE	DESCRIZIONE	CF	M.V.	PREZZO
00816 0000	3/8; 1/2	30	1	€ 21,25
00816 0300	3/8 ottone	30	1	€ 23,75

- Funzionamento in contropressione
- Attacco idrico laterale e basso
- Attacco 1/2 e 3/8
- Rumorosità inferiore a 20 decibel
- Corpo telescopico ad alta regolazione
- Filtro anti-impurità facilmente ripulibile

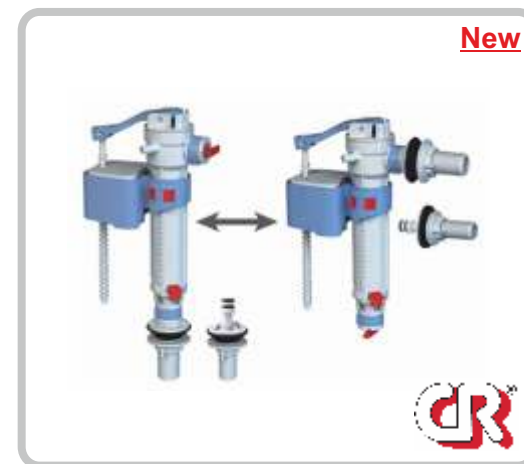

# A10 - RUBINETTI PER CASSETTA WC



## GALLEGGIANTE ALTO

CODICE	DESCRIZIONE	CF	M.V.	PREZZO
00832 0000	3/8	1	1	€ 9,50



## GALLEGGIANTE ALTO BLACK RAMBO

CODICE	DESCRIZIONE	CF	M.V.	PREZZO
00833 0000	3/8 - Ottone	12	1	€ 13,10



## GALLEGGIANTE ATTACCO ALTO NANOTEK

CODICE	DESCRIZIONE	CF	M.V.	PREZZO
00836 0000	3/8 in ottone	14	1	€ 20,15

- Inclusi adattatori per cassetta incasso PUCCI e GEBERIT.



## GALLEGGIANTE SILENZIOSO UNIVERSALE MAGNETIC

CODICE	DESCRIZIONE	CF	M.V.	PREZZO
00838 0000	3/8	25	1	€ 27,10



## PASSO RAPIDO INCASSO

CODICE	DESCRIZIONE	RIF. F.	CF	M.V.	PREZZO
00902 0000	1" cromato	1505001000C	1	1	€ 58,70



## PASSO RAPIDO ESTERNO

CODICE	DESCRIZIONE	RIF. F.	CF	M.V.	PREZZO
00904 0000	1" cromato	1510001000C	2	2	€ 54,00



## PIASTRA RETTANGOLARE PER PASSO RAPIDO INCASSO

CODICE	DESCRIZIONE	RIF. F.	CF	M.V.	PREZZO
00906 0000	5 mm inox	15500050001	20	1	€ 3,60



## LEVA + GHIERA + PLACCHETTA PER PASSO RAPIDO INCASSO

CODICE	DESCRIZIONE	RIF. F.	CF	M.V.	PREZZO
00908 0000	Incasso	1530000000C	1	1	€ 16,90



## TUBO A «L» GIALLO PER PASSO RAPIDO INCASSO

CODICE	DESCRIZIONE	CF	M.V.	PREZZO
00911 0000	cm 63/75	1	1	€ 39,70

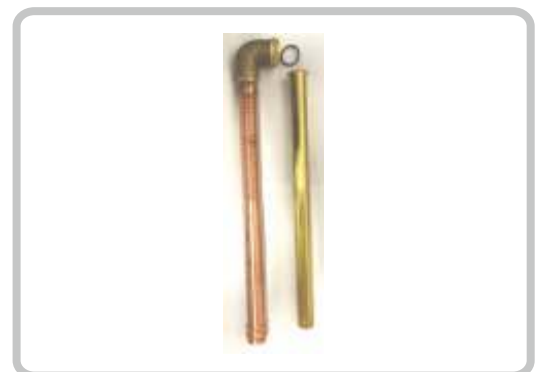

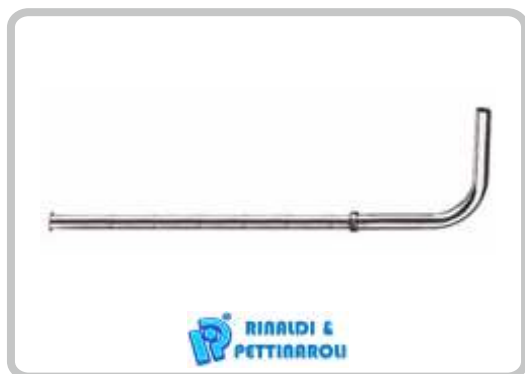

## TUBO A «L» PER PASSO RAPIDO

CODICE	DESCRIZIONE	CF	M.V.	PREZZO
00910 0000	1"	1	1	€ 33,40

- Con regolazione bassa.



## VITONE PER PASSO RAPIDO INCASSO

CODICE	DESCRIZIONE	CF	M.V.	PREZZO
00920 2700	Ø 27	5	1	€ 14,70
00920 2800	Ø 28	5	1	€ 14,70
00920 2900	Ø 29	5	1	€ 14,70



## VITONE PER PASSO RAPIDO ASTA LUNGA

CODICE	DESCRIZIONE	CF	M.V.	PREZZO
00921 2700	Ø 27	5	1	€ 17,50
00921 2800	Ø 28	5	1	€ 17,50
00921 2900	Ø 29	5	1	€ 17,50



## VITONE PER PASSO RAPIDO ESTERNO

CODICE	DESCRIZIONE	CF	M.V.	PREZZO
00922 2700	Ø 27	5	1	€ 14,30
00922 2800	Ø 28	5	1	€ 14,30



## KIT RIPARAZIONE PER FLUSSOMETRO

CODICE	DESCRIZIONE	CF	M.V.	PREZZO
00930 0000	DM 27-28-29-30	1	1	€ 38,50



# A12 - VITONI DI RICAMBIO PER RUBINETTI

## KIT VITONI UNIVERSALI

CODICE	DESCRIZIONE	CF	M.V.	PREZZO
00932 0000	1" . 1/4 X 32	1	1	€ 17,50



## GUARNIZIONE RICAMBIO FORATA PER VITONE

CODICE	DESCRIZIONE	CF	M.V.	PREZZO
00933 0003	3/8	100	10	€ 0,13
00933 0004	1/2	100	10	€ 0,13
00933 0005	3/4	100	10	€ 0,13
00933 0006	1"	50	10	€ 0,13



## VITONE CERAMICO 1/2 BROCCIA Ø 8x24 MILLERIGHI

CODICE	DESCRIZIONE	CF	M.V.	PREZZO
00935 0001	DX - Acqua fredda - VCA12090DA001	10	1	€ 11,20
00935 0002	SX - Acqua calda	10	1	€ 11,20

- Q:19,5

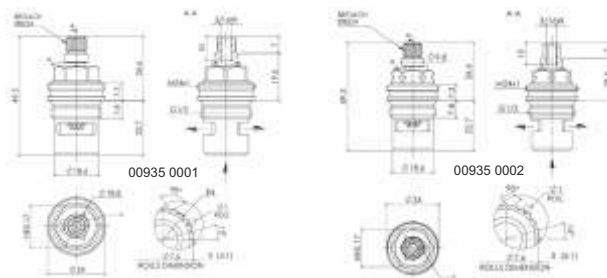

## VITONE CERAMICO 1/2 BROCCIA Ø 7,8x20 MILLERIGHI

CODICE	DESCRIZIONE	CF	M.V.	PREZZO
00934 0001	DX - Acqua fredda - VCA12090DA004	10	1	€ 11,50
00934 0002	SX - Acqua calda	10	1	€ 11,50

- Q:20

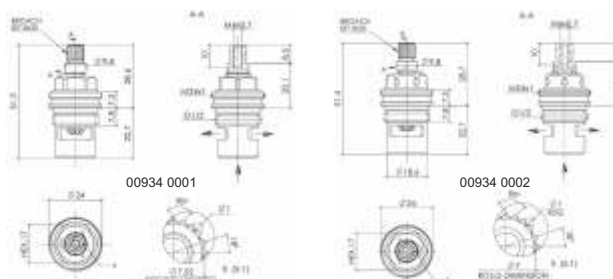

# A12 - VITONI DI RICAMBIO PER RUBINETTI



## VITONE 1/2 CON BROCCIA Ø 7,8x20 MILLERIGHI

CODICE	DESCRIZIONE	RIF. F.	CF	M.V.	PREZZO
00936 0000	--	VDS12004NB001	1	1	€ 8,50

- Q:18,6

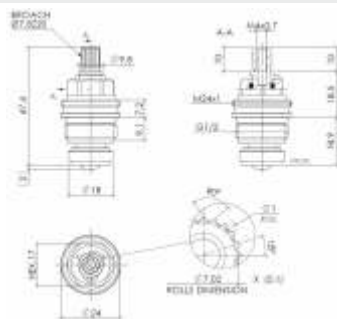

## VITONE 1/2 CON BROCCIA Ø 8x24 MILLERIGHI

CODICE	DESCRIZIONE	RIF. F.	CF	M.V.	PREZZO
00937 0000	--	VDS12004NB005	1	1	€ 8,50

- Q:19,5

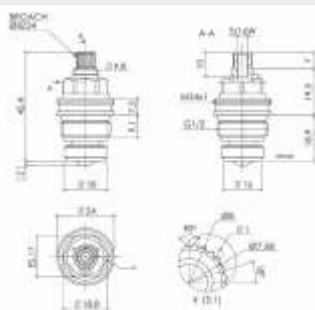

## VITONE 1/2 BROCCIA Ø 7,8x18 MILLERIGHI

CODICE	DESCRIZIONE	RIF. F.	CF	M.V.	PREZZO
00938 0000	--	VDS12004NB063	5	1	€ 11,20

- Per rubinetti Cristina - Painsi - Nobili  
- Q:18,9

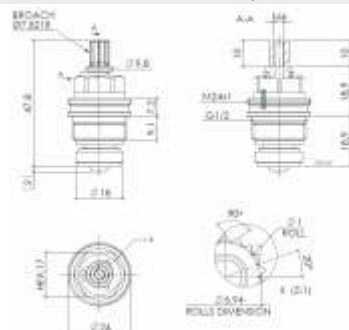

## VITONE 1/2 BROCCIA Ø 9x20 MILLERIGHI

CODICE	DESCRIZIONE	RIF. F.	CF	M.V.	PREZZO
00939 0000	Frattoni	VDS12004NB029	5	1	€ 9,30

- Q:21,5

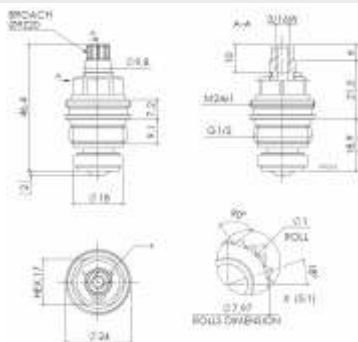

# A12 - VITONI DI RICAMBIO PER RUBINETTI

## VITONE CERAMICO 1/2 BROCCIA Ø 7,8x18 MILLERIGHI

CODICE	DESCRIZIONE	RIF. F.	CF	M.V.	PREZZO
00947 0001	DX - Acqua fredda	VCA12-090DA-120S01	10	1	€ 16,70
00947 0002	SX - Acqua calda	VCA12-090SA-120S01	10	1	€ 16,70

- Zucchetti  
- Q:18,9

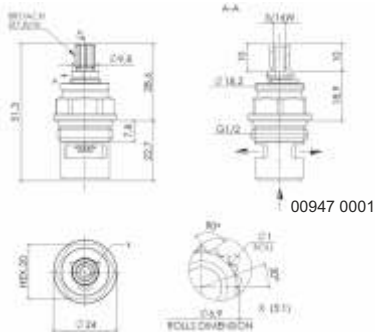

## VITONE CERAMICO 1/2 BROCCIA Ø 9x20 MILLERIGHI

CODICE	DESCRIZIONE	RIF. F.	CF	M.V.	PREZZO
00945 0001	DX - Acqua fredda	VCA12090DA056	10	1	€ 14,20
00945 0002	SX - Acqua calda	VCA12095DA056	10	1	€ 14,20

- Frattini  
- Q:20,7

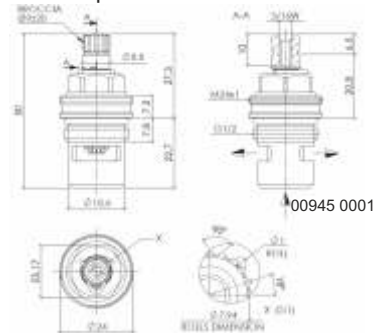

## VITONE 1/2 BROCCIA Ø 8,2x20 MILLERIGHI

CODICE	DESCRIZIONE	RIF. F.	CF	M.V.	PREZZO
00941 0000	Paffoni	VDS12004NB139	10	1	€ 9,30

- Q:20,5

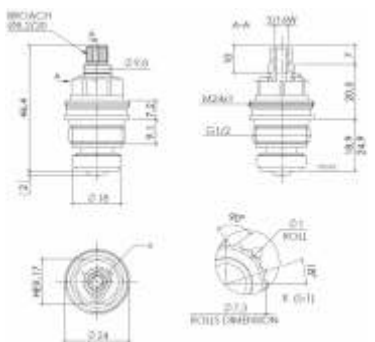

## VITONE 1/2 BROCCIA Ø 9,2x20 MILLERIGHI

CODICE	DESCRIZIONE	RIF. F.	CF	M.V.	PREZZO
00942 0000	GS Gnutti	VDS12004NB049	10	1	€ 9,30

- Q:19,5

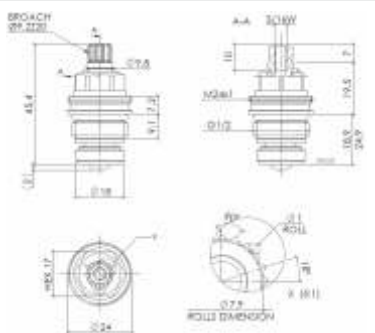

# A12 - VITONI DI RICAMBIO PER RUBINETTI



## VITONE 1/2 BROCCIA Ø 10x20 MILLERIGHI

CODICE	DESCRIZIONE	RIF. F.	CF	M.V.	PREZZO
00943 0000	Mamoli	VDS12004NB043	1	1	€ 9,30

- Q:21,5

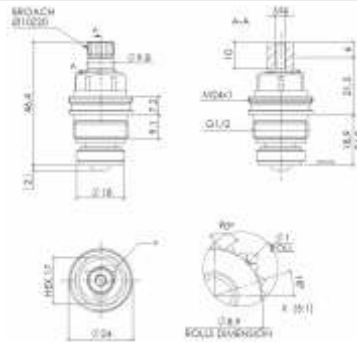

## VITONE 1/2 BROCCIA Ø 7,8x18 MILLERIGHI

CODICE	DESCRIZIONE	RIF. F.	CF	M.V.	PREZZO
00944 0000	Zucchetti	VSS12004NB034S01	1	1	€ 11,20

- Q:18,9

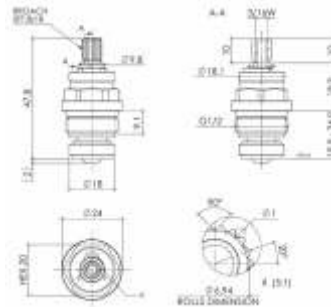

## VITONE 1/2 C/BROCCIA Ø 8x20 MILLERIGHI

CODICE	DESCRIZIONE	RIF. F.	CF	M.V.	PREZZO
00931 0000	Asta lunga	VDS12-004NB-031	10	1	€ 9,50

- Q:35

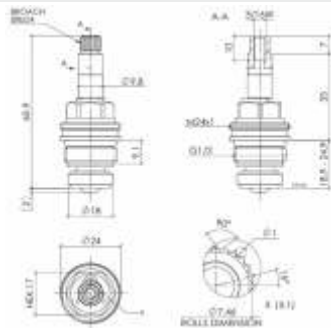

## VITONE CERAMICO 1/2 Ø 7,5x20 MILLERIGHI

CODICE	DESCRIZIONE	RIF. F.	CF	M.V.	PREZZO
00949 0001	DX - acqua fredda	VCA12-090DA-024	10	1	€ 10,20
00949 0002	SX - acqua calda	VCA12-090SA-024	10	1	€ 10,20

- Q:20

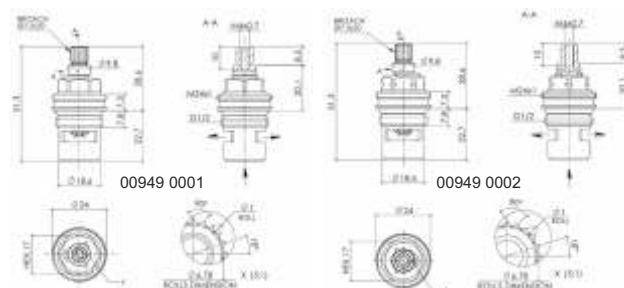

# A12 - VITONI DI RICAMBIO PER RUBINETTI

## VITONE CERAMICO 1/2 Ø 7,8x20 MILLERIGHI

CODICE	DESCRIZIONE	RIF. F.	CF	M.V.	PREZZO
00946 0001	DX - acqua fredda	VDA12-090DA-44	10	1	€ 9,90
00946 0002	SX - acqua calda	VDA12-090SA-44	10	1	€ 9,90

- Q:29,5

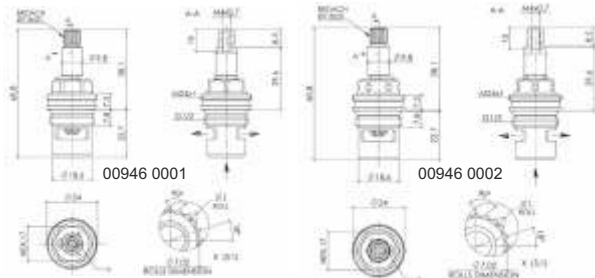

## VITONE CERAMICO 1/2 Ø 9x18 MILLERIGHI CANTU'

CODICE	DESCRIZIONE	RIF. F.	CF	M.V.	PREZZO
00948 0001	DX - acqua fredda	VCA12-090DA-122S01	10	1	€ 15,75
00948 0002	SX - acqua calda	VCA12-090SA-122S01	10	1	€ 15,75

- Cantù  
- Q:43  
- 24x19;  
21x19

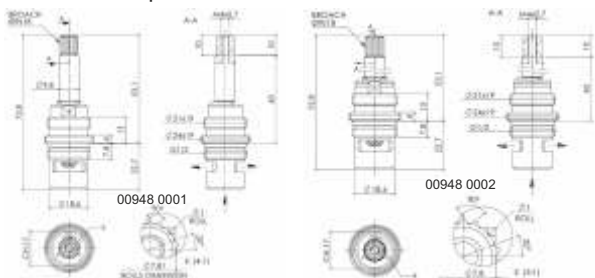

## VITONE CERAMICO 1/2 Ø 7,8x18 MILLERIGHI

CODICE	DESCRIZIONE	RIF. F.	CF	M.V.	PREZZO
00928 0001	DX - acqua fredda	VCA12-090DA-155	10	1	€ 10,20
00928 0002	SX - acqua calda	VCA12-090SA-155	10	1	€ 10,20

- Q:19,5

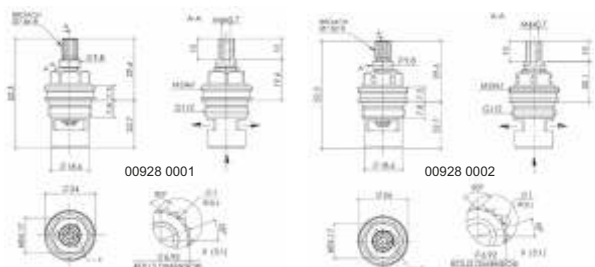

## VITONE CERAMICO 1/2 Ø 8x24 MILLERIGHI

CODICE	DESCRIZIONE	RIF. F.	CF	M.V.	PREZZO
00929 0001	DX - acqua fredda	VCA12-090DA-027S01	5	1	€ 13,70
00929 0002	SX - acqua calda	VCA12-090SA-027S01	5	1	€ 13,70

- Q:45  
- 24x19;  
19x19

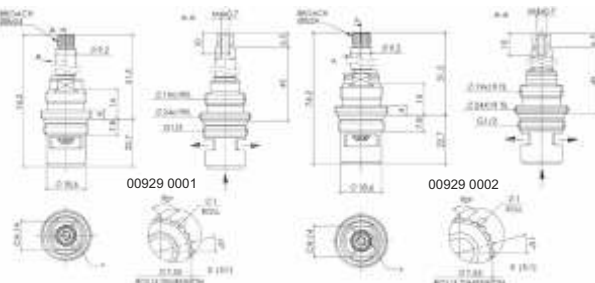

# CASSETTE WC



# RICAMBI PER CASSETTE WC



# SISTEMI DI RISCIACCO



# PASSI RAPIDI



# VITONI PER RUBINETTI



Rubinetterie Matella Giovanni  
*evolution*



## ELEMENTI BAGNO

E

## ACCESSORI

*Un sorriso non costa nulla.  
Arricchisce chi lo riceve,  
senza impoverire chi lo dona.  
Non dura che un istante,  
ma il suo ricordo può durare per sempre.*

*P. Faber*

**Roca**

**CR**<sup>®</sup>

**JMC**  
ARREDO BAGNO

**Laneri**  
sanitary ware

**GIÀVA**

**METAFORM**<sup>®</sup>

**fischer**

**DAMAST**

**RUSSO TERMIDRAULICA**



Laneri  
sanitary ware

# ELEMENTI BAGNO



# ACCESSORI



Roca



DAMAST



GIAVA

METAFORM®

fischer

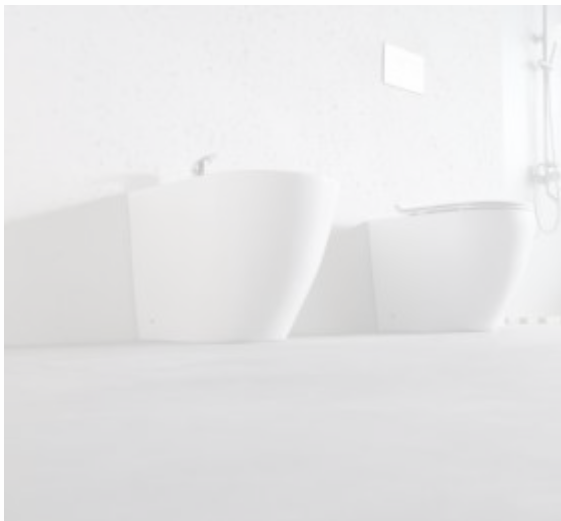

# ELEMENTI BAGNO

 DAMAST

**Laneri**  
sanitary ware

 JMC  
ARREDO BAGNO

**Roca**



# ACCESSORI



GIAVA

 METAFORM®

**fischer** 



GIAVA



## LAVABO E COLONNA CRISTINA

CODICE	DESCRIZIONE	CF	M.V.	PREZZO
01000 6500	Lavabo cm 63	1	1	€ 65,63
01000 5000	Lavabo cm 50	1	1	€ 65,63
01002 0000	Colonna	1	1	€ 50,28



## WC CRISTINA

CODICE	DESCRIZIONE	CF	M.V.	PREZZO
01004 0000	Scarico terra	1	1	€ 79,91

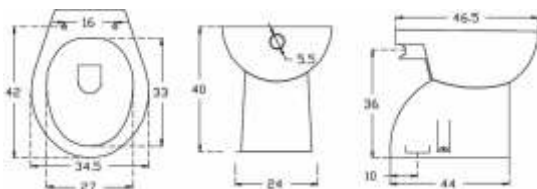

## WC SCARICO PARETE CRISTINA

CODICE	DESCRIZIONE	CF	M.V.	PREZZO
01006 0000	Scarico parete	1	1	€ 79,91



## BIDET CRISTINA

CODICE	DESCRIZIONE	CF	M.V.	PREZZO
01008 0000	Monoforo	1	1	€ 79,91

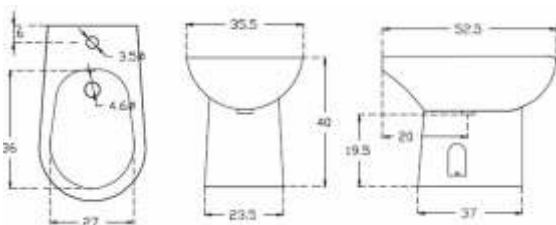

# B1 - ELEMENTI BAGNO CLARA



**Roca**

## LAVABO CLARA

CODICE	DESCRIZIONE	CF	M.V.	PREZZO
01010 5700	Lavabo cm 57	1	1	€ 78,67
01010 6800	Lavabo cm 68	1	1	€ 80,46
01012 0000	Colonna	1	1	€ 55,31



**Roca**

## WC FILO MURO CLARA

CODICE	DESCRIZIONE	CF	M.V.	PREZZO
01016 0000	Scarico universale	1	1	€ 162,50



**Roca**

## BIDET A TERRA FILO MURO CLARA

CODICE	DESCRIZIONE	CF	M.V.	PREZZO
01018 0000	--	1	1	€ 162,50



**Roca**

## SEDILE WC CLARA

CODICE	DESCRIZIONE	CF	M.V.	PREZZO
01017 0000	--	1	1	€ 60,70



## WC FILO MURO MOON

CODICE	DESCRIZIONE	CF	M.V.	PREZZO
01020 0000	A terra	1	1	€ 329,00

- Coprivaso in termoindurente soft close incluso.
- Fissaggi a terra e curva tecnica inclusi.
- Senza brida.

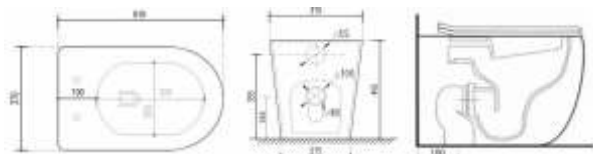

**Laneri**  
sanitary ware

## BIDET FILO MURO MOON

CODICE	DESCRIZIONE	CF	M.V.	PREZZO
01021 0000	A terra	1	1	€ 247,00

- Fissaggi a terra inclusi.



**Laneri**  
sanitary ware

## WC FILO MURO EDGE SQUADRATO

CODICE	DESCRIZIONE	CF	M.V.	PREZZO
01023 0000	A terra	1	1	€ 342,00

- Coprivaso in termoindurente soft close incluso.
- Fissaggi a terra e curva tecnica inclusi.
- Senza brida.

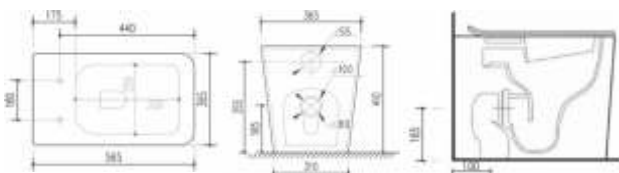

**Laneri**  
sanitary ware

## BIDET FILO MURO EDGE SQUADRATO

CODICE	DESCRIZIONE	CF	M.V.	PREZZO
01024 0000	A terra	1	1	€ 260,00

- Fissaggi a terra inclusi.

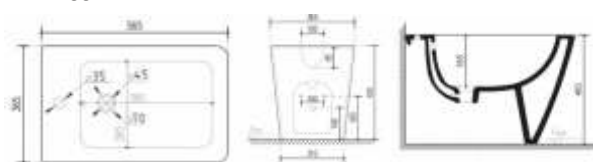

**Laneri**  
sanitary ware

# B1 - ELEMENTI BAGNO FILO MURO



**Laneri**  
sanitary ware

## WC FILO MURO NEW BENT

CODICE	DESCRIZIONE	CF	M.V.	PREZZO
01026 0000	A terra	1	1	€ 342,00

- Coprivaso in termoidurente soft close incluso.
- Fissaggi a terra e curva tecnica inclusi.
- Senza brida.

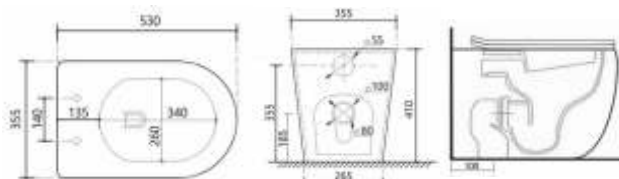

**Laneri**  
sanitary ware

## BIDET FILO MURO NEW BENT

CODICE	DESCRIZIONE	CF	M.V.	PREZZO
01027 0000	A terra	1	1	€ 260,00

- Fissaggi a terra inclusi.

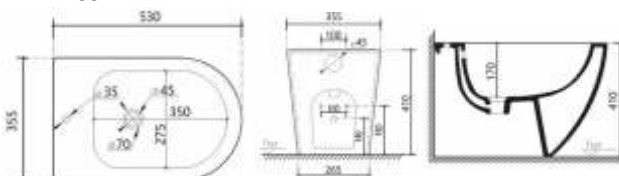

## WC NEW BENT SOSPESO

CODICE	DESCRIZIONE	CF	M.V.	PREZZO
01030 0000	Sospeso	1	1	€ 264,00

- Coprivaso in termoindurente soft close incluso.
- Fissaggi inclusi.
- Senza brida.

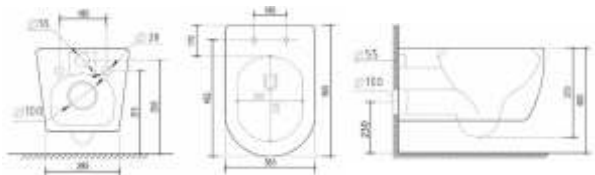

**Laneri**  
sanitary ware

## BIDET NEW BENT SOSPESO

CODICE	DESCRIZIONE	CF	M.V.	PREZZO
01031 0000	Sospeso	1	1	€ 181,00

- Fissaggi inclusi.

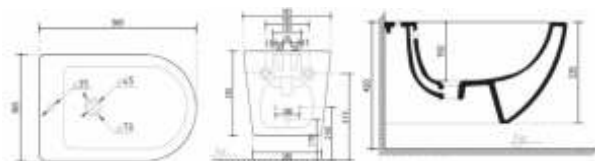

**Laneri**  
sanitary ware

## WC NEW EDGE SQUADRATO SOSPESO

CODICE	DESCRIZIONE	CF	M.V.	PREZZO
01033 0000	Sospeso	1	1	€ 264,00

- Coprivaso in termoindurente soft close incluso.
- Fissaggi inclusi.
- Senza brida.

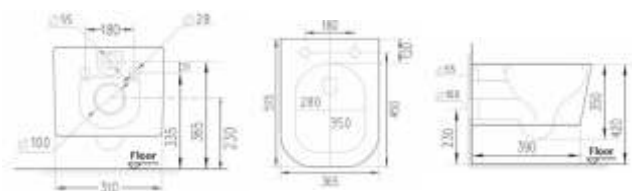

**Laneri**  
sanitary ware

## BIDET NEW EDGE SQUADRATO SOSPESO

CODICE	DESCRIZIONE	CF	M.V.	PREZZO
01034 0000	Sospeso	1	1	€ 181,00

- Fissaggi inclusi.

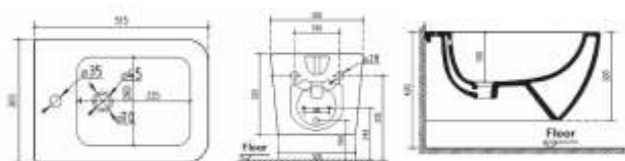

**Laneri**  
sanitary ware

## B2 - ELEMENTI BAGNO TERZA ETÀ'



### WC TERZA ETÀ'

CODICE	DESCRIZIONE	CF	M.V.	PREZZO
01104 0000	Scarico a terra	1	1	€ 197,22



### BIDET TERZA ETÀ'

CODICE	DESCRIZIONE	CF	M.V.	PREZZO
01108 0000	-	1	1	€ 197,22



### SEDILE PER VASO TERZA ETÀ'

CODICE	DESCRIZIONE	CF	M.V.	PREZZO
01109 0000	-	1	1	€ 129,50



## LAVABO PER DISABILE

CODICE	DESCRIZIONE	CF	M.V.	PREZZO
01110 0000	cm 65	1	1	€ 197,20

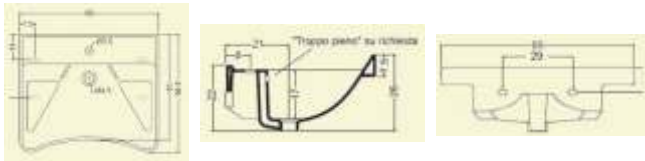

## VASO PER DISABILE

CODICE	DESCRIZIONE	CF	M.V.	PREZZO
01114 0000	Scarico terra	1	1	€ 197,20

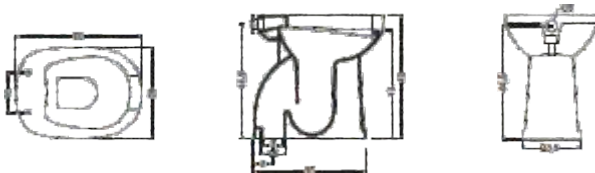

## VASO PER DISABILE

CODICE	DESCRIZIONE	CF	M.V.	PREZZO
01116 0000	Scarico parete	1	1	€ 197,20

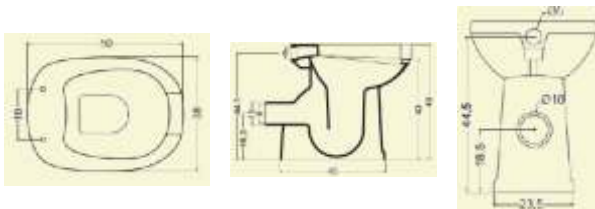

## SEBILE PER VASO DISABILE APERTO

CODICE	DESCRIZIONE	CF	M.V.	PREZZO
01119 0000	Aperto	3	1	€ 47,50



## B3 - ELEMENTI BAGNO DISABILI



### STAFFA PER LAVABO DISABILE

CODICE	DESCRIZIONE	CF	M.V.	PREZZO
01120 0000	570x355/155	1	1	€ 58,25

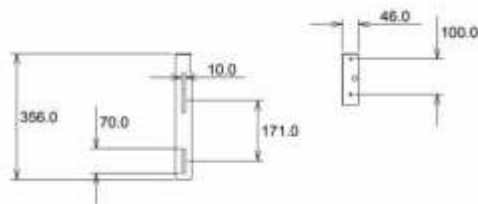

### MECCANISMO PNEUMATICO PER LAVABO DISABILE

CODICE	DESCRIZIONE	CF	M.V.	PREZZO
01122 0000	Meccanismo pneumatico lavabo	1	1	€ 302,00



### SPECCHIO RECLINABILE

CODICE	DESCRIZIONE	CF	M.V.	PREZZO
01126 0000	65 x 50	1	1	€ 278,00



## CORRIMANO LINEARE PLASTICA BIANCO

CODICE	DESCRIZIONE	CF	M.V.	PREZZO
01130 3000	cm 30	6	1	€ 18,15
01130 4500	cm 45	6	1	€ 20,61
01130 6000	cm 60	6	1	€ 24,23



## CORRIMANO LINEARE PREVERNICIATO BIANCO

CODICE	DESCRIZIONE	CF	M.V.	PREZZO
01132 3500	cm 35	1	1	€ 37,60
01132 4500	cm 45	1	1	€ 44,47
01132 6000	cm 60	1	1	€ 51,86
01132 8000	cm 80	1	1	€ 95,94

- Acciaio verniciato bianco.



## MANIGLIONE RIBALTABILE

CODICE	DESCRIZIONE	CF	M.V.	PREZZO
01124 0000	cm 60	1	1	€ 172,00



## MANIGLIONE RIBALTABILE C/PORTA CARTA IGIENICA

CODICE	DESCRIZIONE	CF	M.V.	PREZZO
01125 0000	cm 80	1	1	€ 196,00

- Bianco





## LAVATOIO PVC CON SPORTELLO RUGIADA

CODICE	DESCRIZIONE	CF	M.V.	PREZZO
01140 4550	45x50 H85	1	1	€ 192,50
01140 5050	50x50 H85	1	1	€ 195,00

- Vasca forabile per installazione rubinetto.
- Asse in materiale plastico.
- Incluso sifone con attacco lavatrice e piletta.
- Piedini regolabili in altezza mm 15.



## LAVATOIO PVC CON SPORTELLI RUGIADA

CODICE	DESCRIZIONE	CF	M.V.	PREZZO
01142 6050	60x50 H85	1	1	€ 200,00
01142 6060	60x60 H85	1	1	€ 220,40

- Vasca forabile per installazione rubinetto.
- Asse in materiale plastico.
- Incluso sifone con attacco lavatrice e piletta.
- Piedini regolabili in altezza mm 15.



## LAVATOIO IN LEGNO CON PILOZZA MINI IN PVC

CODICE	DESCRIZIONE	CF	M.V.	PREZZO
01144 3543	34,5x42,5xH78	1	1	€ 180,00

- Mobile: legno bilaminato.
- Pomello: satinato.
- Vasca: materiale plastico resistente agli acidi, forabile per installazione rubinetto.
- Completo di sifone e piletta.
- Piedini: regolabili in altezza, 15 mm.



## LAVATOIO IN LEGNO CON PILOZZA IN PVC BIANCO

CODICE	DESCRIZIONE	CF	M.V.	PREZZO
01145 4550	45x50xH85	1	1	€ 219,00
01145 5050	50x50xH85	1	1	€ 221,50
01145 6050	60x50xH85	1	1	€ 235,20



## LAVATOIO IN LEGNO OLMO

CODICE	DESCRIZIONE	CF	M.V.	PREZZO
01146 4550	45x50	1	1	€ 260,00
01146 6050	60x50	1	1	€ 260,00



## PILOZZA PVC MINI

CODICE	DESCRIZIONE	CF	M.V.	PREZZO
01148 0050	50x34xH21	1	1	€ 44,90

- Capacità 13,5 lt.
- Ripiano portasapone, predisposto per foro rubinetto.
- Kit di fissaggio a parete incluso.
- Completo di sifone e piletta.



## TOELETTE BAGNO SIMPATY

CODICE	DESCRIZIONE	CF	M.V.	PREZZO
01480 0000	58x37x12 cm	1	1	€ 52,50

- Predisposizione luce ed interruttore.





## PORTA SAPONE ZERO CROMO

CODICE	DESCRIZIONE	CF	M.V.	PREZZO
01550 0000	cromo	6	1	€ 15,85

- Fissaggio a vite.
- Garanzia 5 anni.
- Materiale termoplastico - Leghe metalliche.
- Fornito in blister da appendere.



## PORTA SPAZZOLINO ZERO CROMO

CODICE	DESCRIZIONE	CF	M.V.	PREZZO
01551 0000	cromo	6	1	€ 15,85

- Fissaggio a vite.
- Garanzia 5 anni.
- Materiale termoplastico - Leghe metalliche.
- Fornito in blister da appendere.



## PORTA ROTOLO ZERO CROMO

CODICE	DESCRIZIONE	CF	M.V.	PREZZO
01552 0000	cromo	6	1	€ 20,50

- Fissaggio a vite.
- Garanzia 5 anni.
- Materiale termoplastico - Leghe metalliche.
- Fornito in blister da appendere.



## PORTA ACCAPPATOIO ZERO CROMO

CODICE	DESCRIZIONE	CF	M.V.	PREZZO
01553 0000	cromo - pz. 2	6	1	€ 20,50*

- Fissaggio a vite.
- Garanzia 5 anni.
- Materiale termoplastico - Leghe metalliche.
- Fornito in blister da appendere.

\* Prezzo riferito alla coppia



## PORTA ASCIUGAMANI CM 30 ZERO CROMO

CODICE	DESCRIZIONE	CF	M.V.	PREZZO
01554 0000	cromo cm 30	6	1	€ 25,75

- Fissaggio a vite.
- Garanzia 5 anni.
- Materiale termoplastico - Leghe metalliche.
- Fornito in blister da appendere.



## PORTA ASCIUGAMANI CM 45 ZERO CROMO

CODICE	DESCRIZIONE	CF	M.V.	PREZZO
01555 0000	cromo cm 45	6	1	€ 27,80

- Fissaggio a vite.
- Garanzia 5 anni.
- Materiale termoplastico - Leghe metalliche.
- Fornito in blister da appendere.



## SET 5 ACCESSORI ZERO CROMO

CODICE	DESCRIZIONE	CF	M.V.	PREZZO
01559 0000	cromo	1	1	€ 61,50

- Composto da: portaspazzolino, porta asciugamani cm 30, porta asciugamani cm 45, coppia appendi abiti, porta rotolo aperto.
- Materiale: leghe metalliche e ABS.
- Garanzia 5 anni.



## PORTA SCOPINO PLASTICA MOD. LUSSO

CODICE	DESCRIZIONE	CF	M.V.	PREZZO
01558 0000	bianco	16	1	€ 6,75





## PORTA SAPONE STARTER

CODICE	DESCRIZIONE	CF	M.V.	PREZZO
01560 0000	--	4	1	€ 16,90

- Fissaggio a vite oppure adesivo.
- Garanzia 5 anni.
- Materiale acciaio inox e vetro.
- Fornito in blister appendibile.



## PORTA SPAZZOLINO STARTER

CODICE	DESCRIZIONE	CF	M.V.	PREZZO
01561 0000	--	4	1	€ 16,90

- Fissaggio a vite oppure adesivo.
- Garanzia 5 anni.
- Materiale acciaio inox e vetro.
- Fornito in blister appendibile.



## PORTA ROTOLO STARTER

CODICE	DESCRIZIONE	CF	M.V.	PREZZO
01562 0000	--	4	1	€ 21,20

- Fissaggio a vite oppure adesivo.
- Garanzia 5 anni.
- Materiale acciaio inox e vetro.
- Fornito in blister appendibile.



## PORTA ACCAPPATOIO STARTER

CODICE	DESCRIZIONE	CF	M.V.	PREZZO
01563 0000	--	4	1	€ 16,40

- Fissaggio a vite oppure adesivo.
- Garanzia 5 anni.
- Materiale acciaio inox e vetro.
- Fornito in blister appendibile.



## PORTA ASCIUGAMANI CM 30 STARTER

CODICE	DESCRIZIONE	CF	M.V.	PREZZO
01564 0000	30 cm	4	1	€ 28,00

- Fissaggio a vite oppure adesivo.
- Garanzia 5 anni.
- Materiale acciaio inox e vetro.
- Fornito in blister appendibile.



## PORTA ASCIUGAMANI CM45 STARTER

CODICE	DESCRIZIONE	CF	M.V.	PREZZO
01565 0000	45 cm	4	1	€ 29,90

- Fissaggio a vite oppure adesivo.
- Garanzia 5 anni.
- Materiale acciaio inox e vetro.
- Fornito in blister appendibile.



## PORTA SCOPINO STARTER

CODICE	DESCRIZIONE	CF	M.V.	PREZZO
01568 0000	--	1	1	€ 18,75

- Garanzia 5 anni.





## SEDILE WC LACCATO LEGNO

CODICE	DESCRIZIONE	CF	M.V.	PREZZO
01210 0000	Bianco	5	1	€ 31,20



## SEDILE WC MDF SINTESI

CODICE	DESCRIZIONE	CF	M.V.	PREZZO
01212 0000	Bianco	3	1	€ 41,25



## SEDILE WC MDF ARETUSA

CODICE	DESCRIZIONE	CF	M.V.	PREZZO
01214 0000	Bianco	3	1	€ 42,25



## SEDILE WC MDF CONCA

CODICE	DESCRIZIONE	CF	M.V.	PREZZO
01218 0000	Bianco	3	1	€ 42,25

X → 35  
Y → 45  
Z → 16

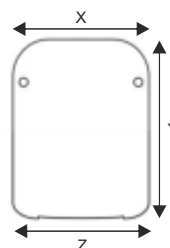

## SEDILE WC PLASTICA LEGGERA

CODICE	DESCRIZIONE	CF	M.V.	PREZZO
01200 0000	Chiusura normale	1	1	€ 14,00



## SEDILE WC K2

CODICE	DESCRIZIONE	CF	M.V.	PREZZO
01202 0000	Bianco	9	1	€ 21,25



## SEDILE WC K2

CODICE	DESCRIZIONE	CF	M.V.	PREZZO
01204 0000	Champagne	1	1	€ 23,60



## SEDILE WC TERMOINDURENTE KOMODO

CODICE	DESCRIZIONE	CF	M.V.	PREZZO
01205 0000	Bianco	6	1	€ 43,75

- Cerniere INOX regolabili
- Universale
- Peso 1,980 kg





## SEDILE WC TERMOINDURENTE UNIVERSO CERNIERE PLASTICA

CODICE	DESCRIZIONE	CF	M.V.	PREZZO
01220 0100	Universo Forma 1	5	1	€ 32,00

X → 37  
Y → 45  
Z → 15

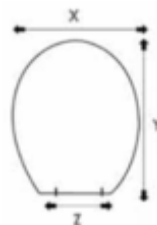

## SEDILE WC TERMOINDURENTE UNIVERSO CERNIERE INOX

CODICE	DESCRIZIONE	CF	M.V.	PREZZO
01222 0100	Universo Forma 1	5	1	€ 36,00

X → 37  
Y → 45  
Z → 15

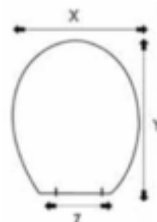

**New**

## SEDULE WC TERMOINDURENTE SOFT CLOSE

CODICE	DESCRIZIONE	CF	M.V.	PREZZO
01221 0000	Universale	7	1	€ 42,25

- Cerniere INOX
- Sgancio rapido dal vaso
- Kg 1,450



## SEDILE WC TERMOINDURENTE KARLA

CODICE	DESCRIZIONE	CF	M.V.	PREZZO
01223 0000	cerniere inox	5	1	€ 33,90



## SEDILE WC TERMOINDURENTE SINTESI

CODICE	DESCRIZIONE	CF	M.V.	PREZZO
01224 0600	Forma 6	5	1	€ 65,50

X → 35  
Y → 44,5  
Z → 18

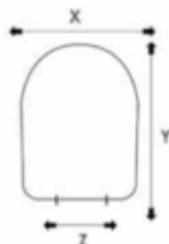

## SEDILE WC TERMOINDURENTE FORMA 6

CODICE	DESCRIZIONE	CF	M.V.	PREZZO
01226 0600	Forma 6	5	1	€ 65,50

X → 35  
Y → 44,5  
Z → 18

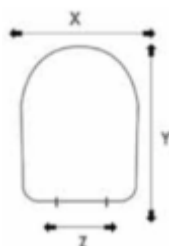

## SEDILE WC TERMOINDURENTE ARETUSA

CODICE	DESCRIZIONE	CF	M.V.	PREZZO
01228 0300	Forma 3	5	1	€ 65,50

X → 37  
Y → 45,5  
Z → 18

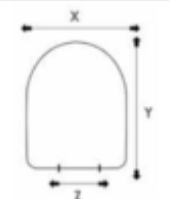



## SEDILE WC TERMOINDURENTE COMETA

CODICE	DESCRIZIONE	CF	M.V.	PREZZO
01230 0200	Forma 2	5	1	€ 65,50

X → 37  
Y → 42,5  
Z → 18

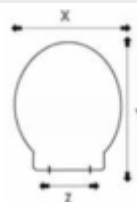

## SEDILE WC TERMOINDURENTE POLO

CODICE	DESCRIZIONE	CF	M.V.	PREZZO
01232 1800	Forma 18	5	1	€ 55,00

X → 36,5  
Y → 40  
Z → 13

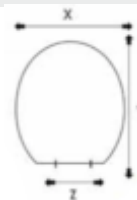

## SEDILE WC TERMOINDURENTE PER FILO MURO

CODICE	DESCRIZIONE	CF	M.V.	PREZZO
01234 0400	Forma 4	5	1	€ 67,90

X → 37  
Y → 45  
Z → 18

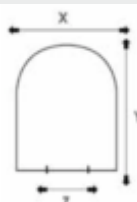

## SEDILE WC TERMOINDURENTE SOFT CLOSE - MINI GIOVE

CODICE	DESCRIZIONE	CF	M.V.	PREZZO
01236 1100	Forma 17	5	1	€ 102,50

X → 36  
Y → 42  
Z → 17,5

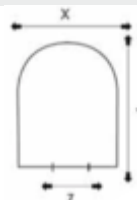

## CERNIERE PLASTICA PER SEDILI WC

CODICE	DESCRIZIONE	CF	M.V.	PREZZO
01250 0000	ABS	25	1	€ 1,37



## CERNIERE UNIVERSALI PER SEDILI WC

CODICE	DESCRIZIONE	CF	M.V.	PREZZO
01252 0000	Cromata	10	1	€ 8,37



## CERNIERE UNIVERSALI PER SEDILE WC AD ESPANSIONE

CODICE	DESCRIZIONE	CF	M.V.	PREZZO
01253 0000	Cromata	1	1	€ 17,10

- Con fissaggio ad espansione.





## CERNIERE INOX PER SEDILE WC TERMOINDURENTE

CODICE	DESCRIZIONE	CF	M.V.	PREZZO
01254 0000	Mod. Revival	1	1	€ 17,50



## CERNIERE INOX PER SEDILE WC TERMOINDURENTE

CODICE	DESCRIZIONE	CF	M.V.	PREZZO
01256 0000	Mod. Goccia	1	1	€ 23,00

- Permette una regolazione maggiore fino a 3,5 cm.



## CERNIERE INOX PER SEDILE WC TERMOINDURENTE STACCABILE

CODICE	DESCRIZIONE	CF	M.V.	PREZZO
01258 0000	Mod. Horizont	1	1	€ 20,80



## KIT FISSAGGIO SANITARI SOSPESI

CODICE	DESCRIZIONE	CF	M.V.	PREZZO
01317 0001	--	2	2	€ 14,70

- Corpo in spugna nero con sede in metallo con perni e tappi.



## KIT FISSAGGIO SANITARI SOSPESI

CODICE	DESCRIZIONE	CF	M.V.	PREZZO
01317 0002	--	2	2	€ 14,70

- Corpo in spugna nero con sede in metallo con perni e tappi.



## SET DI FISSAGGIO PER CERNIERE SEDILE WC

CODICE	DESCRIZIONE	CF	M.V.	PREZZO
01240 0000	Con farfalla	10	1	€ 2,50



## SET DI FISSAGGIO PER CERNIERE SEDILE WC

CODICE	DESCRIZIONE	CF	M.V.	PREZZO
01242 0000	Ad espansione	10	1	€ 3,00



## B7 - FISSAGGI SANITARI



### ELEMENTO DI FISSAGGIO PER LAVABO

CODICE	DESCRIZIONE	CF	M.V.	PREZZO
01302 0000	10 x 120	50	1	€ 1,80



### ELEMENTO DI FISSAGGIO PER VASI E BIDET

CODICE	DESCRIZIONE	CF	M.V.	PREZZO
01304 0000	90 mm - 4 pz	50	1	€ 2,48



**New**

### ELEMENTO DI FISSAGGIO PER VASI CON DADO INOX

CODICE	DESCRIZIONE	CF	M.V.	PREZZO
01305 0000	100 mm - 2 pz	10	1	€ 4,50

- 2 tasselli diametro 10 mm
- 2 dadi INOX
- 2 bussole in nylon
- 2 viti doppio filetto in acciaio M5 x 80



### ELEMENTI DI FISSAGGIO LATERALE PER SANITARI

CODICE	DESCRIZIONE	CF	M.V.	PREZZO
01306 0000	Zanche antiurto	50	1	€ 3,81

## ELEMENTO DI FISSAGGIO PER CALDAIE E SCALDABAGNI

CODICE	DESCRIZIONE	CF	M.V.	PREZZO
01308 0000	10 x 95	50	1	€ 1,87



## ELEMENTO DI FISSAGGIO SCALDABAGNI PER MATTONI FORATI

CODICE	DESCRIZIONE	CF	M.V.	PREZZO
01309 0000	--	50	1	€ 4,58



## ELEMENTO DI FISSAGGIO PER CALDAIE E SCALDABAGNI

CODICE	DESCRIZIONE	CF	M.V.	PREZZO
01318 0000	WBS 12 X	50	1	€ 5,20



## ELEMENTO DI FISSAGGIO PER CALDAIE E SCALDABAGNI

CODICE	DESCRIZIONE	CF	M.V.	PREZZO
01319 0000	PFS 12 (anche per forati)	50	1	€ 6,22



## B7 - FISSAGGI SANITARI



### ELEMENTO DI FISSAGGIO PER LAVABO

CODICE	DESCRIZIONE	CF	M.V.	PREZZO
01312 0000	WST 120	50	1	€ 5,35



### ELEMENTO DI FISSAGGIO PER VASI E BIDET

CODICE	DESCRIZIONE	CF	M.V.	PREZZO
01314 0000	WB 2 pz 4	25	1	€ 6,40



### ELEMENTO DI FISSAGGIO LATERALE PER SANITARI

CODICE	DESCRIZIONE	CF	M.V.	PREZZO
01316 0000	WB 5 N	50	1	€ 11,00

## PIATTO DOCCIA BIANCO ARDESIA EFFETTO PIETRA H 3 CM

CODICE	DESCRIZIONE	CF	M.V.	PREZZO
01512 7090	70x90	1	1	€ 261,10
01512 7010	70x100	1	1	€ 277,80
01512 7012	70x120	1	1	€ 294,50
01512 7014	70x140	1	1	€ 347,20
01512 7016	70x160	1	1	€ 409,50
01512 7018	70x180	1	1	€ 438,60
01512 7020	70x200	1	1	€ 482,50
01512 8080	80x80	1	1	€ 261,10
01512 8010	80x100	1	1	€ 283,30
01512 8012	80x120	1	1	€ 330,55
01512 8014	80x140	1	1	€ 372,20
01512 8016	80x160	1	1	€ 453,20
01512 8018	80x180	1	1	€ 497,00
01512 8020	80x200	1	1	€ 526,30
01512 9090	90x90	1	1	€ 333,50
01512 9010	90x100	1	1	€ 392,00
01512 9012	90x120	1	1	€ 412,50
01512 9014	90x140	1	1	€ 469,00
01512 9016	90x160	1	1	€ 506,00
01512 9018	90x180	1	1	€ 675,00
01512 9020	90x200	1	1	€ 712,00
01512 1010	100x100	1	1	€ 399,00
01512 1012	100x120	1	1	€ 421,00
01512 1014	100x140	1	1	€ 506,00
01512 1016	100x160	1	1	€ 656,00
01512 1018	100x180	1	1	€ 731,00
01512 1020	100x200	1	1	€ 806,00

- Griglia inox inclusa.

- Piletta da ordinare a parte cod. 03046 0000.

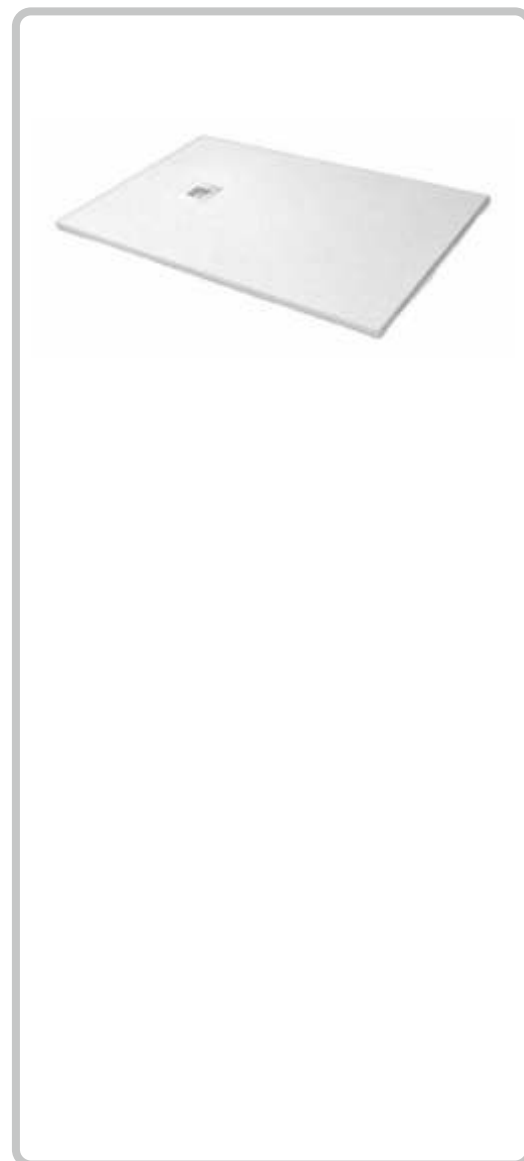

## PIATTO DOCCIA GRIGIO CHIARO ARDESIA EFFETTO PIETRA H 3 CM

CODICE	DESCRIZIONE	CF	M.V.	PREZZO
01514 7090	70x90	1	1	€ 274,15
01514 7010	70x100	1	1	€ 291,70
01514 7012	70x120 *	1	1	€ 309,20
01514 7014	70x140	1	1	€ 364,50
01514 7016	70x160	1	1	€ 430,00
01514 7018	70x180	1	1	€ 460,50
01514 7020	70x200	1	1	€ 506,50
01514 8080	80x80	1	1	€ 274,15
01514 8010	80x100	1	1	€ 297,50
01514 8012	80x120 *	1	1	€ 347,00
01514 8014	80x140	1	1	€ 390,80
01514 8016	80x160	1	1	€ 475,90
01514 8018	80x180	1	1	€ 521,90
01514 8020	80x200	1	1	€ 552,60

- Griglia inox inclusa.

- Piletta da ordinare a parte cod. 03046 0000.

\* Articoli in pronta consegna.



## B8 - PIATTI DOCCIA ARDESIA



### PIATTO DOCCIA TORTORA ARDESIA EFFETTO PIETRA H 3 CM

CODICE	DESCRIZIONE	CF	M.V.	PREZZO
01513 7090	70x90	1	1	€ 274,15
01513 7010	70x100	1	1	€ 291,70
01513 7012	70x120 *	1	1	€ 309,20
01513 7014	70x140	1	1	€ 364,50
01513 7016	70x160	1	1	€ 430,00
01513 7018	70x180	1	1	€ 460,50
01513 7020	70x200	1	1	€ 506,50
01513 8080	80x80	1	1	€ 274,15
01513 8010	80x100	1	1	€ 297,50
01513 8012	80x120 *	1	1	€ 347,00
01513 8014	80x140	1	1	€ 390,80
01513 8016	80x160	1	1	€ 475,90
01513 8018	80x180	1	1	€ 521,90
01513 8020	80x200	1	1	€ 552,60

- Griglia inox inclusa.

- Piletta da ordinare a parte cod. 03046 0000.

\* Articoli in pronta consegna.



**New**

### ANTICALCARE FLAT PLATE

CODICE	DESCRIZIONE	CF	M.V.	PREZZO
01518 0000	ML 750	12	1	€ 34,80

- Specifico per piatti doccia e box doccia.

- Non esala vapori.

- Non danneggia le cromature, né le stuccature.



**New**

### GRIGLIA INOX PER PIATTO DOCCIA

CODICE	DESCRIZIONE	CF	M.V.	PREZZO
01517 0000	12,7 x 12,7	1	1	€ 7,50

## PORTA A SOFFIETTO H 185 MOD. LUX

CODICE	DESCRIZIONE	CF	M.V.	PREZZO
01429 0090	80 ÷ 90 cm	1	1	€ 123,42
01429 0120	110 ÷ 120 cm	1	1	€ 157,00
01429 0140	130 ÷ 140 cm	1	1	€ 183,30

- In PVC rigido estruso color bianco.
- Altezza 185 cm.



## BOX DOCCIA ANGOLARE 2 LATI A SOFFIETTO MOD. LUX

CODICE	DESCRIZIONE	CF	M.V.	PREZZO
01430 8080	70 ÷ 80 x 70 ÷ 80	1	1	€ 173,54
01430 7090	60 ÷ 70 x 80 ÷ 90	1	1	€ 173,54
01430 7010	70 ÷ 80 x 90 ÷ 100	1	1	€ 195,39
01430 7012	70 ÷ 80 x 110 ÷ 120	1	1	€ 219,67

- In PVC rigido estruso color bianco.
- Apertura centrale.
- Altezza 185 cm.



## PEDANA DOCCIA IN PP BIANCA

CODICE	DESCRIZIONE	CF	M.V.	PREZZO
01485 0000	580 x 580 H 23 MM	9	1	€ 18,25

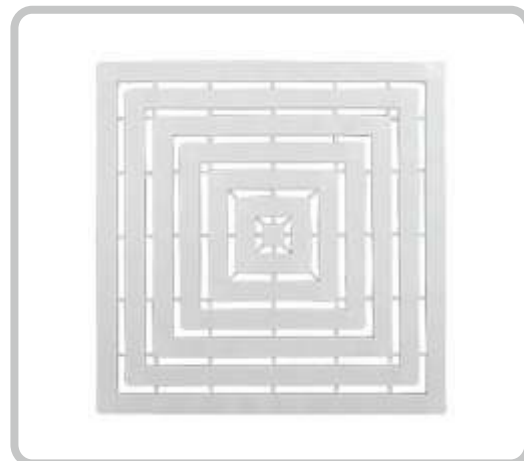



## BOX DOCCIA ANGOLARE SMERALDA 2 LATI REVERSIBILI

CODICE	DESCRIZIONE	CF	M.V.	PREZZO
01421 8080	68 ÷ 80	1	1	€ 330,80
01421 7090	68 ÷ 80 x 79 ÷ 90	1	1	€ 340,00
01421 7010	68 ÷ 80 x 88 ÷ 100	1	1	€ 432,60
01421 7012	68 ÷ 80 x 108 ÷ 120	1	1	€ 464,70

- Apertura scorrevole su pattini in nylon
- Chiusura magnetica
- Profilo in alluminio laccato bianco
- Lastre in acrilico con finitura effetto bollicine
- Abbinabile a lato fisso per formare box 3 lati (attenzione l'articolo aumenta di 1,3 cm)



## LATO FISSO SMERALDA

CODICE	DESCRIZIONE	CF	M.V.	PREZZO
01422 0070	68/72	1	1	€ 207,00
01422 0080	78/82	1	1	€ 227,00

- Profilo in alluminio laccato bianco
- Lastre in acrilico con finitura effetto bollicine
- Abbinabile sia al box 2 lati, sia alla porta



## PORTA AD 1 ANTA SCORREVOLE E 1 FISSA SMERALDA

CODICE	DESCRIZIONE	CF	M.V.	PREZZO
01424 0100	100/105 - apertura 44	1	1	€ 433,00
01424 0120	118/123 - apertura 53	1	1	€ 451,00
01424 0140	136/141 - apertura 56	1	1	€ 476,00

- Apertura scorrevole su pattini in nylon
- Chiusura magnetica
- Profilo in alluminio laccato bianco
- Lastre in acrilico con finitura effetto bollicine
- Abbinabile a lato fisso per formare box 3 lati (attenzione l'articolo aumenta di 1,5 cm)



## PORTA A 2 ANTE A SOFFIETTO SMERALDA

CODICE	DESCRIZIONE	CF	M.V.	PREZZO
01426 0070	68/73 - apertura 58	1	1	€ 430,00
01426 0080	78/83 - apertura 68	1	1	€ 433,00
01426 0090	88/93 - apertura 78	1	1	€ 455,00
01426 0100	98/103 - apertura 88	1	1	€ 455,00

- Apertura scorrevole su cuscinetti a sfera
- Chiusura magnetica
- Profilo in alluminio laccato bianco
- Lastre in acrilico con finitura effetto bollicine
- Abbinabile a lato fisso per formare box 2 o 3 lati (attenzione l'articolo aumenta di 1,5 cm)



## BOX DOCCIA CRISTALLO 6 mm 'PHILADELPHIA'

CODICE	DESCRIZIONE	CF	M.V.	PREZZO
01400 0070	1 lato cm 70	1	1	€ 239,00
01400 0080	1 lato cm 80	1	1	€ 254,00
01400 0090	1 lato cm 90	1	1	€ 273,00
01400 0100	1 lato cm 100	1	1	€ 290,00
01400 0120	1 lato cm 120	1	1	€ 306,00
01400 0140	1 lato cm 140	1	1	€ 339,00

Per formare un box doccia, bisogna prendere due lati.

Esempio: per formare un box 70x90 prendere 01400 0070 + 01400 0090



## PARETE FISSA CRISTALLO 6 mm

CODICE	DESCRIZIONE	CF	M.V.	PREZZO
01402 0070	lato fisso cm 70	1	1	€ 250,00
01402 0080	lato fisso cm 80	1	1	€ 280,00
01402 0090	lato fisso cm 90	1	1	€ 316,00



## PORTA DOCCIA CRISTALLO 6 mm - 2 ante (scorrevole+ fissa) 'RIO'

CODICE	DESCRIZIONE	CF	M.V.	PREZZO
01404 0110	108,5 - 110,5	1	1	€ 580,00
01404 0120	118,5 - 120,5	1	1	€ 598,00
01404 0130	128,5 - 130,5	1	1	€ 615,00
01404 0140	138,5 - 140,5	1	1	€ 652,00



## PORTA DOCCIA CRISTALLO 6 mm - 2 ante - soffietto 'DENVER'

CODICE	DESCRIZIONE	CF	M.V.	PREZZO
01406 0070	67,5 - 70,5	1	1	€ 760,00
01406 0080	77,5 - 80,5	1	1	€ 798,00
01406 0090	87,5 - 90,5	1	1	€ 834,00
01406 0100	97,5 - 100,5	1	1	€ 870,00



**New**



## CANALINA DOCCIA FILO PAVIMENTO

CODICE	DESCRIZIONE	CF	M.V.	PREZZO
01520 0065	cm 65	1	1	€ 278,00
01520 0075	cm 75	1	1	€ 307,00
01520 0095	cm 95	1	1	€ 354,00

- Sifonata in PP grigio con scarico laterale 40/50
- Griglia INOX 304
- H 66 mm



**New**



## CANALINA DOCCIA FILO PAVIMENTO PORTA PIASTRELLA

CODICE	DESCRIZIONE	CF	M.V.	PREZZO
01522 0065	cm 65	1	1	€ 307,00
01522 0075	cm 75	1	1	€ 329,00
01522 0095	cm 95	1	1	€ 362,00

- Sifonata in PP grigio con scarico laterale 40/50
- Griglia INOX 304
- H 66 mm



**New**



## TRITURATORE SANIBASIC

CODICE	DESCRIZIONE	CF	M.V.	PREZZO
07200 0000	H MAX 6 mt. 360 W	1	1	€ 620,00

- Per bagno completo.
- Diametro tubo scarico 22/28/32/40 mm.
- Maceratore con prestazioni elevate di triturazione e pompaggio dotato di cestello-filtro con lama rotante in acciaio INOX e pompa separata.
- Protezione IP68.





# DAMAST



# COLLEZIONE

## DAMAST DOCCETTERIA



## KIT DOCCIA Ø 200 SPAGNA TONDO

CODICE	DESCRIZIONE	RIF. F.	CF	M.V.	PREZZO
01601 0200	Tondo Ø 200	18193	5	1	€ 107,00



## KIT DOCCIA MM 200 SPAGNA QUADRATO

CODICE	DESCRIZIONE	RIF. F.	CF	M.V.	PREZZO
01603 0200	Quadrato 200x200	18194	5	1	€ 126,50



## KIT DOCCIA ROUND DM 250

CODICE	DESCRIZIONE	CF	M.V.	PREZZO
01600 0000	TONDO	10	1	€ 154,10

- Il Kit è composto da:
- Doccetta ottone 1 getto
  - Braccio doccia ottone
  - Soffione doccia acciaio inox Ø 250 mm
  - Supporto doccia in ottone
  - Flessibile doccia PVC grigio



## KIT DOCCIA SQUARE MM 250

CODICE	DESCRIZIONE	CF	M.V.	PREZZO
01602 0000	QUADRATO	10	1	€ 191,10

- Il Kit è composto da:
- Doccetta ottone 1 getto
  - Braccio doccia ottone
  - Soffione doccia acciaio inox 250x250 mm
  - Supporto doccia in ottone
  - Flessibile doccia PVC grigio



## ASTA DOCCIA CROMATO NATURE 125

CODICE	DESCRIZIONE	CF	M.V.	PREZZO
01610 0000	Senza porta sapone	20	1	€ 27,50



## ASTA DOCCETTA REGOLABILE NATURE 106 (EX VENUS)

CODICE	DESCRIZIONE	CF	M.V.	PREZZO
01612 0000		12	1	€ 34,00

- Con asta regolabile, adattabile ai buchi già esistenti.



## ASTA DOCCIA 204 AT

CODICE	DESCRIZIONE	RIF. F.	CF	M.V.	PREZZO
01615 0000	1 getto	15444	1	1	€ 80,00

- Asta inox cromata
- Scorrevole e laterali ABS cromato
- Flessibile cm 150 doppia aggraffatura

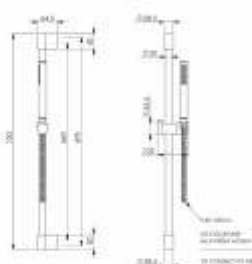

## ASTA DOCCIA SLIM INOX CROMATO

CODICE	DESCRIZIONE	RIF. F.	CF	M.V.	PREZZO
01619 0000	1 getto	17015	1	1	€ 88,00

- Asta inox cromata 40 x 10 mm
- Scorrevole e laterali ABS cromato
- Flessibile cm 150 doppia aggraffatura

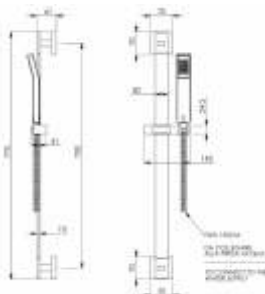



## ASTA DOCCIA TEMPESTA

CODICE	DESCRIZIONE	CF	M.V.	PREZZO
01614 0000	2 Getti	1	1	€ 96,50



## SET COLONNA CON ASTA 200 x 200 IN ACCIAIO

CODICE	DESCRIZIONE	CF	M.V.	PREZZO
01616 0000	200 x 200 - Doccetta 5 getti	12	1	€ 94,80



## DEVIATORE PER COLONNA DOCCIA

CODICE	DESCRIZIONE	CF	M.V.	PREZZO
01609 0000	3/4 x 1/2 x 1/2	1	1	€ 17,30



## MISCELATORE INCASSO C/SUPPORTO INTEGRATO

CODICE	DESCRIZIONE	CF	M.V.	PREZZO
01608 0000	Cromato	1	1	€ 75,00



## CURVETTA DOCCIA CON ROSONE

CODICE	DESCRIZIONE	CF	M.V.	PREZZO
01620 0000	1/2 x 1/2	20	1	€ 3,83



## CURVETTA DOCCIA TONDA

CODICE	DESCRIZIONE	CF	M.V.	PREZZO
01622 0000	1/2 x 1/2	1	1	€ 21,35



## CURVETTA DOCCIA QUADRA

CODICE	DESCRIZIONE	CF	M.V.	PREZZO
01623 0000	1/2 x 1/2	1	1	€ 31,25



## PRESA ACQUA C/SUPPORTO CORDOBA T

CODICE	DESCRIZIONE	RIF. F.	CF	M.V.	PREZZO
01628 0000	1/2	18187	1	1	€ 20,30

- In ottone

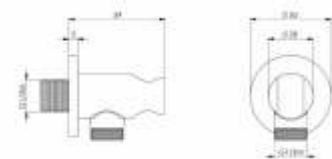

DAMAST

## PRESA ACQUA C/SUPPORTO VALENCIA Q

CODICE	DESCRIZIONE	RIF. F.	CF	M.V.	PREZZO
01629 0000	1/2	18188	1	1	€ 25,50

- In ottone

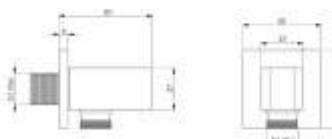

DAMAST



## PRESA ACQUA TONDA NERA

CODICE	DESCRIZIONE	CF	M.V.	PREZZO
01630 0000	mm 1/2	1	1	€ 33,00



## PRESA ACQUA QUADRA NERA

CODICE	DESCRIZIONE	CF	M.V.	PREZZO
01632 0000	mm 1/2	1	1	€ 39,70



## BRACCIO DOCCIA TONDO NERO OPACO

CODICE	DESCRIZIONE	CF	M.V.	PREZZO
01634 0000	cm 30	1	1	€ 55,00



## BRACCIO DOCCIA QUADRATO NERO OPACO

CODICE	DESCRIZIONE	CF	M.V.	PREZZO
01636 0000	cm 30	1	1	€ 55,00



## SOFFIONE DOCCIA TONDO NERO

CODICE	DESCRIZIONE	CF	M.V.	PREZZO
01654 0000	Ø 200	1	1	€ 56,50

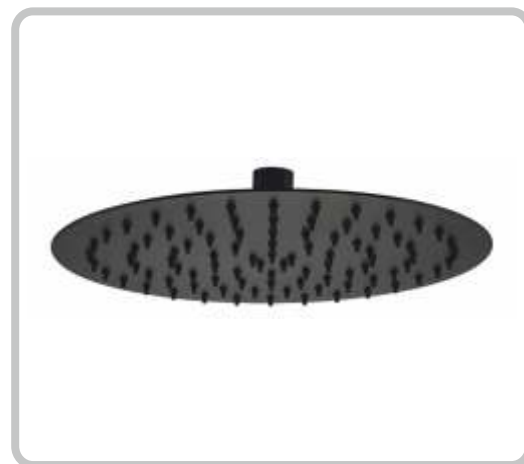

## SOFFIONE DOCCIA QUADRO NERO

CODICE	DESCRIZIONE	CF	M.V.	PREZZO
01656 0000	200 x200	1	1	€ 56,50

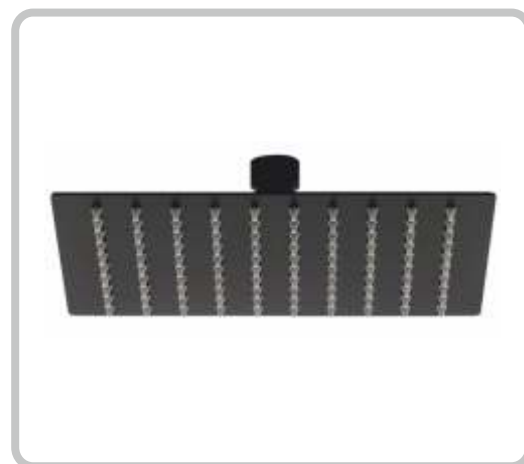

## SOFFIONE DOCCIA TONDO INOX

CODICE	DESCRIZIONE	CF	M.V.	PREZZO
01650 0000	Ø 200	1	1	€ 37,50



## SOFFIONE DOCCIA QUADRO INOX

CODICE	DESCRIZIONE	CF	M.V.	PREZZO
01652 0000	200 x 200	1	1	€ 39,00



# B10 - BRACCI DOCCIA



## BRACCIO DOCCIA A SOFFITTO IDRA 30

CODICE	DESCRIZIONE	CF	M.V.	PREZZO
01648 0000	cm 30	1	1	€ 55,00

- In ottone mm 25 x 25
- Attacco 1/2
- L 300



## BRACCIO DOCCIA TONDO PESANTE CON ROSONE

CODICE	DESCRIZIONE	CF	M.V.	PREZZO
01640 0000	mm 300	1	1	€ 24,00

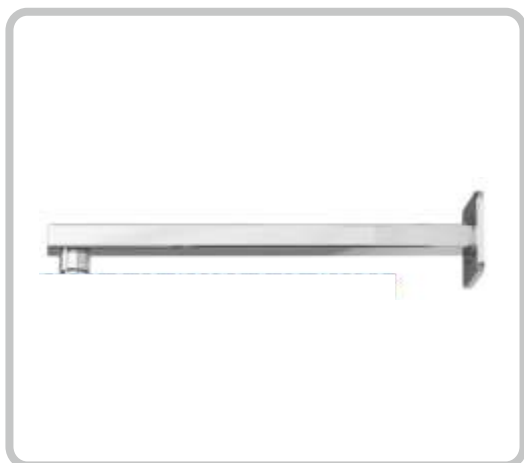

## BRACCIO DOCCIA QUADRATO PESANTE CON ROSONE

CODICE	DESCRIZIONE	CF	M.V.	PREZZO
01642 0000	mm 300	1	1	€ 37,80



## BRACCIO DOCCIA

CODICE	DESCRIZIONE	CF	M.V.	PREZZO
01644 0020	mm 200 - solo braccio	1	1	€ 7,30
01644 0000	mm 300 - solo braccio	9	1	€ 9,80



## SOFFIONE DOCCIA IN OTTONE CROMATO OLED

CODICE	DESCRIZIONE	RIF. F.	CF	M.V.	PREZZO
01606 0000	435 x 60 x 15	11709	1	1	€ 143,00

- 70 fori
- Anticalcare

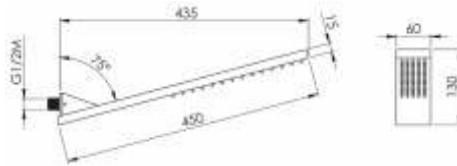

## BRACCIO DOCCIA C/SOFFIONE

CODICE	DESCRIZIONE	CF	M.V.	PREZZO
01646 0000	½ cm 30	1	1	€ 16,10



## SOFFIONE DOCCIA TIPO AMERICANO

CODICE	DESCRIZIONE	CF	M.V.	PREZZO
01666 0000	c/snodo	1	1	€ 6,63



## SOFFIONE IN ABS KIA ANTICALCARE

CODICE	DESCRIZIONE	CF	M.V.	PREZZO
01662 0000	diámetro 85 - 42 fori	1	1	€ 10,63





## SOFFIONE DOCCIA TIPO SPIAGGIA

CODICE	DESCRIZIONE	CF	M.V.	PREZZO
01667 0000	1/2 - ø 80	10	1	€ 13,20

- In ottone cromato



## SOFFIONE IN ABS FLY ANTICALCARE

CODICE	DESCRIZIONE	CF	M.V.	PREZZO
01660 0000	diámetro 120 - 57 fori	1	1	€ 27,37



## SOFFIONE LYRA 5 G

CODICE	DESCRIZIONE	RIF. F.	CF	M.V.	PREZZO
01668 0000	5 getti	11768	1	1	€ 23,90

- In ABS cromato tondo
- ø 108
- 84 fori
- Non ispezionabile

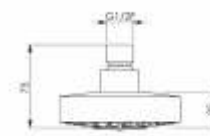

 DAMAST



## SUPPORTO A FORCELLA CON SNODO

CODICE	DESCRIZIONE	CF	M.V.	PREZZO
01624 0000	--	1	1	€ 7,59

- In ottone cromato



## SUPPORTO DOCCIA WEB

CODICE	DESCRIZIONE	RIF. F.	CF	M.V.	PREZZO
01625 0000	ABS	12159	1	1	€ 8,10

- In ABS cromato

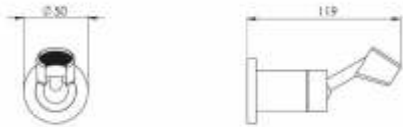

## SUPPORTO DOCCIA GIREVOLE STILO

CODICE	DESCRIZIONE	CF	M.V.	PREZZO
01626 0000	ABS	1	1	€ 3,00



## SUPPORTO DOCCIA STICH 1

CODICE	DESCRIZIONE	CF	M.V.	PREZZO
01627 0000	ABS	1	1	€ 11,00





## DOCCETTA IN ABS CROMATA STILO

CODICE	DESCRIZIONE	CF	M.V.	PREZZO
01670 0000	1/2	1	1	€ 11,80



## DOCCETTA IN ABS CROMATA QUADRA

CODICE	DESCRIZIONE	CF	M.V.	PREZZO
01672 0000	23 x 23 - 1 getto	1	1	€ 16,00

- In sacchetto.



## DOCCETTA IN OTTONE NERA OPACA RING

CODICE	DESCRIZIONE	CF	M.V.	PREZZO
01674 0000	1/2	1	1	€ 36,60



## DOCCETTA IN OTTONE NERA OPACA KUBIK

CODICE	DESCRIZIONE	CF	M.V.	PREZZO
01676 0000	1/2	1	1	€ 36,60



## DOCCETTA 1 GETTO

CODICE	DESCRIZIONE	CF	M.V.	PREZZO
01678 0000	Anticalcare	1	1	€ 4,40

- In scatola.



## DOCCETTA JESSY

CODICE	DESCRIZIONE	CF	M.V.	PREZZO
01680 0000	1 getto	1	1	€ 9,95

- In sacchetto.



## DOCCETTA EURO 3

CODICE	DESCRIZIONE	RIF. F.	CF	M.V.	PREZZO
01687 0000	--	12461	1	1	€ 10,45

- In scatola.



## DOCCETTA ELFO 3

CODICE	DESCRIZIONE	RIF. F.	CF	M.V.	PREZZO
01685 0000	3 getti	12460	1	1	€ 14,70

- ABS  
- In scatola





## DOCCETTA MILLA 1 GETTO

CODICE	DESCRIZIONE	CF	M.V.	PREZZO
01682 0000	1 getto	1	1	€ 12,35

- In scatola.



## DOCCETTA NATURE 3 GETTI

CODICE	DESCRIZIONE	RIF. F.	CF	M.V.	PREZZO
01684 0001	3 getti	12463	1	1	€ 13,33

- In scatola.



## DOCCETTA BETA 5 GETTI

CODICE	DESCRIZIONE	RIF. F.	CF	M.V.	PREZZO
01688 0000	5 getti	12467	1	1	€ 15,75

- In scatola.



## DOCCETTA IN ABS CROMATA QUADRA

CODICE	DESCRIZIONE	RIF. F.	CF	M.V.	PREZZO
01677 0000	1 getto	11384	1	1	€ 13,00

- ABS  
- In scatola

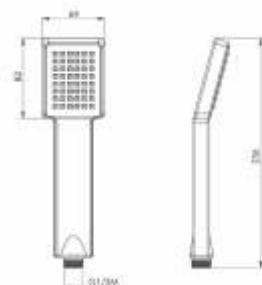

## DOCCETTA CLASSICA CON ATTACCO INCLINATO

CODICE	DESCRIZIONE	CF	M.V.	PREZZO
01679 0001	Bianca	10	1	€ 20,00
01679 0002	Nera	10	1	€ 20,00



## DOCCETTA PER MISCELATORE CUCINA

CODICE	DESCRIZIONE	CF	M.V.	PREZZO
01689 0000	in sacchetto	1	1	€ 15,26



## REGOLATORE DI PORTATA

CODICE	DESCRIZIONE	CF	M.V.	PREZZO
01698 0506	5/6 lt. min	10	1	€ 2,80
01698 0607	6/7 lt. min	10	1	€ 2,80

- Il regolatore di portata va inserito o all'interno dello snodo del soffione o all'interno del flessibile che porta alla doccia.



# B12- SHUT-OFF



## KIT SHUT-OFF BIANCO

CODICE	DESCRIZIONE	RIF. F.	CF	M.V.	PREZZO
01590 0000	20,7 l/m	12521	1	1	€ 17,70

- In PP bianco con flessibile antitorsione cm 120 PVC
- Bianco e supporto atos bianco
- In scatola



## SHUT-OFF BIANCO

CODICE	DESCRIZIONE	RIF. F.	CF	M.V.	PREZZO
01591 0000	20,7 l/m	11902	1	1	€ 6,00

- Doccetta in ABS 1 getto continuo

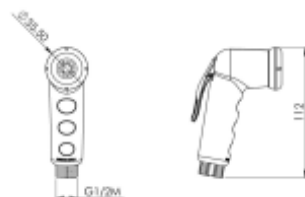

## SHUT-OFF CROMATO

CODICE	DESCRIZIONE	RIF. F.	CF	M.V.	PREZZO
01592 0000	20,7 l/m	11879	1	1	€ 12,40

- Doccetta in ABS 1 getto continuo



## FLESSIBILE DOCCIA PVC BIANCO

CODICE	DESCRIZIONE	CF	M.V.	PREZZO
01695 0000	1,5 mt	1	1	€ 9,50

## FLESSIBILE DOCCIA

CODICE	DESCRIZIONE	CF	M.V.	PREZZO
01690 0050	½ x ½ cm 50	1	1	€ 5,33
01690 0150	½ x ½ cm 150	1	1	€ 4,87
01690 0200	½ x ½ cm 200	1	1	€ 5,75



## FLESSIBILE DOCCIA ESTENSIBILE

CODICE	DESCRIZIONE	CF	M.V.	PREZZO
01692 0000	180 - 200	1	1	€ 7,82



## FLESSIBILE DOCCIA GRIGIO METALLIZZATO

CODICE	DESCRIZIONE	CF	M.V.	PREZZO
01694 0150	cm 150	1	1	€ 16,44
01694 0200	cm 200	1	1	€ 21,35



## FLESSIBILE DOCCIA NERO OPACO

CODICE	DESCRIZIONE	CF	M.V.	PREZZO
01696 0150	cm 150	1	1	€ 19,90





# ELEMENTI BAGNO

 DAMAST

**Laneri**  
sanitary ware

 JMC  
ARREDO BAGNO

**Roca**



# ACCESSORI



GIAVA

 METAFORM®

**fischer** 

MISCELATORI E

ACCESSORI

*Una nuova via è una nuova opportunità.  
Non avere paura a percorrerla,  
puoi sempre tornare indietro.*

*S. Russo*



# ELEMENTI BAGNO



## MISCELATORI



## ACCESSORI



## FLESSIBILI



Rubetterie Matella Giovanni  
*evolution*



## MISCELATORE LAVABO PRINCE

CODICE	DESCRIZIONE	CF	M.V.	PREZZO
01721 0000	lavabo	1	1	€ 48,68



## MISCELATORE BIDET PRINCE

CODICE	DESCRIZIONE	CF	M.V.	PREZZO
01722 0000	bidet	1	1	€ 48,68



## MISCELATORE DOCCIA INCASSO PRINCE

CODICE	DESCRIZIONE	CF	M.V.	PREZZO
01723 0000	doccia	1	1	€ 47,20



## MISCELATORE VASCA PRINCE

CODICE	DESCRIZIONE	CF	M.V.	PREZZO
01724 0000	vasca	1	1	€ 68,05



## MISCELATORE LAVELLO A PARETE PRINCE

CODICE	DESCRIZIONE	CF	M.V.	PREZZO
01726 0000	Prince	10	1	€ 60,52



## C2 - MISCELATORI SUNNY



### MISCELATORE LAVABO SUNNY

CODICE	DESCRIZIONE	CF	M.V.	PREZZO
01751 0000	Cartuccia Ø 35	12	1	€ 59,00



### MISCELATORE BIDET SUNNY

CODICE	DESCRIZIONE	CF	M.V.	PREZZO
01752 0000	Cartuccia Ø 35	12	1	€ 59,00



### MISCELATORE DOCCIA INCASSO SUNNY

CODICE	DESCRIZIONE	CF	M.V.	PREZZO
01753 0000	Doccia	1	1	€ 42,70
01753 0100	c/deviatore	1	1	€ 90,50

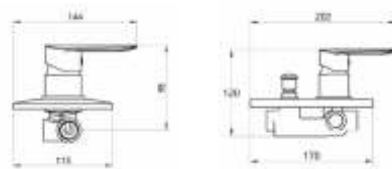

### MISCELATORE DOCCIA ESTERNA SUNNY

CODICE	DESCRIZIONE	CF	M.V.	PREZZO
01755 0000	Cartuccia Ø 35	12	1	€ 53,50

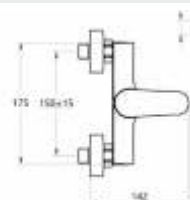

### MISCELATORE VASCA SUNNY

CODICE	DESCRIZIONE	CF	M.V.	PREZZO
01754 0000	Cartuccia Ø 35	12	1	€ 77,00

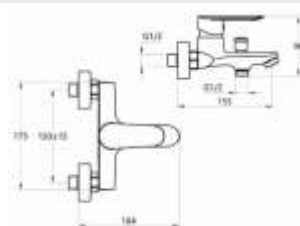

## MISCELATORE LAVABO NIKO IN ACCIAIO SATINATO

CODICE	DESCRIZIONE	CF	M.V.	PREZZO
01761 0000	Cartuccia $\varnothing$ 35	12	1	€ 63,75



## MISCELATORE LAVABO NIKO IN ACCIAIO SATINATO ALTO

CODICE	DESCRIZIONE	CF	M.V.	PREZZO
01766 0000	Cartuccia $\varnothing$ 35	12	1	€ 72,50



## MISCELATORE BIDET NIKO IN ACCIAIO SATINATO

CODICE	DESCRIZIONE	CF	M.V.	PREZZO
01767 0000	Cartuccia $\varnothing$ 35	12	1	€ 63,75



## MISCELATORE DOCCIA ESTERNA NIKO IN ACCIAIO SATINATO

CODICE	DESCRIZIONE	CF	M.V.	PREZZO
01765 0000	Cartuccia $\varnothing$ 35	12	1	€ 96,00

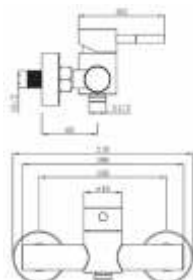

## C3 - MISCELATORI NIKO



### MISCELATORE DOCCIA INCASSO NIKO IN ACCIAIO SATINATO

CODICE	DESCRIZIONE	CF	M.V.	PREZZO
01763 0000	1 via	12	1	€ 98,00

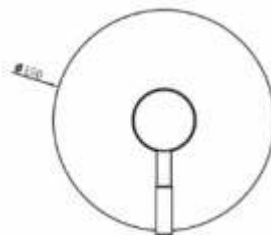

### MISCELATORE DOCCIA INCASSO C/DEVIATORE NIKO IN ACCIAIO SATINATO

CODICE	DESCRIZIONE	CF	M.V.	PREZZO
01763 0100	Cartuccia Ø 35	12	1	€ 169,00

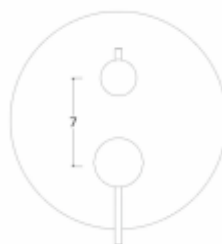

### MISCELATORE VASCA NIKO IN ACCIAIO SATINATO

CODICE	DESCRIZIONE	CF	M.V.	PREZZO
01764 0000	Cartuccia Ø 35	12	1	€ 114,00

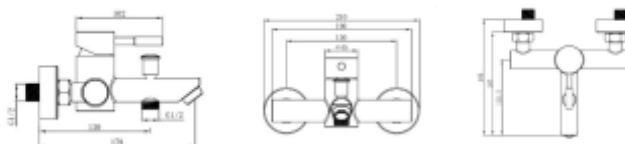

## MISCELATORE LAVABO KUBO

CODICE	DESCRIZIONE	CF	M.V.	PREZZO
01731 0000	lavabo	12	1	€ 97,50

- Fornito c/piletta click clack



## MISCELATORE BIDET KUBO

CODICE	DESCRIZIONE	CF	M.V.	PREZZO
01732 0000	bidet	12	1	€ 97,50

- Fornito c/piletta click clack



## MISCELATORE DOCCIA INCASSO KUBO

CODICE	DESCRIZIONE	CF	M.V.	PREZZO
01733 0000	doccia	12	1	€ 54,50
01733 0100	c/deviatore	12	1	€ 93,00

- Cartuccia  $\varnothing$  35



## MISCELATORE VASCA KUBO

CODICE	DESCRIZIONE	CF	M.V.	PREZZO
01734 0000	vasca	12	1	€ 135,50



## C5 - MISCELATORI 70SETTE



### MISCELATORE LAVABO 70SETTE

CODICE	DESCRIZIONE	CF	M.V.	PREZZO
01741 0000	cartuccia Ø 35	12	1	€ 86,90



### MISCELATORE LAVABO 70SETTE ALTO

CODICE	DESCRIZIONE	CF	M.V.	PREZZO
01740 0000	cartuccia Ø 35	12	1	€ 130,00

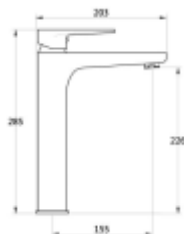

### MISCELATORE BIDET 70SETTE

CODICE	DESCRIZIONE	CF	M.V.	PREZZO
01742 0000	cartuccia Ø 35	12	1	€ 86,90



### MISCELATORE DOCCIA INCASSO 70SETTE

CODICE	DESCRIZIONE	CF	M.V.	PREZZO
01743 0000	doccia	12	1	€ 49,00
01743 0100	c/deviatore	12	1	€ 99,00

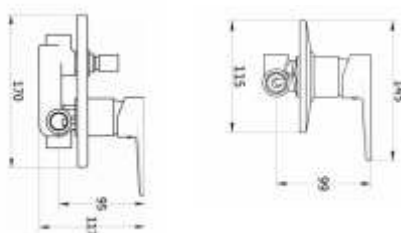

## MISCELATORE LAVABO SKATE

CODICE	DESCRIZIONE	CF	M.V.	PREZZO
01771 0000	Cartuccia progressiva	12	1	€ 204,00

- Su ordinazione anche colore nero e canna di fucile.

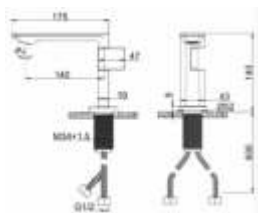

## MISCELATORE LAVABO ALTO SKATE

CODICE	DESCRIZIONE	CF	M.V.	PREZZO
01770 0000	Cartuccia progressiva	12	1	€ 256,00

- Su ordinazione anche colore nero e canna di fucile.

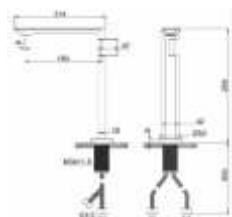

## MISCELATORE BIDET SKATE

CODICE	DESCRIZIONE	CF	M.V.	PREZZO
01772 0000	Cartuccia progressiva	12	1	€ 204,00

- Su ordinazione anche colore nero e canna di fucile.



## MISCELATORE DOCCIA INCASSO SKATE

CODICE	DESCRIZIONE	CF	M.V.	PREZZO
01773 0000	1 via	12	1	€ 160,00
01773 0100	2 vie	12	1	€ 175,00

- Su ordinazione anche colore nero e canna di fucile.



## MISCELATORE VASCA SKATE

CODICE	DESCRIZIONE	CF	M.V.	PREZZO
01774 0000	Cartuccia progressiva	12	1	€ 326,00

- Su ordinazione anche colore nero e canna di fucile.

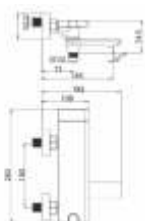

# C7 - RUBINETTERIA MATELLA JOLLY

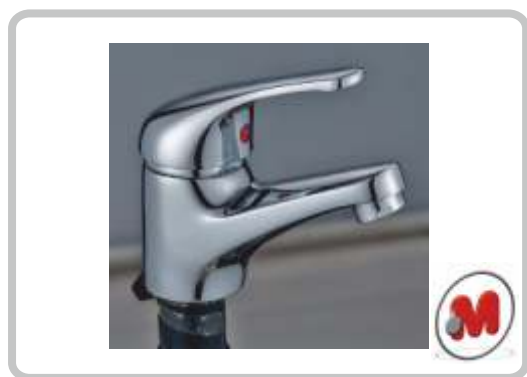

## MISCELATORE LAVABO JOLLY

CODICE	DESCRIZIONE	RIF. F.	CF	M.V.	PREZZO
01801 0000	Jolly	J41	1	1	€ 61,75

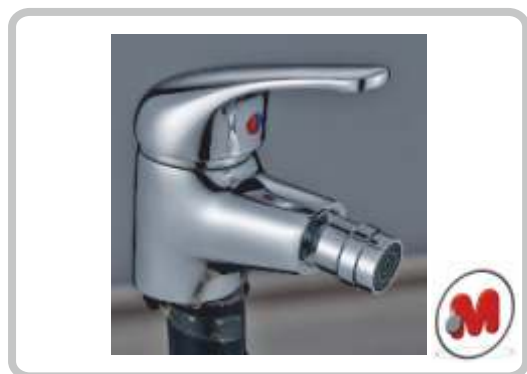

## MISCELATORE BIDET JOLLY

CODICE	DESCRIZIONE	RIF. F.	CF	M.V.	PREZZO
01802 0000	Jolly	J42	1	1	€ 61,75



## MISCELATORE DOCCIA INCASSO JOLLY

CODICE	DESCRIZIONE	RIF. F.	CF	M.V.	PREZZO
01803 0000	Jolly	J43	1	1	€ 55,50



## MISCELATORE DOCCIA ESTERNO JOLLY

CODICE	DESCRIZIONE	RIF. F.	CF	M.V.	PREZZO
01805 0000	Jolly	J45	1	1	€ 73,50

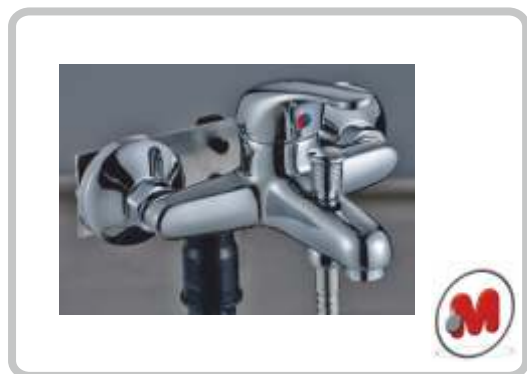

## MISCELATORE VASCA JOLLY

CODICE	DESCRIZIONE	RIF. F.	CF	M.V.	PREZZO
01804 0000	Jolly	J44	1	1	€ 88,00



## MISCELATORE LAVABO PERSEO

CODICE	DESCRIZIONE	CF	M.V.	PREZZO
01811 0000	Miscelatore lavabo Perseo	1	1	€ 91,50



## MISCELATORE BIDET PERSEO

CODICE	DESCRIZIONE	CF	M.V.	PREZZO
01812 0000	Miscelatore bidet Perseo	1	1	€ 91,50



## MISCELATORE DOCCIA INCASSO PERSEO

CODICE	DESCRIZIONE	CF	M.V.	PREZZO
01813 0000	--	1	1	€ 56,50



## MISCELATORE DOCCIA INCASSO PERSEO

CODICE	DESCRIZIONE	CF	M.V.	PREZZO
01813 0100	c/deviatore	1	1	€ 153,00

## MISCELATORE VASCA PERSEO

CODICE	DESCRIZIONE	CF	M.V.	PREZZO
01814 0000	c/supporto a muro	1	1	€ 133,50



## MISCELATORE DOCCIA ESTERNO PERSEO

CODICE	DESCRIZIONE	CF	M.V.	PREZZO
01815 0000	c/supporto a muro	1	1	€ 115,00

# C9 - RUBINETTERIA MATELLA TERRA



## MISCELATORE LAVABO TERRA

CODICE	DESCRIZIONE	CF	M.V.	PREZZO
01821 0000	Miscelatore lavabo Terra	1	1	€ 103,90

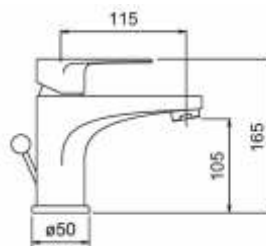

## MISCELATORE BIDET TERRA

CODICE	DESCRIZIONE	CF	M.V.	PREZZO
01822 0000	Miscelatore bidet Terra	1	1	€ 103,90

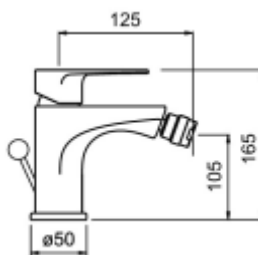

## MISCELATORE DOCCIA INCASSO TERRA

CODICE	DESCRIZIONE	CF	M.V.	PREZZO
01823 0000	--	1	1	€ 58,00



## MISCELATORE DOCCIA INCASSO TERRA

CODICE	DESCRIZIONE	CF	M.V.	PREZZO
01823 0100	c/deviatore automatico	1	1	€ 155,00



## MISCELATORE VASCA TERRA

CODICE	DESCRIZIONE	CF	M.V.	PREZZO
01824 0000	c/supporto a muro	1	1	€ 170,20



## MISCELATORE DOCCIA ESTERNO TERRA

CODICE	DESCRIZIONE	CF	M.V.	PREZZO
01825 0000	c/supporto a muro	1	1	€ 118,00



# C10 - RUBINETTERIA MATELLA TERRA NERO OPACO

## MISCELATORE LAVABO TERRA NERO OPACO

CODICE	DESCRIZIONE	RIF. F.	CF	M.V.	PREZZO
01841 0000	nero opaco	1141CL50	1	1	€ 160,00



## MISCELATORE BIDET TERRA NERO OPACO

CODICE	DESCRIZIONE	RIF. F.	CF	M.V.	PREZZO
01842 0000	nero opaco	1142CL50	1	1	€ 160,00



## MISCELATORE DOCCIA INCASSO TERRA NERO OPACO

CODICE	DESCRIZIONE	RIF. F.	CF	M.V.	PREZZO
01843 0000	c/deviatore automatico	1143VCL50	1	1	€ 208,00



# C11- RUBINETTERIA MATELLA CUCINA



## MONOCOMANDO LAVELLO BOCCA GIREVOLE

CODICE	DESCRIZIONE	RIF. F.	CF	M.V.	PREZZO
01847 0000	--	2047	1	1	€ 105,95



## MONOCOMANDO LAVELLO BOCCA GIREVOLE

CODICE	DESCRIZIONE	RIF. F.	CF	M.V.	PREZZO
01847 0100	c/attacco lavastoviglie	2047L	1	1	€ 179,00

- Funziona come se avesse un rubinetto  
3 vie incorporato, che apre e chiude  
l'acqua per la lavastoviglie.



## MONOCOMANDO LAVELLO BOCCA GIREVOLE

CODICE	DESCRIZIONE	RIF. F.	CF	M.V.	PREZZO
01847 0200	c/attacco serbatoio	2047S	1	1	€ 164,00



## MONOCOMANDO LAVELLO LATERALE CANNA ALTA

CODICE	DESCRIZIONE	RIF. F.	CF	M.V.	PREZZO
01848 0000	--	2048	1	1	€ 96,50



## MONOCOMANDO LAVELLO LATERALE CANNA ALTA

CODICE	DESCRIZIONE	RIF. F.	CF	M.V.	PREZZO
01848 0100	bianco	2048B	1	1	€ 109,30

# C11- RUBINETTERIA MATELLA LAVANDERIA

## MONOCOMANDO LAVELLO BOCCA GIREVOLE

CODICE	DESCRIZIONE	CF	M.V.	PREZZO
01846 0000	Monocomando lavello bocca girevole	1	1	€ 117,00



## MONOCOMANDO LAVELLO PARETE FRONTALE

CODICE	DESCRIZIONE	RIF. F.	CF	M.V.	PREZZO
01846 0100	Maniglia corta	2046D	1	1	€ 118,30



## MONOCOMANDO LAVELLO PARETE FRONTALE

CODICE	DESCRIZIONE	RIF. F.	CF	M.V.	PREZZO
01846 0200	Canna superiore	2046DC9	1	1	€ 140,00



# C12 - RUBINETTERIA MATELLA CUCINA JOLLY



## MISCELATORE LAVABO CANNA BASSA

CODICE	DESCRIZIONE	RIF. F.	CF	M.V.	PREZZO
01850 0000	Jolly	J47	1	1	€ 55,00



## MISCELATORE LAVELLO CANNA ALTA

CODICE	DESCRIZIONE	RIF. F.	CF	M.V.	PREZZO
01852 0000	Jolly	J48	1	1	€ 62,60



## MISCELATORE LAVELLO A PARETE

CODICE	DESCRIZIONE	RIF. F.	CF	M.V.	PREZZO
01854 0000	Jolly	J46	1	1	€ 76,00



# C13 - RUBINETTERIA MATELLA MONOFORO

## MONOFORO LAVELLO LIBERTY

CODICE	DESCRIZIONE	CF	M.V.	PREZZO
01876 0000	Monoforo lavello Liberty	1	1	€ 125,40



## MONOFORO LAVELLO CANNA JOTA

CODICE	DESCRIZIONE	CF	M.V.	PREZZO
01870 0000	Maniglia in ottone	1	1	€ 88,50



## MONOFORO LAVELLO CANNA JOTA

CODICE	DESCRIZIONE	RIF. F.	CF	M.V.	PREZZO
01872 0000	Maniglia in zama	00104M1	1	1	€ 73,80



# C14- RUBINETTERIA MATELLA LAVANDERIA



## LAVELLO PARETE CON CANNA "S" INFERIORE

CODICE	DESCRIZIONE	CF	M.V.	PREZZO
01860 0000	Maniglia in ottone	1	1	€ 87,25



## LAVELLO PARETE CON CANNA "S" INFERIORE

CODICE	DESCRIZIONE	RIF. F.	CF	M.V.	PREZZO
01862 0000	c/maniglia in zama	00110M1	1	1	€ 78,00



## RUBINETTO LAVELLO C/CANNA SUPERIORE

CODICE	DESCRIZIONE	RIF. F.	CF	M.V.	PREZZO
01864 0000	Maniglia in ottone	00110U	1	1	€ 87,25



## RUBINETTO LAVELLO C/CANNA SUPERIORE

CODICE	DESCRIZIONE	RIF. F.	CF	M.V.	PREZZO
01866 0000	c/maniglia in zama	00110M1U	1	1	€ 78,00



## LAVELLO PARETE CON ATTACCO LAVATRICE

CODICE	DESCRIZIONE	RIF. F.	CF	M.V.	PREZZO
01868 0000	Lavello parete c/attacco lavatrice	006M1	1	1	€ 110,40





Matella Giovanni Rubinetterie

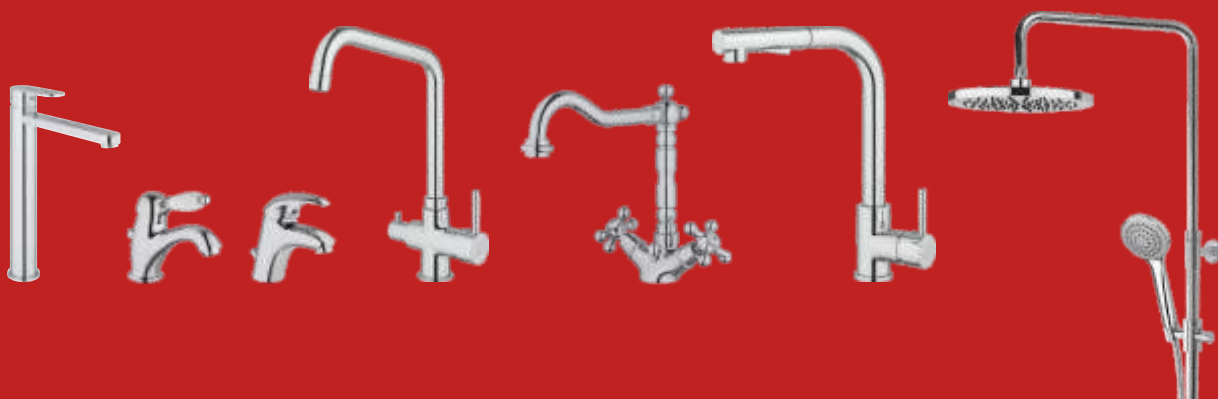

# C16 - MISCELATORI CUCINA



## RUBINETTO LAVELLO A COLONNA

CODICE	DESCRIZIONE	CF	M.V.	PREZZO
01900 0000	1 via	1	1	€ 22,94



## RUBINETTO A SNODO 1 POMELLO A MURO

CODICE	DESCRIZIONE	CF	M.V.	PREZZO
01904 0000	½ 1 via	1	1	€ 22,20



## RUBINETTO A SNODO C/ATTACCO LAVATRICE

CODICE	DESCRIZIONE	CF	M.V.	PREZZO
01905 0000	1/2 x 3/4	3	1	€ 37,50

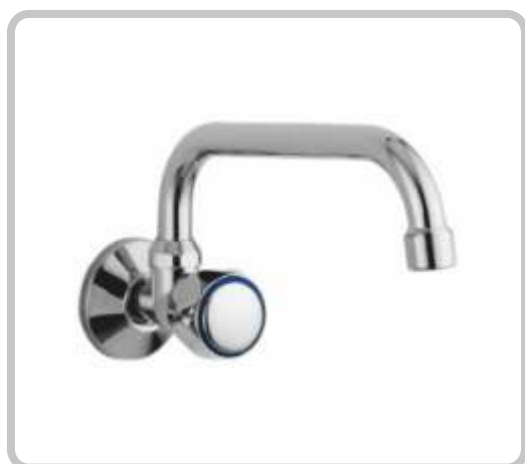

## RUBINETTO A SNODO 1 POMELLO A MURO CANNA U

CODICE	DESCRIZIONE	CF	M.V.	PREZZO
01906 0000	½ 1 via	1	1	€ 26,30



## MISCELATORE LAVELLO CANNA ALTA

CODICE	DESCRIZIONE	CF	M.V.	PREZZO
01908 0000	Cromo lucido	1	1	€ 53,75



## MISCELATORE LAVELLO LATERALE CANNA ALTA AVENA

CODICE	DESCRIZIONE	CF	M.V.	PREZZO
01920 0000	Avana	12	1	€ 79,50



## MISCELATORE LAVELLO LATERALE CANNA ALTA NERO

CODICE	DESCRIZIONE	CF	M.V.	PREZZO
01922 0000	nero	12	1	€ 79,50



## MISCELATORE LAVELLO LATERALE CANNA ALTA VECCHIO RAME

CODICE	DESCRIZIONE	CF	M.V.	PREZZO
01924 0400	vecchio rame	12	1	€ 82,90



# C16 - MISCELATORI CUCINA



## MISCELATORE LAVELLO CANNA GIREVOLE JACK

CODICE	DESCRIZIONE	CF	M.V.	PREZZO
01914 0000	cartuccia Ø 35	12	1	€ 70,75

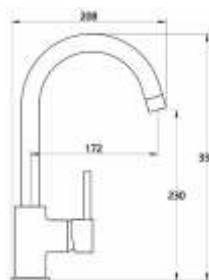

## MISCELATORE LAVELLO CUCINA ACCIAIO SATINATO NIKO

CODICE	DESCRIZIONE	CF	M.V.	PREZZO
01915 0000	Cartuccia Ø 35	12	1	€ 77,00

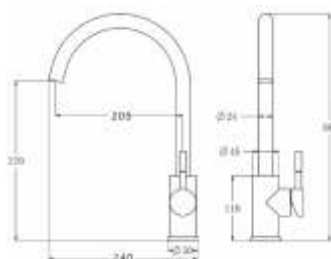

## MISCELATORE LAVELLO CANNA ALTA GIREVOLE KUBO

CODICE	DESCRIZIONE	CF	M.V.	PREZZO
01916 0000	cartuccia Ø 35	12	1	€ 119,00

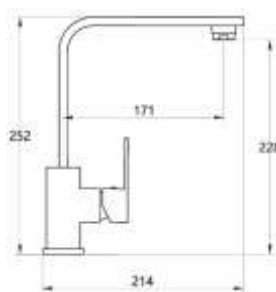

## MISCELATORE LAVELLO CUCINA BOCCA GIREVOLE SKATE

CODICE	DESCRIZIONE	CF	M.V.	PREZZO
01918 0000	Cartuccia progressiva	12	1	€ 158,00

- Su ordinazione anche colore nero e canna di fucile.

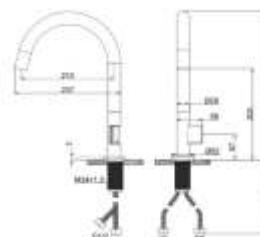

## MISCELATORE LAVELLO LATERALE CANNA ALTA A PONTE

CODICE	DESCRIZIONE	CF	M.V.	PREZZO
01909 0000	Cromo	1	1	€ 66,25



## MISCELATORE LAVELLO SNAKE

CODICE	DESCRIZIONE	CF	M.V.	PREZZO
01910 0100	bianco	1	1	€ 97,50
01910 0200	grigio	1	1	€ 97,50
01910 0300	nero	1	1	€ 97,50

- Canna orientabile in gomma colorata.



## CANNA COLORATA PER MISCELATORE SNAKE

CODICE	DESCRIZIONE	CF	M.V.	PREZZO
01912 0100	bianca	1	1	€ 26,00
01912 0200	grigia	1	1	€ 26,00
01912 0300	nera	1	1	€ 26,00



## MISCELATORE LAVELLO CUCINA C/CANNA FLESSIBILE ORIENTABILE

CODICE	DESCRIZIONE	CF	M.V.	PREZZO
01913 0000	Con doccetta	12	1	€ 245,00

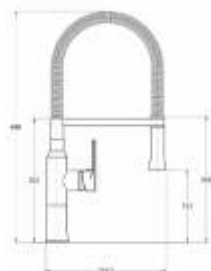

# C25 - RUBINETTI LAVATRICE



## FALSO CENTRO 1/2 x 3/4

CODICE	DESCRIZIONE	CF	M.V.	PREZZO
02450 0000	1/2 x 3/4	10	1	€ 3,75

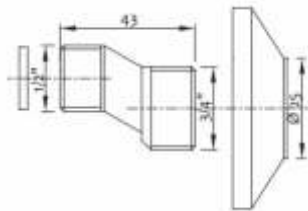

## FALSO CENTRO 1/2 x 3/4 CM4

CODICE	DESCRIZIONE	CF	M.V.	PREZZO
02452 0000	1/2 x 3/4 CM4	10	1	€ 10,25



## RUBINETTO COLLO DI CIGNO TEMPORIZZATO

CODICE	DESCRIZIONE	CF	M.V.	PREZZO
04030 0400	1/2	1	1	€ 40,50



**New**

## RUBINETTO TEMPORIZZATO PER ORINATORIO

CODICE	DESCRIZIONE	CF	M.V.	PREZZO
02230 0000	Ottone cromato	1	1	€ 60,75

- Tempo di apertura: 6-10 secondi
- Collegamento 1/2



# C17 - MISCELATORI DOCCETTA ESTRAIBILE

## MISCELATORE LAVELLO CANNA BASSA DOCCETTA ESTRAIBILE

CODICE	DESCRIZIONE	CF	M.V.	PREZZO
01702 0000	lavello	1	1	€ 89,50



## FLESSIBILE DOCCETTA ESTRAIBILE

CODICE	DESCRIZIONE	CF	M.V.	PREZZO
01700 0000	cm 120 nylon	1	1	€ 12,00



## FLESSIBILE DOCCETTA ESTRAIBILE

CODICE	DESCRIZIONE	CF	M.V.	PREZZO
01701 0000	cm 150 acciaio	1	1	€ 9,85



# C18 - MISCELATORI A PEDALE



## RUBINETTO A PEDALE PARETE/PAVIMENTO

CODICE	DESCRIZIONE	CF	M.V.	PREZZO
01760 0000	1/2	1	1	€ 100,50



## MISCELATORE MONOPEDALE PROGRESSIVO

CODICE	DESCRIZIONE	CF	M.V.	PREZZO
01762 0000	1/2	1	1	€ 107,25

- Installazione a parete.
- Installazione a pavimento.



## MISCELATORE DOPPIO PEDALE

CODICE	DESCRIZIONE	CF	M.V.	PREZZO
01759 0000	1/2	10	1	€ 148,00

- Installazione parete/pavimento
- Corpo ottone
- In dotazione: valvole di non ritorno; guarnizioni con filtro Inox; viti di fissaggio in acciaio Ø 10 mm



## BOCCA DI EROGAZIONE PER MISCELATORE A PEDALE

CODICE	DESCRIZIONE	CF	M.V.	PREZZO
01768 0000	3/4	1	1	€ 38,90



## CANNA DI RICAMBIO ALTA PER LAVELLO

CODICE	DESCRIZIONE	CF	M.V.	PREZZO
02000 0000	in acciaio	1	1	€ 12,50



## CANNA DI RICAMBIO ALTA AD OMBRELLO

CODICE	DESCRIZIONE	CF	M.V.	PREZZO
02002 0000		1	1	€ 11,92



## CANNA DI RICAMBIO ALTA A PONTE

CODICE	DESCRIZIONE	CF	M.V.	PREZZO
02003 0000	3/4	1	1	€ 21,50



## ADATTATORE UNIVERSALE PER CANNA DA 3/4

CODICE	DESCRIZIONE	CF	M.V.	PREZZO
02008 0000	3/4	1	1	€ 4,26





## CANNA DI RICAMBIO PER LAVELLO A PARETE

CODICE	DESCRIZIONE	CF	M.V.	PREZZO
02004 1800	cm 18 Matella	1	1	€ 23,80
02004 2200	cm 22 Matella	1	1	€ 26,00



## CANNA DI RICAMBIO PER LAVELLO A PARETE

CODICE	DESCRIZIONE	CF	M.V.	PREZZO
02006 1500	cm 15	1	1	€ 16,85
02006 2000	cm 20	1	1	€ 16,55
02006 2500	cm 25	1	1	€ 16,55



## CANNA JOTA PER LAVELLO MONOFORO

CODICE	DESCRIZIONE	CF	M.V.	PREZZO
02010 0000	Canna Jota Matella	1	1	€ 21,50



## CANNA JOTA PER LAVELLO MONOFORO

CODICE	DESCRIZIONE	CF	M.V.	PREZZO
02012 0000	Canna Jota universale	1	1	€ 9,95



## CANNA ESSE PER GRUPPO LAVELLO A MURO

CODICE	DESCRIZIONE	CF	M.V.	PREZZO
02014 1800	cm 18 Matella	1	1	€ 22,50
02014 2200	cm 22 Matella	1	1	€ 23,50
02014 3000	cm 30 Matella	1	1	€ 24,50



## CANNA ESSE PER GRUPPO LAVELLO A MURO

CODICE	DESCRIZIONE	CF	M.V.	PREZZO
02016 0000	cm 18	1	1	€ 10,86



## CANNA ALTA PER GRUPPO LAVELLO A MURO

CODICE	DESCRIZIONE	CF	M.V.	PREZZO
02018 0000	cm 18	1	1	€ 9,16



## “OR” DI RICAMBIO PER CANNE RUBINETTO

CODICE	DESCRIZIONE	CF	M.V.	PREZZO
02026 1210	12.10 x 2.70	100	100	€ 0,08
02026 1360	13.60 x 2.70	100	100	€ 0,09

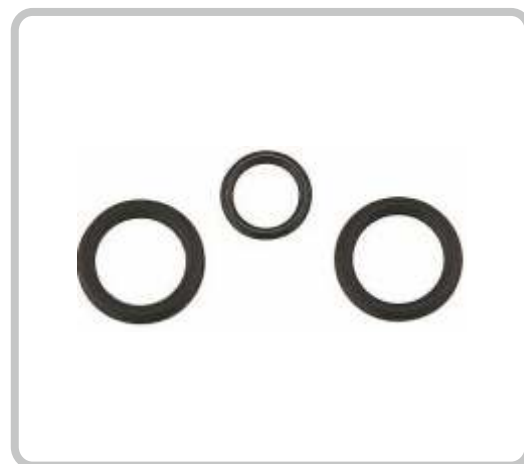

## C20 - LEVE DI RICAMBIO



### LEVA CLINICA

CODICE	DESCRIZIONE	CF	M.V.	PREZZO
02020 0000	per miscelatori cartuccia Ø 40	1	1	€ 14,00



### LEVA RICAMBIO PER MISCELATORE

CODICE	DESCRIZIONE	CF	M.V.	PREZZO
02022 0000	cartuccia Ø 40	1	1	€ 7,78



### LEVA RICAMBIO SQUADRATA

CODICE	DESCRIZIONE	CF	M.V.	PREZZO
02023 0000	Cartuccia Ø 40	1	1	€ 13,70



### POMELLO CROMATO PER RUBINETTO

CODICE	DESCRIZIONE	CF	M.V.	PREZZO
02027 0020	8 x 20	20	1	€ 5,50
02027 0024	8 x 24	20	1	€ 5,50

- In ogni pomello c'è un segnalatore rosso e uno blu.



## PIASTRA PER MISCELATORI INCASSO DOCCIA

CODICE	DESCRIZIONE	CF	M.V.	PREZZO
02024 0000	cartuccia Ø 40	1	1	€ 7,84



## PIASTRA PER MISCELATORE DOCCIA INCASSO QUADRATA

CODICE	DESCRIZIONE	CF	M.V.	PREZZO
02025 0000	Cartuccia Ø 35	10	1	€ 12.50



## BASSETTA IN METALLO PER MISCELATORE

CODICE	DESCRIZIONE	CF	M.V.	PREZZO
02028 0000	Lavello - Lavabo - Bidet	1	1	€ 4,80

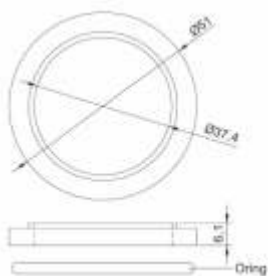

## PROLUNGA PER ESTENSIONE CORPO MISCELATORE INCASSO DOCCIA

CODICE	DESCRIZIONE	CF	M.V.	PREZZO
02029 0000	1-1/4	1	1	€ 115,00

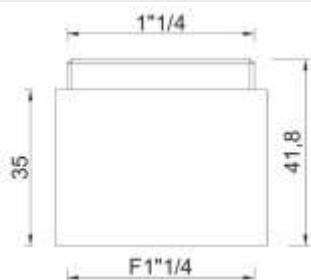

## C22 - CARTUCCE PER MISCELATORI



### CARTUCCIA A DISCHI CERAMICA Ø 40

CODICE	DESCRIZIONE	CF	M.V.	PREZZO
02030 0000	Alta	1	1	€ 5,00



### CARTUCCIA A DISCHI CERAMICA Ø 40

CODICE	DESCRIZIONE	CF	M.V.	PREZZO
02032 0000	Bassa	1	1	€ 5,00



### CARTUCCIA A DISCHI CERAMICA Ø 35

CODICE	DESCRIZIONE	CF	M.V.	PREZZO
02034 0000	Alta	1	1	€ 5,00



### CARTUCCIA A DISCHI CERAMICA Ø 35

CODICE	DESCRIZIONE	CF	M.V.	PREZZO
02036 0000	Bassa	1	1	€ 5,00

## CARTUCCIA CERAMICA MAMOLI QUARZOVIP 3D 0004/V

CODICE	DESCRIZIONE	CF	M.V.	PREZZO
02038 0000	Ø 37 x 59 H	1	1	€ 102,50



## CARTUCCIA CERAMICA MAMOLI QUARZOVIP 2D 0019/V

CODICE	DESCRIZIONE	CF	M.V.	PREZZO
02040 0000	Ø 43 x 63 H	1	1	€ 102,50



## CARTUCCIA CERAMICA ZUCCHETTI R98103

CODICE	DESCRIZIONE	CF	M.V.	PREZZO
02042 0000	Ø 39 x 63 H	1	1	€ 80,00



## CARTUCCIA CERAMICA ZUCCHETTI R9734P

CODICE	DESCRIZIONE	CF	M.V.	PREZZO
02044 0000	Ø 38,5 x 63 H	1	1	€ 134,00



## C22 - CARTUCCE PER MISCELATORI



### CARTUCCIA CERAMICA RAF TAMIGI TIPO VECCHIO X163

CODICE	DESCRIZIONE	CF	M.V.	PREZZO
02046 0000	Ø 49 x 66 H	1	1	€ 167,00



### CARTUCCIA CERAMICA RAF TAMIGI X102

CODICE	DESCRIZIONE	CF	M.V.	PREZZO
02048 0000	Ø 49 x 65 H	1	1	€ 157,00



### CARTUCCIA CERAMICA DIAMETRO 35 KUBO

CODICE	DESCRIZIONE	CF	M.V.	PREZZO
02037 0000	Ø 35	1	1	€ 6,50

- Per miscelatori modello Kubo.



### CARTUCCIA CERAMICA IDEAL STANDARD

CODICE	DESCRIZIONE	CF	M.V.	PREZZO
02052 0000	Ø 46 x 58 H	1	1	€ 152,00

## CARTUCCIA CERAMICA NOBILI

CODICE	DESCRIZIONE	CF	M.V.	PREZZO
02054 0000	Ø 45 x 61 H	1	1	€ 82,00

- Senza distributore



## CARTUCCIA CERAMICA PAINI

CODICE	DESCRIZIONE	CF	M.V.	PREZZO
02056 0000	Ø 40 x 79 H	1	1	€ 45,90

- Serie COOPER, ATOMIX 2000, DILOS



## CARTUCCIA CERAMICA PAINI RIF. 53CC956G350

CODICE	DESCRIZIONE	CF	M.V.	PREZZO
02058 0000	Ø 36 x 59,5 H	1	1	€ 52,50



## CARTUCCIA CERAMICA PAINI

CODICE	DESCRIZIONE	CF	M.V.	PREZZO
02060 0000	Ø 26 x 54 H	1	1	€ 45,90

- Serie LADY



## C22 - CARTUCCE PER MISCELATORI



### CARTUCCIA CERAMICA GALATRON G11

CODICE	DESCRIZIONE	CF	M.V.	PREZZO
02062 0000	Ø 47 x 66 H	1	1	€ 37,50

- Gnutti Sebastiano



### CARTUCCIA CERAMICA GS

CODICE	DESCRIZIONE	CF	M.V.	PREZZO
02064 0000	Ø 50 x 66 H	1	1	€ 123,00

- Gnutti Sebastiano



### CARTUCCIA CERAMICA METALLI PRESSATI BONOMI

CODICE	DESCRIZIONE	CF	M.V.	PREZZO
02066 0000	Ø 47 x 66 H	1	1	€ 75,00
02066 0001	Ø 47 x 66 H compatibile	1	1	€ 55,00



### CARTUCCIA CERAMICA CRISTINA CR45

CODICE	DESCRIZIONE	CF	M.V.	PREZZO
02068 0000	Ø 45 x 63 H	1	1	€ 52,50



### CARTUCCIA CERAMICA KEROX K25OPCS

CODICE	DESCRIZIONE	CF	M.V.	PREZZO
02070 0000	Ø 25 x 55 H	1	1	€ 36,50

## CARTUCCIA CERAMICA G25 OPEN EVO 0/24°

CODICE	DESCRIZIONE	CF	M.V.	PREZZO
02065 0000	Ø 25	1	1	€ 18,00



## CARTUCCIA CERAMICA G25 OPEN EVO

CODICE	DESCRIZIONE	CF	M.V.	PREZZO
02067 0000	Ø 25	1	1	€ 18,00



## CARTUCCIA CERAMICA G25-TR

CODICE	DESCRIZIONE	CF	M.V.	PREZZO
02069 0000	Ø 25	1	1	€ 18,00



## CARTUCCIA CERAMICA G25DA

CODICE	DESCRIZIONE	CF	M.V.	PREZZO
02059 0000	Ø 25	1	1	€ 18,00



## C22 - CARTUCCE PER MISCELATORI

**New**



### CARTUCCIA CERAMICA G25 100° G TR

CODICE	DESCRIZIONE	CF	M.V.	PREZZO
02057 0000	Ø 25	1	1	€ 18,00

- Paini

**New**



### CARTUCCIA CERAMICA G35 E.S. EVO C1-0/90° DX

CODICE	DESCRIZIONE	CF	M.V.	PREZZO
02061 0000	Ø 35	1	1	€ 18,00

- Paini

**New**



### CARTUCCIA CERAMICA G40D EVO C1

CODICE	DESCRIZIONE	CF	M.V.	PREZZO
02063 0000	Ø 40	1	1	€ 18,00

**New**



### CARTUCCIA CERAMICA G40 EVO C1

CODICE	DESCRIZIONE	CF	M.V.	PREZZO
02051 0000	Ø 40	1	1	€ 18,00

## AERATORE PER MISCELATORE M 24

CODICE	DESCRIZIONE	CF	M.V.	PREZZO
02074 0000	--	10	10	€ 0,83



## AERATORE PER MISCELATORE F 22

CODICE	DESCRIZIONE	CF	M.V.	PREZZO
02072 0000	--	10	10	€ 0,83



## AERATORE PER MISCELATORE VASCA M 28

CODICE	DESCRIZIONE	CF	M.V.	PREZZO
02078 0000	--	10	10	€ 1,97



## AERATORE BIDET A SNODO

CODICE	DESCRIZIONE	CF	M.V.	PREZZO
02080 2400	maschio 24x1	1	1	€ 4,50
02080 2200	femmina 22x1	1	1	€ 4,50



## AERATORE BIDET A SNODO

CODICE	DESCRIZIONE	CF	M.V.	PREZZO
02082 1600	16 x 1	1	1	€ 7,32





## AERATORE PER MISCELATORE F16

CODICE	DESCRIZIONE	CF	M.V.	PREZZO
02076 0000	F16 x 1	10	10	€ 6,12



## AERATORE PER MISCELATORE PERLATOR 'LL' M24

CODICE	DESCRIZIONE	CF	M.V.	PREZZO
02075 0000	M24 x 1	10	10	€ 2,58



## AERATORE PER MISCELATORE PERLATOR 'LL' M22

CODICE	DESCRIZIONE	CF	M.V.	PREZZO
02073 0000	F22 x 1	10	10	€ 2,58



## CHIAVE IN PLASTICA PER AERATORI

CODICE	DESCRIZIONE	CF	M.V.	PREZZO
02071 0000	F22, M24, M28	10	1	€ 1,95

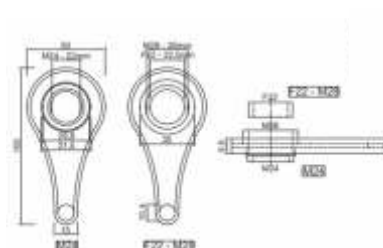

## RIDUZIONE PER AERATORE M24x22M

CODICE	DESCRIZIONE	CF	M.V.	PREZZO
02083 2422	F24 x 22M	10	10	€ 1,50



## RIDUZIONE PER AERATORE F22x1/2M

CODICE	DESCRIZIONE	CF	M.V.	PREZZO
02084 2204	F22 x 1/2M	10	10	€ 1,84



## RIDUZIONE PER AERATORE F22x3/4M

CODICE	DESCRIZIONE	CF	M.V.	PREZZO
02086 2205	F22 x 3/4M	10	10	€ 2,92



## RIDUZIONE PER AERATORE M24x3/4M

CODICE	DESCRIZIONE	CF	M.V.	PREZZO
02088 2405	M24 x 3/4M	10	10	€ 3,48



## RIDUZIONE PER AERATORE M24x1/2M

CODICE	DESCRIZIONE	CF	M.V.	PREZZO
02090 2404	M24 x 1/2M	10	10	€ 2,35





## AERATORE PROLUNGATO BIANCO

CODICE	DESCRIZIONE	CF	M.V.	PREZZO
02092 2200	F22 x 1	1	1	€ 3,70

- Con adattatore M22x1 x M24x1



## AERATORE PROLUNGATO CROMATO

CODICE	DESCRIZIONE	CF	M.V.	PREZZO
02094 2200	F22 x 1	1	1	€ 7,50

- Con adattatore M22x1 x M24x1



## AERATORE CON SNODO

CODICE	DESCRIZIONE	CF	M.V.	PREZZO
02096 2200	F22 x 1	1	1	€ 3,54

- Con adattatore M22x1 x M24x1



## DEVIATORE UNIVERSALE PER RUBINETTO

CODICE	DESCRIZIONE	CF	M.V.	PREZZO
00940 0000	F22 x 1	1	1	€ 19,10

- Completo di adattatore M22 x 1 e M24 x 1



## KIT FISSAGGIO PER MISCELATORI

CODICE	DESCRIZIONE	CF	M.V.	PREZZO
01711 0000	1 tirante	1	1	€ 1,70



## KIT FISSAGGIO PER MISCELATORI

CODICE	DESCRIZIONE	CF	M.V.	PREZZO
01712 0000	2 tiranti	1	1	€ 1,70



## GHIERA TROPPO PIENO LAVABO/BIDET

CODICE	DESCRIZIONE	CF	M.V.	PREZZO
00950 1400	DM 14	10	1	€ 0,98
00950 1900	DM 19	10	1	€ 0,98
00950 2400	DM 24	10	1	€ 1,10
00950 2800	DM 28	10	1	€ 1,10



## GHIERA TROPPO PIENO CIECA

CODICE	DESCRIZIONE	CF	M.V.	PREZZO
00952 0000	DM 35	1	1	€ 1,75



## C24 - FLESSIBILI



Made in Italy

### FLESSIBILE M $\frac{1}{2}$ x F $\frac{1}{2}$ passaggio totale

CODICE	DESCRIZIONE	CF	M.V.	PREZZO
02122 0025	DN13 CM 25	25	1	€ 6,62
02122 0030	DN13 CM 30	25	1	€ 7,07
02122 0035	DN13 CM 35	25	1	€ 7,62
02122 0040	DN13 CM 40	25	1	€ 8,14
02122 0050	DN13 CM 50	10	1	€ 9,53
02122 0060	DN13 CM 60	10	1	€ 10,37



Made in Italy

### FLESSIBILE antivibrante M $\frac{3}{4}$ x F $\frac{3}{4}$

CODICE	DESCRIZIONE	CF	M.V.	PREZZO
02168 0030	CM 30	5	1	€ 12,17
02168 0040	CM 40	5	1	€ 13,10
02168 0050	CM 50	5	1	€ 14,66
02168 0060	CM 60	5	1	€ 14,90



Made in Italy

### FLESSIBILE antivibrante M1" x F1"

CODICE	DESCRIZIONE	CF	M.V.	PREZZO
02110 0030	CM 30	5	1	€ 21,60
02110 0040	CM 40	5	1	€ 23,65
02110 0050	CM 50	5	1	€ 25,65
02110 0060	CM 60	5	1	€ 27,68
02110 0080	CM 80	5	1	€ 31,59



Made in Italy

### FLESSIBILE ANTI VIBRANTE M 1-1/4 x F 1-1/4

CODICE	DESCRIZIONE	CF	M.V.	PREZZO
02112 0030	cm 30	5	1	€ 44,32
02112 0040	cm 40	5	1	€ 46,58
02112 0050	cm 50	5	1	€ 49,06
02112 0060	cm 60	5	1	€ 51,92

## FLESSIBILE M3/8 X F3/8

CODICE	DESCRIZIONE	CF	M.V.	PREZZO
02134 0025	DN8 CM 25	10	1	€ 4,32
02134 0030	DN8 CM 30	10	1	€ 4,51
02134 0035	DN8 CM 35	10	1	€ 4,70
02134 0040	DN8 CM 40	10	1	€ 4,95



Made in Italy

## FLESSIBILE M1/2 X F3/8

CODICE	DESCRIZIONE	CF	M.V.	PREZZO
02119 0020	Dn8 CM 20	25	1	€ 4,26
02119 0025	DN8 CM 25	25	1	€ 4,37
02119 0030	DN8 CM 30	25	1	€ 4,59
02119 0035	DN8 CM 35	25	1	€ 4,63
02119 0040	DN8 CM 40	10	1	€ 4,86
02119 0050	DN8 CM 50	10	1	€ 5,17
02119 0060	DN8 CM 60	10	1	€ 5,29
02119 0100	DN8 CM 100	10	1	€ 7,56



Made in Italy

## FLESSIBILE M1/2 PROLUNGATO X F3/8

CODICE	DESCRIZIONE	CF	M.V.	PREZZO
02133 0025	DN8 CM 25	10	1	€ 5,25
02133 0030	DN8 CM 30	10	1	€ 5,37
02133 0035	DN8 CM 35	10	1	€ 5,50
02133 0040	DN8 CM 40	10	1	€ 5,65
02133 0050	DN8 CM 50	10	1	€ 6,18
02133 0060	DN8 CM 60	10	1	€ 6,39
02133 0080	DN8 CM 80	10	1	€ 8,05
02133 0100	DN8 CM 100	10	1	€ 8,80



Made in Italy

## FLESSIBILE M1/2 X F3/8 PASSAGGIO TOTALE

CODICE	DESCRIZIONE	CF	M.V.	PREZZO
02121 0025	DN13 CM 25	10	1	€ 5,26
02121 0030	DN13 CM 30	10	1	€ 5,51
02121 0035	DN13 CM 35	10	1	€ 6,05
02121 0040	DN13 CM 40	10	1	€ 6,31
02121 0050	DN13 CM 50	10	1	€ 6,84



Made in Italy

- Rubinetto lavatrice con leva lunga serie leggera.



## FLESSIBILE M $\frac{1}{2}$ X F $\frac{1}{2}$

CODICE	DESCRIZIONE	CF	M.V.	PREZZO
02111 0020	DN10 CM 20	25	1	€ 4,02
02111 0025	DN10 CM 25	25	1	€ 4,18
02111 0030	DN10 CM 30	25	1	€ 4,36
02111 0035	DN10 CM 35	25	1	€ 4,72
02111 0040	DN10 CM 40	25	1	€ 4,97
02111 0050	DN10 CM 50	25	1	€ 5,43
02111 0060	DN10 CM 60	10	1	€ 5,90
02111 0080	DN10 CM 80	10	1	€ 7,06
02111 0100	DN10 CM 100	10	1	€ 8,00



## FLESSIBILE M $\frac{1}{2}$ prolungato x F $\frac{1}{2}$

CODICE	DESCRIZIONE	CF	M.V.	PREZZO
02120 0020	DN10 CM 20	25	1	€ 5,35
02120 0025	DN10 CM 25	25	1	€ 5,79
02120 0030	DN10 CM 30	25	1	€ 6,04
02120 0035	DN10 CM 35	25	1	€ 6,31
02120 0040	DN10 CM 40	25	1	€ 6,72
02120 0050	DN10 CM 50	10	1	€ 7,08
02120 0060	DN10 CM 60	10	1	€ 7,55



## FLESSIBILE M $\frac{1}{2}$ prolungato + teflon x 3/8 bicono $\varnothing$ 10

CODICE	DESCRIZIONE	CF	M.V.	PREZZO
02135 0025	DN8 CM 25	10	1	€ 6,53
02135 0030	DN8 CM 30	10	1	€ 6,67
02135 0035	DN8 CM 35	10	1	€ 7,43
02135 0040	DN8 CM 40	10	1	€ 7,63
02135 0050	DN8 CM 50	10	1	€ 8,13



## FLESSIBILE 3/8 bicono $\varnothing$ 10 x F3/8

CODICE	DESCRIZIONE	CF	M.V.	PREZZO
02183 0025	DN10 CM 25	10	1	€ 6,48
02183 0030	DN10 CM 30	10	1	€ 6,64
02183 0040	DN10 CM 40	10	1	€ 6,85
02183 0050	DN10 CM 50	10	1	€ 7,24

## FLESSIBILE F3/8 x F3/8

CODICE	DESCRIZIONE	CF	M.V.	PREZZO
02114 0020	DN8 CM 20	25	1	€ 3,69
02114 0025	DN8 CM 25	25	1	€ 3,96
02114 0030	DN8 CM 30	25	1	€ 4,16
02114 0035	DN8 CM 35	10	1	€ 4,50
02114 0040	DN8 CM 40	10	1	€ 4,62
02114 0050	DN8 CM 50	10	1	€ 4,97



Made in Italy

## FLESSIBILE F1/2 x F3/8

CODICE	DESCRIZIONE	CF	M.V.	PREZZO
02115 0030	DN8 CM 30	10	1	€ 4,68
02115 0035	DN8 CM 35	10	1	€ 4,89
02115 0040	DN8 CM 40	10	1	€ 5,02



Made in Italy

## FLESSIBILE F1/2 x F1/2

CODICE	DESCRIZIONE	CF	M.V.	PREZZO
02116 0025	Dn8 CM 25	10	1	€ 4,57
02116 0030	DN8 CM 30	10	1	€ 4,57
02116 0035	DN8 CM 35	10	1	€ 5,04
02116 0040	DN8 CM 40	10	1	€ 5,04
02116 0050	DN8 CM 50	10	1	€ 5,68
02116 0060	DN8 CM 60	10	1	€ 6,35



Made in Italy



## FLESSIBILE M10 x 1 x F3/8"

CODICE	DESCRIZIONE	CF	M.V.	PREZZO
02132 0025	DN6 CM 25	10	1	€ 3,65
02132 0030	DN6 CM 30	10	1	€ 3,91
02132 0035	DN6 CM 35	10	1	€ 4,10
02132 0040	DN6 CM 40	10	1	€ 4,32
02132 0050	DN6 CM 50	10	1	€ 4,83
02132 0060	DN6 CM 60	10	1	€ 5,28



## FLESSIBILE M10 x 1 prolungato x F3/8"

CODICE	DESCRIZIONE	CF	M.V.	PREZZO
02125 0030	DN6 CM 30	10	1	€ 4,80
02125 0035	DN6 CM 35	10	1	€ 5,25
02125 0040	DN6 CM 40	10	1	€ 5,40
02125 0050	DN6 CM 50	10	1	€ 5,70



## FLESSIBILE M10 x 1 x F1/2"

CODICE	DESCRIZIONE	CF	M.V.	PREZZO
02123 0025	DN6 CM 25	10	1	€ 3,96
02123 0030	DN6 CM 30	10	1	€ 4,26
02123 0035	DN6 CM 35	10	1	€ 4,51
02123 0040	DN6 CM 40	10	1	€ 4,80
02123 0050	DN6 CM 50	10	1	€ 5,34

## RUBINETTO LAVATRICE CON LEVA LUNGA SERIE LEGGERA

CODICE	DESCRIZIONE	CF	M.V.	PREZZO
02201 0000	½ x 3/4	10	1	€ 7,90



## RUBINETTO LAVATRICE CON LEVA LUNGA IN METALLO

CODICE	DESCRIZIONE	CF	M.V.	PREZZO
02200 0000	½ x 3/4	25	1	€ 9,90



## RUBINETTO LAVATRICE CON LEVETTA SERIE LEGGERA

CODICE	DESCRIZIONE	CF	M.V.	PREZZO
02203 0000	½ x 3/4	10	1	€ 6,75



## RUBINETTO LAVATRICE CON LEVETTA SERIE COMPACT

CODICE	DESCRIZIONE	CF	M.V.	PREZZO
02202 0000	½ x 3/4	20	1	€ 8,75



## C25 - RUBINETTI LAVATRICE



### RUBINETTO LAVATRICE COMBINATO CON VITONE

CODICE	DESCRIZIONE	CF	M.V.	PREZZO
02208 0000	1/2 x 3/4	1	1	€ 21,60



### RUBINETTO LAVATRICE DUPLEX

CODICE	DESCRIZIONE	CF	M.V.	PREZZO
02210 0000	1/2 x 3/4	10	1	€ 17,90



### RUBINETTO LAVATRICE DUPLEX TIPO PESANTE

CODICE	DESCRIZIONE	CF	M.V.	PREZZO
02212 0000	1/2	20	1	€ 36,80



### RUBINETTO A VITONE PER LAVATRICE + LAVASTOVIGLIE

CODICE	DESCRIZIONE	CF	M.V.	PREZZO
02214 0000	1/2 x 3/4 x 3/4	6	1	€ 21,75

- Ottone cromato



## RUBINETTO A VITONE PER LAVATRICE

CODICE	DESCRIZIONE	CF	M.V.	PREZZO
02216 0000	Cromato	25	1	€ 9,72



## RACCORDO 3 VIE M/F/F

CODICE	DESCRIZIONE	CF	M.V.	PREZZO
04031 0000	1/2 x 1/2 x 1/2	10	1	€ 8,90

- In ottone lucido cromato



## RUBINETTO LAVATRICE RETROGRUPPO

CODICE	DESCRIZIONE	CF	M.V.	PREZZO
02218 0000	3/4	10	1	€ 14,25

- Inclusa prolunga distanziale.



## RUBINETTO LAVATRICE RETROGRUPPO CON CODOLO

CODICE	DESCRIZIONE	CF	M.V.	PREZZO
02219 0000	3/4	10	1	€ 15,30



## C26 - RUBINETTI FILTRO



### RUBINETTO FILTRO SNODO A SFERA

CODICE	DESCRIZIONE	CF	M.V.	PREZZO
02302 0000	1/2 x 3/8 x Ø 10	20	1	€ 9,45



### RUBINETTO FILTRO SNODO A VITONE

CODICE	DESCRIZIONE	CF	M.V.	PREZZO
02304 0000	1/2 x 3/8 x Ø 10	20	1	€ 11,25



### RUBINETTO FILTRO SENZA SNODO A VITONE

CODICE	DESCRIZIONE	CF	M.V.	PREZZO
02305 0000	1/2	10	1	€ 8,97



### RUBINETTO SOTTOLAVABO TONDO C/FILTRO

CODICE	DESCRIZIONE	CF	M.V.	PREZZO
02308 0000	1/2 x 3/8	1	1	€ 34,20



### RUBINETTO SOTTOLAVABO QUADRO C/FILTRO

CODICE	DESCRIZIONE	CF	M.V.	PREZZO
02309 0000	1/2 x 3/8	1	1	€ 67,80

# C27 - TUBO RAME CROMATO E ACCESSORI

## RUBINETTO PER CASSETTA WC

CODICE	DESCRIZIONE	CF	M.V.	PREZZO
02310 0000	1/2 x 3/8	1	1	€ 6,30



## TUBO RAME CROMATO Ø 10

CODICE	DESCRIZIONE	CF	M.V.	PREZZO
02320 0000	Ø 10	5	5	€ 15,90

- Prezzo riferito al metro.



## NIPPLES PER CANNETTE CROMATO

CODICE	DESCRIZIONE	CF	M.V.	PREZZO
02322 0300	F 3/8 x 10	10	1	€ 3,30
02322 0400	F 1/2 x 10	10	1	€ 3,30
02322 0301	M 3/8 x 10	10	1	€ 3,30
02322 0401	M 1/2 x 10	10	1	€ 3,90



## CURVETTA SOTTOLAVABO CROMATA

CODICE	DESCRIZIONE	CF	M.V.	PREZZO
02324 0000	½ x 10 mm	1	1	€ 6,25



# C27 - CANNUCCE RAME CROMATO



**New**

## TUBO RAME CROMATO C/CARTELLA E CALOTTA

CODICE	DESCRIZIONE	CF	M.V.	PREZZO
02410 0030	1/2 x CM 30	25	1	€ 6,60
02410 0040	1/2 x CM 40	25	1	€ 7,35
02410 0050	1/2 x CM 50	25	1	€ 8,20
02410 0060	1/2 x CM 60	25	1	€ 8,90

- DM 10



**New**

## TUBO RAME CROMATO 3/8 M

CODICE	DESCRIZIONE	CF	M.V.	PREZZO
02412 0030	CM 30	25	1	€ 7,60
02412 0040	CM 40	25	1	€ 9,30
02412 0050	CM 50	25	1	€ 10,10

- DM 10



## CANNUCCIA 1/4

CODICE	DESCRIZIONE	CF	M.V.	PREZZO
02138 0035	--	10	1	€ 5,00
02138 0040	--	10	1	€ 5,00



**New**

## TUBO RAME CROMATO IN BARRE

CODICE	DESCRIZIONE	CF	M.V.	PREZZO
02321 0000	∅ 10 x 1 mt	1	1	€ 15,90

SISTEMI  
DI  
SCARICO

*La misura dell'intelligenza  
è data dalla capacità di cambiare  
quando è necessario.*

*Albert Einstein*





**P**ILETTE

**S**IFONI

**R**OSETTE

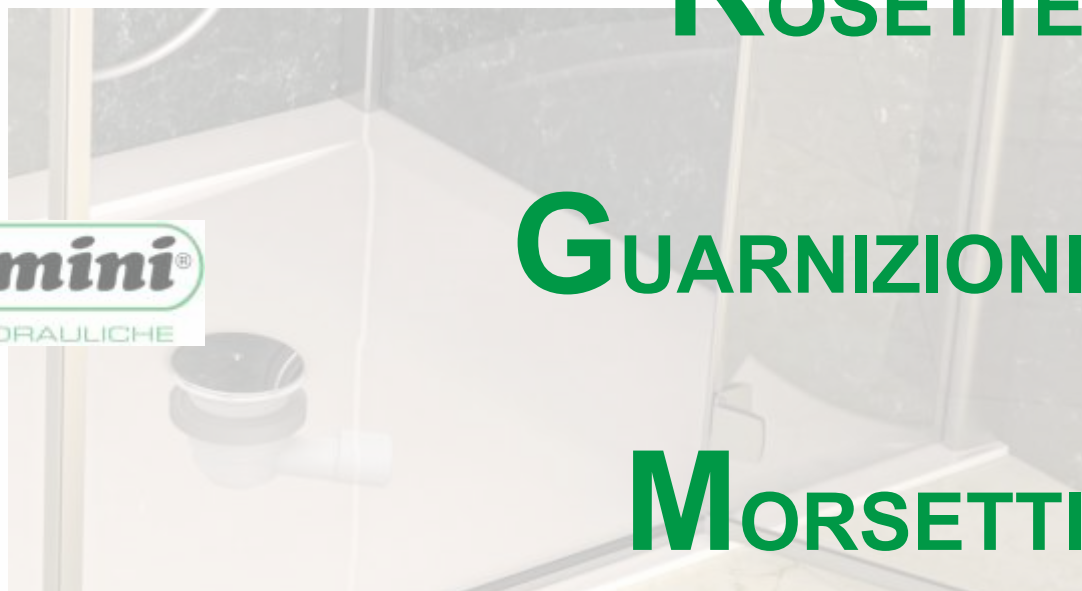

**G**UARNIZIONI

**M**ORSETTI



**A**CCESSORI **V**ASCA

**S**CARICO **L**AVATRICE

**CGS**

## PILETTA LAVABO SCARICO NORTON

CODICE	DESCRIZIONE	CF	M.V.	PREZZO
02600 0600	1"	1	1	€ 10,88
02600 0700	1 - 1/4"	1	1	€ 9,58



## TAPPO PER SALTARELLO

CODICE	DESCRIZIONE	CF	M.V.	PREZZO
02602 0600	PVC 1"	10	1	€ 1,87
02602 0700	PVC 1 - 1/4"	10	1	€ 2,45



## SNODO DOPPIO IN OTTONE

CODICE	DESCRIZIONE	CF	M.V.	PREZZO
02604 0000	Ottone	10	10	€ 2,00



## KIT ASTA SALTARELLO

CODICE	DESCRIZIONE	CF	M.V.	PREZZO
02606 0000	Kit asta per saltarello	10	1	€ 2,50



# D1 - PILETTE PER SANITARI



## PILETTA LAVABO CON TROPPO PIENO

CODICE	DESCRIZIONE	CF	M.V.	PREZZO
02610 0670	1" x 63x70	10	1	€ 11,00
02610 0770	1-1/4 x 63x70	10	1	€ 12,00



## PILETTA LAVABO SENZA TROPPO PIENO

CODICE	DESCRIZIONE	CF	M.V.	PREZZO
02612 0670	1" x 63x70	10	1	€ 11,10
02612 0770	1-1/4 x 63x70	10	1	€ 12,48



**New**

## TAPPO GOMMA PER LAVELLO CON MANIGLIA

CODICE	DESCRIZIONE	CF	M.V.	PREZZO
02614 4547	Ø 45-47	100	1	€ 1,25

- Adattabile in ogni tipo di pileta con troppo pieno.



**New**

## TAPPO GOMMA NERO PER LAVELLO CON CATENELLA

CODICE	DESCRIZIONE	CF	M.V.	PREZZO
02614 0052	Ø 52	100	1	€ 2,35

- Catenella lunga 250 mm.

## PILETTA PER LAVABO CON TAPPO A SCATTO STP

CODICE	DESCRIZIONE	CF	M.V.	PREZZO
02620 0000	1-1/4	1	1	€ 20,83

- Utilizzabile anche per lavandino con troppo pieno.



## PILETTA PER LAVABO CLICK-CLACK NERA

CODICE	DESCRIZIONE	CF	M.V.	PREZZO
02622 0000	1 - 1/4	1	1	€ 27,60



## PILETTA PER LAVABO CLICK-CLACK BIANCA

CODICE	DESCRIZIONE	CF	M.V.	PREZZO
02624 0000	1 - 1/4	1	1	€ 27,60

- Bianco opaco.



## TAPPO COPRIFORO

CODICE	DESCRIZIONE	CF	M.V.	PREZZO
02630 0000	diámetro 50 - CROMO	20	1	€ 2,25



## TAPPO COPRIFORO BIANCO

CODICE	DESCRIZIONE	CF	M.V.	PREZZO
02631 0000	DM 50	20	1	€ 2,93

- Ottone smaltato bianco



# D1 - PILETTE PER SANITARI



## TAPPARELLO A SCATTO DM 1"

CODICE	DESCRIZIONE	CF	M.V.	PREZZO
02616 0000	1"	1	1	€ 5,90

- Adattabile in ogni tipo di pileta con troppo pieno.



## TAPPARELLO UNIVERSALE CLICK-CLACK

CODICE	DESCRIZIONE	CF	M.V.	PREZZO
02618 0000	1 - 1/4	1	1	€ 14,00



## TAPPO SCATTINO A GRIGLIA

CODICE	DESCRIZIONE	CF	M.V.	PREZZO
02648 0000	Diametro 50	18	1	€ 5,72

- Chiusura a scatto



## GRIGLIA PER LAVELLO INOX

CODICE	DESCRIZIONE	CF	M.V.	PREZZO
02649 0000	pomello in plastica	10	1	€ 5,19



## PILETTONE PER LAVELLO INOX mm 90

CODICE	DESCRIZIONE	CF	M.V.	PREZZO
02640 0000	Diametro 90 x 1-1/2	1	1	€ 25,80

- Fino ad esaurimento.



## PILETTONE PER LAVELLO INOX C/TROPPO PIENO

CODICE	DESCRIZIONE	CF	M.V.	PREZZO
02642 0001	Diametro 90 x 1-1/2	1	1	€ 30,00

- Tappo ad espansione.

- Fino ad esaurimento.



## PILETTONE PER LAVELLO INOX C/TROPPO PIENO TONDO

CODICE	DESCRIZIONE	RIF. F.	CF	M.V.	PREZZO
02643 0000	Ø 90 x 1-1/2	1975Lx64B0	1	1	€ 24,90

- Tappo ad espansione.

- Fino ad esaurimento.





## PILETTONE PER LAVELLO INOX mm 90

CODICE	DESCRIZIONE	CF	M.V.	PREZZO
02644 0000	Diametro 90 x 1-1/2	1	1	€ 8,90

- Chiusura ad espansione



## PILETTONE PER LAVELLO INOX C/TROPPO PIENO

CODICE	DESCRIZIONE	CF	M.V.	PREZZO
02646 0000	Diametro 90 x 1-1/2	1	1	€ 11,97

- Chiusura ad espansione



## PILETTONE PER LAVELLO INOX C/TROPPO PIENO TONDO

CODICE	DESCRIZIONE	CF	M.V.	PREZZO
02647 0000	Ø 90 x 1-1/2	1	1	€ 12,92



## GRIGLIA PER LAVELLO INOX

CODICE	DESCRIZIONE	CF	M.V.	PREZZO
02661 0000	Ø 60	50	10	€ 1,05

## PILETTA IN PVC PER LAVELLI CERAMICA

CODICE	DESCRIZIONE	CF	M.V.	PREZZO
02650 0880	1 - ½ x 80	1	1	€ 5,64
02650 0780	1 - 1/4 x 80	1	1	€ 5,64



## PILETTA IN PVC PER LAVELLI INOX

CODICE	DESCRIZIONE	CF	M.V.	PREZZO
02652 0000	1 - ½	1	1	€ 4,40



## PILETTA IN PVC PER LAVELLI INOX C/TROPPO PIENO

CODICE	DESCRIZIONE	CF	M.V.	PREZZO
02654 0000	1 - ½	1	1	€ 9,88



## PILETTA IN PVC PER LAVELLI INOX C/TROPPO PIENO

CODICE	DESCRIZIONE	CF	M.V.	PREZZO
02656 0000	1 - ½ c/troppo pieno tondo	1	1	€ 10,10





[BONOMINI.COM](http://BONOMINI.COM)

TECNOLOGIE IDRAULICHE

Dal 1984 Bonomini S.r.l. è specializzata nella produzione di sifoni e pilette per il drenaggio dell'acqua. L'azienda è attualmente in forte espansione nel mercato europeo, asiatico e africano: la gamma offerta è una delle più ampie prodotte in Italia, con un assortimento che include più di 100 referenze.

## VITE PER PILETTE MOPLÉN

CODICE	DESCRIZIONE	CF	M.V.	PREZZO
02660 0000	---	10	1	€ 3,50



## VITE ACCIAIO PER PILETTE IN MOPLÉN

CODICE	DESCRIZIONE	CF	M.V.	PREZZO
02662 0070	M 6 x 70 MM	10	1	€ 1,61
02662 0100	M 6 x 100 MM	10	1	€ 5,49



## TAPPO C/ROSETTA

CODICE	DESCRIZIONE	CF	M.V.	PREZZO
02848 0000	1/2	50	1	€ 2,20





## SIFONE MOPLEN 1 VIA

CODICE	DESCRIZIONE	CF	M.V.	PREZZO
02701 0732	1 1/4 x 32	1	1	€ 5,25
02701 0840	1 1/2 x 40	1	1	€ 5,36



## SIFONE MOPLEN 2 VIA

CODICE	DESCRIZIONE	CF	M.V.	PREZZO
02702 0732	1 - 1/4 x 32	1	1	€ 7,17
02702 0840	1 - 1/2 x 40	1	1	€ 9,15



## SIFONE MAGNUM 1 VIA

CODICE	DESCRIZIONE	CF	M.V.	PREZZO
02704 0000	1 - 1/2 x 40	1	1	€ 6,32



## SIFONE MAGNUM 2 VIE

CODICE	DESCRIZIONE	CF	M.V.	PREZZO
02706 0000	1 - 1/2 x 40	1	1	€ 10,39



## SIFONE MOPLEN SALVASPAZIO

CODICE	DESCRIZIONE	CF	M.V.	PREZZO
02711 0000	1 via - 1 - ½	1	1	€ 10,60



## SIFONE MOPLEN SALVASPAZIO

CODICE	DESCRIZIONE	CF	M.V.	PREZZO
02712 0000	2 vie - 1 - ½	1	1	€ 18,75



## SIFONE Q GIREVOLE Ø 50

CODICE	DESCRIZIONE	CF	M.V.	PREZZO
02716 0000	Ø 50	1	1	€ 6,70

- Ideale per sotto lavello con cassettone scorrevole.



## PROLUNGA SIFONE CON ATTACCO DOPPIO

CODICE	DESCRIZIONE	CF	M.V.	PREZZO
02723 0840	1 - ½ x 40	1	1	€ 3,75



## D3 - ACCESSORI PER SIFONI MOPLEN



### ATTACCO LAVATRICE UNIVERSALE

CODICE	DESCRIZIONE	CF	M.V.	PREZZO
02718 0732	1-1/4 x Ø 32 mm	1	1	€ 2,97
02718 0840	1-1/2 x Ø 40 mm	1	1	€ 3,69

- Con guarnizione conica.



### ATTACCO LAVATRICE FLANGIATO

CODICE	DESCRIZIONE	CF	M.V.	PREZZO
02720 0707	F 1-1/4 x m 1-1/4	1	1	€ 4,94
02720 0808	F 1-1/2 x m 1-1/2	1	1	€ 4,35

- Con guarnizione piana.



### PROLUNGA SIFONE CON ATTACCO LAVATRICE

CODICE	DESCRIZIONE	CF	M.V.	PREZZO
02722 0732	1-1/4 x 32 x 200 mm	1	1	€ 6,00
02722 0840	1-1/2 x 40 mm	1	1	€ 6,00



### PROLUNGA SIFONE FLANGIATA

CODICE	DESCRIZIONE	CF	M.V.	PREZZO
02724 0732	1-1/4 x 32 x 200 mm	1	1	€ 4,26
02724 0840	1-1/2 x 40 x 200 mm	1	1	€ 4,43



### PROLUNGA DI SCARICO UNIVERSALE

CODICE	DESCRIZIONE	RIF. F.	CF	M.V.	PREZZO
02726 0732	1-1/4 x 32	1820NN54BO	5	1	€ 3,70
02726 0840	1-1/2 x 40	1820NN64BO	5	1	€ 4,30

## TUBO SCARICO COMPATTABILE CON SPIRALE METALLICA

CODICE	DESCRIZIONE	CF	M.V.	PREZZO
02740 0600	1"	1	1	€ 9,31
02740 0700	1-1/4	1	1	€ 9,31
02740 0800	1-1/2	1	1	€ 10,40



## TUBO JOLLYFLEX

CODICE	DESCRIZIONE	CF	MT	PREZZO
02742 0032	Diametro 32 - Interno diametro 25	20	20	€ 3,57
02742 0040	Diametro 40 - Interno diametro 32	20	20	€ 3,85



## MANICOTTO PER JOLLYFLEX

CODICE	DESCRIZIONE	CF	M.V.	PREZZO
02744 3232	Diametro 32 per Tubo 32	50	1	€ 1,08
02744 4040	Diametro 40 per Tubo 40	50	1	€ 1,08



## MANICOTTO C/DADO PER TUBO JOLLYFLEX

CODICE	DESCRIZIONE	CF	M.V.	PREZZO
02746 0632	F 1" per Tubo diametro 32	1	1	€ 2,63
02746 0732	F 1" 1/4 per Tubo diametro 32	1	1	€ 2,63
02746 0840	F 1" 1/2 per Tubo diametro 40	1	1	€ 2,63



# D4 - SIFONI FLESSIBILI



## SIFONE ALLUNGABILE CON GHIERA IN OTTONE

CODICE	DESCRIZIONE	CF	M.V.	PREZZO
02750 0626	1" x 32	200	1	€ 3,38
02750 0732	1" 1/4 x 32	150	1	€ 2,48
02750 0740	1" 1/4 x 32-40	150	1	€ 2,48
02750 0840	1" 1/2 x 40 - 50	150	1	€ 2,48



## SIFONE CON DOPPIO FLESSIBILE

CODICE	DESCRIZIONE	CF	M.V.	PREZZO
02752 0000	1 - 1/2 x 40/50	1	1	€ 5,48

- Con ghibre in metallo



## SIFONE MAGIKONE CON ATTACCO CURVO

CODICE	DESCRIZIONE	CF	M.V.	PREZZO
02754 0732	1 - 1/4 x 32/40	1	1	€ 6,59
02754 0840	1 - 1/2 x 40/50	1	1	€ 7,24



## RIDUZIONE PP

CODICE	DESCRIZIONE	CF	M.V.	PREZZO
02756 0706	F 1-1/4 x M 1"	1	1	€ 0,55
02756 0807	F 1-1/2 x M 1-1/4	1	1	€ 0,55



## RIDUZIONE PP

CODICE	DESCRIZIONE	CF	M.V.	PREZZO
02758 0706	M 1-1/4 x F 1"	1	1	€ 0,55
02758 0807	M 1-1/2 x F 1-1/4	1	1	€ 0,55

## SIFONE FLESSIBILE CROMATO

CODICE	DESCRIZIONE	CF	M.V.	PREZZO
02760 0632	1" x 32	1	1	€ 9,79
02760 0732	1-1/4 x 32/40	1	1	€ 9,79
02760 0840	1-1/2 x 40	1	1	€ 9,79



## SIFONE ESTENSIBILE IN ACCIAIO INOX

CODICE	DESCRIZIONE	CF	M.V.	PREZZO
02762 0000	1 - 1/4 x 32	20	20	€ 17,90

- Tubo maggiorato diametro 40
- Estensibile da 300 a 450 mm

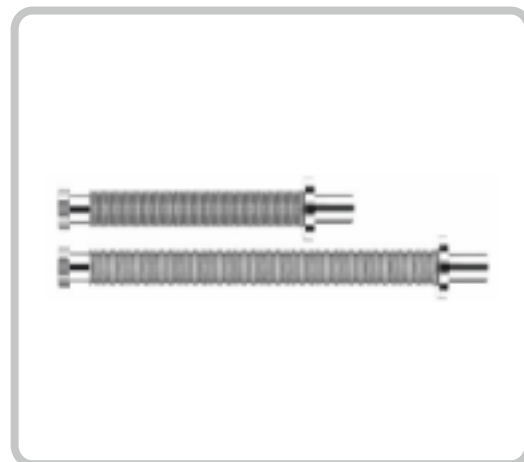

## RIDUZIONE OTTONE CROMATO FM

CODICE	DESCRIZIONE	CF	M.V.	PREZZO
02766 0706	1-1/4 x 1"	10	1	€ 4,75
02766 0807	1-1/2 x 1-1/4	10	1	€ 4,75





## SIFONE ABS CROMATO AD ESSE

CODICE	DESCRIZIONE	CF	M.V.	PREZZO
02800 0626	1" x 26	15	1	€ 22,66
02800 0732	1 - 1/4 x 32	15	1	€ 24,68



## SIFONE ABS ARREDO TONDO BIANCO OPACO

CODICE	DESCRIZIONE	CF	M.V.	PREZZO
02816 0000	1 - 1/4 x 32	1	1	€ 40,80

- Realizzati in ABS.
- Facilmente ispezionabile dal basso.



## SIFONE ABS ARREDO TONDO NERO OPACO

CODICE	DESCRIZIONE	CF	M.V.	PREZZO
02818 0000	1 - 1/4 x 32	1	1	€ 42,80

- Realizzati in ABS.
- Facilmente ispezionabile dal basso.



## VALVOLA IMMISSIONE ARIA AIRPIPE

CODICE	DESCRIZIONE	CF	M.V.	PREZZO
02728 0000	1 - 1/4 x 40	25	1	€ 14,00

- Bianca.
- Grazie alla particolare valvola meccanica, neutralizza le depressioni dell'impianto di scarico, immettendo aria ed evitando lo svuotamento del sifone e il conseguente cattivo odore.



## SIFONE OTTONE ARREDO QUADRO CROMATO

CODICE	DESCRIZIONE	CF	M.V.	PREZZO
02810 0000	1 - 1/4	1	1	€ 58,20

- Corpo in zama.
- Canotti in acciaio.



## SIFONE OTTONE ARREDO TONDO CROMATO

CODICE	DESCRIZIONE	CF	M.V.	PREZZO
02812 0000	1 - 1/4	1	1	€ 53,50



## SIFONE OTTONE ARREDO TONDO NERO

CODICE	DESCRIZIONE	CF	M.V.	PREZZO
02814 0000	1 - 1/4	1	1	€ 62,25





## SIFONE OTTONE CROMATO A ESSE

CODICE	DESCRIZIONE	CF	M.V.	PREZZO
02820 2606	diametro 26 x 250 1"	20	1	€ 18,49
02820 3207	diametro 32 x 250 1 - 1/4"	20	1	€ 19,00



## SIFONE OTTONE CROMATO AD ESSE

CODICE	DESCRIZIONE	CF	M.V.	PREZZO
02821 3207	Ø 32 x 250 1-1/4	10	1	€ 19,75



## SIFONE OTTONE CROMATO A BOTTIGLIA

CODICE	DESCRIZIONE	CF	M.V.	PREZZO
02822 2606	diametro 26 x 250 1"	1	1	€ 17,25
02822 3207	diametro 32 x 250 1 - 1/4"	1	1	€ 20,05



## CANOTTO FLESSIBILE CROMATO

CODICE	DESCRIZIONE	CF	M.V.	PREZZO
02833 3230	DM 32 x CM 30	10	1	€ 10,00

## CANOTTO CON BATTENTE

CODICE	DESCRIZIONE	CF	M.V.	PREZZO
02830 2630	diametro 26 x cm 30	10	10	€ 5,40
02830 3030	diametro 30 x cm 30	10	10	€ 6,19
02830 3230	diametro 32 x cm 30	10	10	€ 6,19



## CANOTTO LISCIO SENZA ORLO

CODICE	DESCRIZIONE	CF	M.V.	PREZZO
02832 2630	26 x 300	1	1	€ 4,58
02832 3230	32 x 300	1	1	€ 6,10



## MANICOTTO CROMATO PER CANOTTO

CODICE	DESCRIZIONE	CF	M.V.	PREZZO
02834 0026	Ø 26	10	1	€ 5,10
02834 0032	Ø 32	10	1	€ 6,10

- Con o-ring di tenuta.



## MANICOTTO RIDOTTO CROMATO PER CANOTTO

CODICE	DESCRIZIONE	CF	M.V.	PREZZO
02835 0000	26 - 32	10	1	€ 7,10

- Con o-ring di tenuta.





## ROSETTA IN OTTONE CROMATO

CODICE	DESCRIZIONE	CF	M.V.	PREZZO
02840 0460	1/2 Diametro 60	100	1	€ 1,03
02840 0472	1/2 Diametro 72	100	1	€ 1,75
02840 0572	3/4 Diametro 72	100	1	€ 2,26
02840 0672	1" Diametro 72	100	1	€ 2,26



## ROSETTA IN OTTONE GIALLO

CODICE	DESCRIZIONE	CF	M.V.	PREZZO
02841 0460	1/2 Diametro 60	10	1	€ 2,50



## ROSONE IN OTTONE CROMATO PER CANOTTI

CODICE	DESCRIZIONE	CF	M.V.	PREZZO
02842 2600	Diametro 26	10	1	€ 1,57
02842 3000	Diametro 30	10	1	€ 1,57
02842 3200	Diametro 32	10	1	€ 1,85

- Diametro esterno 76 mm



## ROSONE CATIS CON FORO OVALE

CODICE	DESCRIZIONE	CF	M.V.	PREZZO
02846 0078	DM 78	1	1	€ 2,38
02846 0112	DM 112	1	1	€ 7,00

## GUARNIZIONI CONICHE

CODICE	DESCRIZIONE	CF	M.V.	PREZZO
02900 0600	1" 30x26x7 PVC	100	10	€ 0,20
02900 0700	1-1/4 37x32x7 PVC	100	10	€ 0,25
02900 0800	1-1/2 45x40x7 PVC	100	10	€ 0,28
02900 4050	40-50 gomma	50	10	€ 0,56



## GUARNIZIONE IN GOMMA TELATA

CODICE	DESCRIZIONE	CF	M.V.	PREZZO
02902 0300	3/8	100	100	€ 0,08
02902 0400	1/2	100	100	€ 0,08
02902 0401	1/2 x GAS	100	100	€ 0,16
02902 0500	3/4	100	100	€ 0,10
02902 0501	3/4 per Lavatrice	100	100	€ 0,10
02902 0600	1"	100	100	€ 0,15
02902 0700	1" 1/4	100	100	€ 0,18
02902 0800	1" 1/2	100	100	€ 0,19
02902 0900	2"	100	100	€ 0,27



## GUARNIZIONE GOMMA CON RETINA

CODICE	DESCRIZIONE	CF	M.V.	PREZZO
02904 0300	3/8	10	1	€ 0,81
02904 0400	1/2 (fless. doccia)	10	1	€ 0,58
02904 0500	3/4 (lavatrice)	10	1	€ 1,18



## GUARNIZIONE ESENTE AMIANTO

CODICE	DESCRIZIONE	CF	M.V.	PREZZO
02906 0200	1/4	100	100	€ 0,12
02906 0300	3/8	100	100	€ 0,04
02906 0400	1/2	100	100	€ 0,05
02906 0500	3/4	100	100	€ 0,06
02906 0600	1"	100	100	€ 0,07
02906 0700	1" 1/4	100	100	€ 0,12
02906 0800	1" 1/2	100	100	€ 0,18
02906 0900	2"	100	100	€ 0,32



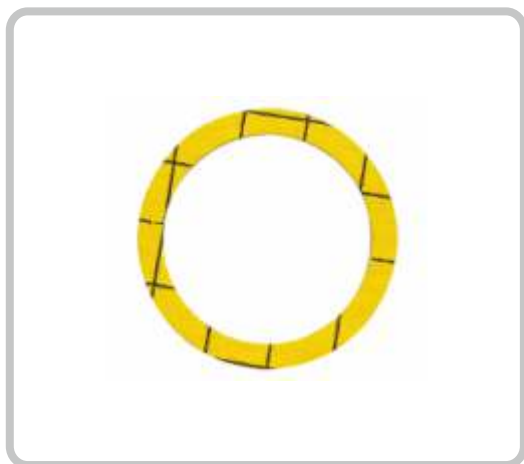

## GUARNIZIONE GOLD SOFT

CODICE	DESCRIZIONE	CF	M.V.	PREZZO
02907 0400	1/2	100	100	€ 0,15
02907 0500	3/4	100	100	€ 0,22
02907 0600	1"	100	100	€ 0,25

- Elevata elasticità
- Superiore resistenza termomeccanica
- Adatta anche per oli e carburante



## GUARNIZIONE ALLUMINIO

CODICE	DESCRIZIONE	CF	M.V.	PREZZO
02908 0400	1/2	100	10	€ 0,13
02908 0500	3/4	100	10	€ 0,30



## GUARNIZIONE B-POWER

CODICE	DESCRIZIONE	CF	M.V.	PREZZO
02910 0600	1"	100	1	€ 0,64
02910 0700	1" 1/4	100	1	€ 0,64
02910 0800	1" 1/2	50	1	€ 0,70



## GUARNIZIONE RICAMBIO FORATA PER VITONE

CODICE	DESCRIZIONE	CF	M.V.	PREZZO
00933 0003	3/8	100	10	€ 0,13
00933 0004	1/2	100	10	€ 0,13
00933 0005	3/4	100	10	€ 0,17
00933 0006	1"	100	10	€ 0,22

## "OR" DI RICAMBIO PER CANNE RUBINETTO

CODICE	DESCRIZIONE	CF	M.V.	PREZZO
02026 1210	12.10 x 2.70	100	100	€ 0,10
02026 1360	13.60 x 2.70	100	100	€ 0,10

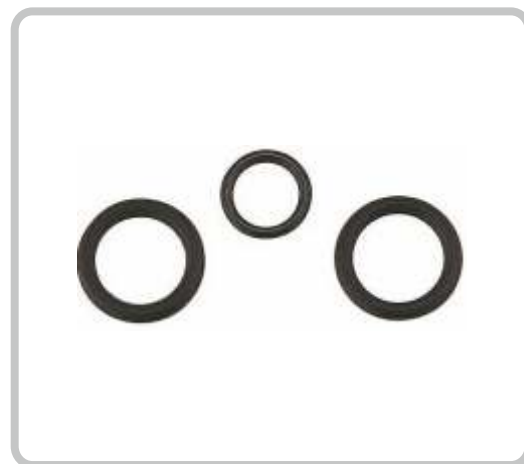

## ANELLI O-RING

CODICE	DESCRIZIONE	CF	M.V.	PREZZO
02927 0340	3,4 x 1,9	100	100	€ 3,50
02927 0420	4,2 x 1,9	100	100	€ 3,50
02927 0640	6,4 x 1,9	100	100	€ 3,50
02927 0890	8,9 x 2,7*	100	100	€ 4,90
02927 0992	9,92 x 2,62*	100	100	€ 6,90
02927 1050	10,5 x 2,7*	100	100	€ 7,30
02927 1510	15,1 x 2,7	100	100	€ 8,60
02927 1830	18,3 x 3,6	100	100	€ 10,40
02927 2130	21,3 x 3,6	100	100	€ 11,25
02927 2460	24,6 x 3,6	100	100	€ 14,00
02927 2930	29,3 x 3,6	100	100	€ 15,50
02927 3560	35,6 x 3,6	100	100	€ 20,40

\* per canne lavello.



## GUARNIZIONE A CAPPELLO PER GALLEGGIANTI

CODICE	DESCRIZIONE	CF	M.V.	PREZZO
04716 0019	19 mm	100	1	€ 0,60
04716 0021	21 mm	100	1	€ 0,66
04716 0024	24 mm	100	1	€ 0,66



## MEMBRANA DI CHIUSURA PER GALLEGGIANTE CATIS

CODICE	DESCRIZIONE	CF	M.V.	PREZZO
04718 0000	--	25	1	€ 0,40





## GUARNIZIONE CONICA BORDO ALTO

CODICE	DESCRIZIONE	CF	M.V.	PREZZO
02920 0400	1/2	10	1	€ 0,56
02920 0500	3/4	10	1	€ 0,62
02920 0600	1"	10	1	€ 0,66
02920 0700	1 - 1/4	10	1	€ 0,82
02920 0800	1 - 1/2	10	1	€ 0,88



## GUARNIZIONE CONICA BORDO BASSO

CODICE	DESCRIZIONE	CF	M.V.	PREZZO
02922 0400	1/2	10	1	€ 0,45
02922 0500	3/4	10	1	€ 0,70
02922 0600	1"	10	1	€ 0,75
02922 0700	1 - 1/4	10	1	€ 0,88
02922 0800	1 - 1/2	10	1	€ 1,03



## MORSETTO PER CASSETTA INCASSO

CODICE	DESCRIZIONE	CF	M.V.	PREZZO
02952 5540	55 x 40	1	1	€ 1,42



## REGOLATORE DI FLUSSO CON GUARNIZIONE

CODICE	DESCRIZIONE	CF	M.V.	PREZZO
02954 0000	DM 50	--	--	€ 6,25

- Ideale per sanitari di nuova generazione, ove necessitano flussi d'acqua ridotti.

## MORSETTO IN GOMMA NERA

CODICE	DESCRIZIONE	CF	M.V.	PREZZO
02940 3226	DM 32 x diametro 26	50	1	€ 0,57
02940 4026	DM 40 x diametro 26/32	50	1	€ 0,57
02940 5026	DM 50 x diametro 26/32	50	1	€ 0,80
02940 5040	DM 50 x diametro 40	50	1	€ 0,75



## MORSETTO IN GOMMA NERA Ø 46

CODICE	DESCRIZIONE	CF	M.V.	PREZZO
02942 4626	DM 46 x diametro 26/32	50	1	€ 0,65
02942 4640	DM 46 x diametro 40	50	1	€ 0,57

- Da utilizzare per tubo Ø 50 senza bicchiere.



## MORSETTO IN GOMMA NERA PER CURVA TECNICA

CODICE	DESCRIZIONE	CF	M.V.	PREZZO
02944 5340	DM 53 x diametro 40	50	1	€ 1,10
02944 5326	DM 53 x diametro 26/32	50	1	€ 1,33



## MORSETTO IN GOMMA BIANCA

CODICE	DESCRIZIONE	CF	M.V.	PREZZO
02950 5026	DM 50 x diametro 26	50	1	€ 2,08
02950 5030	DM 50 x diametro 30	50	1	€ 1,21
02950 5530	DM 55 x diametro 30	50	1	€ 1,21
02950 6030	DM 60 x diametro 30/32	50	1	€ 1,42
02950 6040	DM 60 x diametro 40/45	50	1	€ 1,85





## MORSETTO WC NERO

CODICE	DESCRIZIONE	CF	M.V.	PREZZO
02979 0000	100 x 90	1	1	€ 6,80



## PROLUNGA GOMMA NERA PER WC

CODICE	DESCRIZIONE	CF	M.V.	PREZZO
02980 0000	DM esterno 110 - interno 95	1	1	€ 7,48

- Adatto a braghe diametro 110 e wc mm 98/103



## MORSETTO WC NERO

CODICE	DESCRIZIONE	CF	M.V.	PREZZO
02981 000	110 x 100-90	1	1	€ 6,80

## GUARNIZIONE PER CURVA WC 125

CODICE	DESCRIZIONE	CF	M.V.	PREZZO
02982 1290	125 x 90	1	1	€ 4,50



## GUARNIZIONE PER CURVA WC 110

CODICE	DESCRIZIONE	CF	M.V.	PREZZO
02984 0000	110 x 100	1	1	€ 2,75



## MORSETTO WC NERO

CODICE	DESCRIZIONE	CF	M.V.	PREZZO
02986 0000	100/110	1	1	€ 2,10



## GUARNIZIONE PER CURVA WC 120

CODICE	DESCRIZIONE	CF	M.V.	PREZZO
02983 0000	120 x 110/90	1	1	€ 3,45





## MORSETTO WC BIANCO 110/90

CODICE	DESCRIZIONE	CF	M.V.	PREZZO
02960 0000	Concentrica	30	1	€ 2,50



## MORSETTO WC BIANCO 110/90

CODICE	DESCRIZIONE	CF	M.V.	PREZZO
02962 0000	Eccentrica	30	1	€ 2,50



## MORSETTO WC BIANCO CONCENTRICO

CODICE	DESCRIZIONE	CF	M.V.	PREZZO
02961 0000	110/90	36	1	€ 3,40



## MORSETTO WC BIANCO ECCENTRICO

CODICE	DESCRIZIONE	CF	M.V.	PREZZO
02963 0000	110/90	36	1	€ 3,40



## MORSETTO WC ECCENTRICO

CODICE	DESCRIZIONE	CF	M.V.	PREZZO
02964 0000	cm 4	1	1	€ 6,10



## MORSETTO WC ECCENTRICO

CODICE	DESCRIZIONE	CF	M.V.	PREZZO
02965 0000	cm 6	16	1	€ 6,50



## MORSETTO WC PROLUNGATO

CODICE	DESCRIZIONE	CF	M.V.	PREZZO
02966 0000	concentrica	1	1	€ 11,30



## MORSETTO WC ALLUNGABILE

CODICE	DESCRIZIONE	CF	M.V.	PREZZO
02968 0000	CM 27,5/50 F 80-100 x M 100-100	1	1	€ 8,93





## CURVA TECNICA SOTTOLAVABO

CODICE	DESCRIZIONE	CF	M.V.	PREZZO
02973 0000	90 - 100 - 110	12	1	€ 15,75



## KIT DI FISSAGGIO PER CURVE TECNICHE

CODICE	DESCRIZIONE	CF	M.V.	PREZZO
02975 0000	--	1	1	€ 5,00



## CURVA WC COMPEX ESTENSIBILE

CODICE	DESCRIZIONE	CF	M.V.	PREZZO
02969 0000	--	24	1	€ 13,16

- Estensibile 28-52 cm
- Con ispezione  $\varnothing$  40



## CURVA WC REGOLABILE PER SCARICO A PAVIMENTO

CODICE	DESCRIZIONE	CF	M.V.	PREZZO
02970 0000	completa di fissaggio	16	1	€ 17,50

- Ideale per ristrutturazioni



## CURVA WC REGOLABILE

CODICE	DESCRIZIONE	CF	M.V.	PREZZO
02972 0000	completa di fissaggio	15	1	€ 19,50

- da tagliare



## SET WC SOSPESO ECCENTRICO

CODICE	DESCRIZIONE	CF	M.V.	PREZZO
02974 0000	DM 90 + DM 45	12	1	€ 22,00

- Per wc filo muro.  
- Per wc sospeso.





## COLONNA VASCA IN POLIPROPILENE

CODICE	DESCRIZIONE	CF	M.V.	PREZZO
03000 0000	1 - ½ x 60 mm - L. max 55 cm	1	1	€ 34,75



## TAPPAGUASTI PER VASCA A SCATTO

CODICE	DESCRIZIONE	CF	M.V.	PREZZO
03002 0000	Ø 74 mm	1	1	€ 29,34



## TAPPO AD ESPANSIONE PER POZZETTO

CODICE	DESCRIZIONE	CF	M.V.	PREZZO
03004 0100	Ø 100 senza placca	1	1	€ 2,50
03006 0100	Ø 100 con placca	1	1	€ 3,25
03006 0120	Ø 120 con placca	1	1	€ 7,35



## GRIGLIA OTTONE PER DOCCIA

CODICE	DESCRIZIONE	CF	M.V.	PREZZO
03008 0000	Ø 64	1	1	€ 6,50

## CODOLO CURVO PEHD CON DADO IN OTTONE

CODICE	DESCRIZIONE	CF	M.V.	PREZZO
03010 0740	1-1/4 x 40 mm	5	1	€ 6,55
03010 0840	1-1/2 x 40 mm	5	1	€ 7,03



**ES bonomini**  
PERIODICI

## CODOLO DRITTO PEHD CON DADO IN OTTONE

CODICE	DESCRIZIONE	CF	M.V.	PREZZO
03012 0740	1-1/4 x 40 mm	5	1	€ 6,55
03012 0840	1-1/2 x 40 mm	5	1	€ 7,03



**ES bonomini**  
PERIODICI

## SIFONE RIBASSATO ORIENTABILE

CODICE	DESCRIZIONE	CF	M.V.	PREZZO
03016 0000	1-1/2 x 40/50	1	1	€ 12,00

- Con codolo in ottone



**ES bonomini**  
PERIODICI

## CURVA CONNESSIONE PER SIFONE 1-1/2

CODICE	DESCRIZIONE	CF	M.V.	PREZZO
03020 0000	45° DM 40 x DM 50	1	1	€ 1,26





## PILETTA A PAVIMENTO CON SIFONE RIBASSATO H60

CODICE	DESCRIZIONE	CF	M.V.	PREZZO
03030 0000	Flangia Inox 105 x 105	1	1	€ 32,80



## PILETTA DOCCIA FORO 60 mm

CODICE	DESCRIZIONE	CF	M.V.	PREZZO
03040 0000	1 - 1/2	1	1	€ 16,28



## PILETTA PER DOCCIA FORO 90 mm

CODICE	DESCRIZIONE	CF	M.V.	PREZZO
03042 0000	Coperchio ABS diametro 120	1	1	€ 10,45

- Scarico filettato 1 - 1/2, ideale per tutti i piatti doccia in acrilico



## PILETTA PER DOCCIA FORO 90 MM

CODICE	DESCRIZIONE	CF	M.V.	PREZZO
03044 0000	Coperchio ABS DM 120 Scarico filettato 1 - 1/2	1	1	€ 22,84



## PILETTA PER DOCCIA SLIM FORO 90 mm

CODICE	DESCRIZIONE	CF	M.V.	PREZZO
03046 0000	DM 90 x 40 - H 51 mm	1	1	€ 27,30

- Con valvola gravitazionale.



## PILETTA DOCCIA SLIM H56

CODICE	DESCRIZIONE	CF	M.V.	PREZZO
03047 0000	DM 90 x 40 - H56 mm	1	1	€ 14,50



## SIFONE DOCCIA ULTRARIBASSATO

CODICE	DESCRIZIONE	CF	M.V.	PREZZO
03048 0000	DM 120 mm x 50	1	1	€ 46,20



# D13 - CHIUSINI DOCCIA

**New**



## CHIUSINO SIFONATO IN PP GRIGIO CON SCARICO VERTICALE

CODICE	DESCRIZIONE	CF	M.V.	PREZZO
07185 1010	10x10 - H 45 - uscita 32/40	1	1	€ 2,00
07185 2020	20x20 - H 75 - uscita 75/80/100/110	1	1	€ 8,00
07185 3030	30x30 - H 105 - uscita 110/125/160	1	1	€ 16,00



**New**



## CHIUSINO SIFONATO ORIENTABILE C/SCARICO LATERALE IN PP GRIGIO

CODICE	DESCRIZIONE	CF	M.V.	PREZZO
07186 1010	10x10 - H 82 - uscita 50	1	1	€ 8,00
07186 2020	20x20 - H 72 - uscita 50	1	1	€ 16,00



**New**



## CHIUSINO SIFONATO C/SCARICO LATERALE IN PP GRIGIO E GRIGLIA INOX

CODICE	DESCRIZIONE	CF	M.V.	PREZZO
07187 1010	10x10 - H 82 - uscita 50	1	1	€ 16,00



## POZZETTO IN PP GRIGIO

CODICE	DESCRIZIONE	CF	M.V.	PREZZO
07180 2020	20 x 20 - gr 592	1	1	€ 3,95
07180 3030	30 x 30 - gr 1430	1	1	€ 9,90
07180 4040	40 x 40 - gr 3550	1	1	€ 25,00
07180 5555	55 x 55 - gr 6000	1	1	€ 65,80



**New**

## COPERCHIO PER POZZETTO IN PP GRIGIO

CODICE	DESCRIZIONE	CF	M.V.	PREZZO
07182 2020	20 x 20 - gr 270	1	1	€ 2,63
07182 3030	30 x 30 - gr 570	1	1	€ 5,92
07182 4040	40 x 40 - gr 1920	1	1	€ 14,50
07182 5555	55 x 55 - gr 3725	1	1	€ 39,50



**New**

## GRIGLIA PER POZZETTO IN PP GRIGIO

CODICE	DESCRIZIONE	CF	M.V.	PREZZO
07183 2020	20 x 20 - gr 270	1	1	€ 2,63
07183 3030	30 x 30 - gr 570	1	1	€ 5,92



**New**

## TELAIO E COPERCHIO IN PP GRIGIO

CODICE	DESCRIZIONE	CF	M.V.	PREZZO
07181 2020	20 x 20	5	1	€ 5,50
07181 3030	30 x 30	5	1	€ 11,00
07181 4040	40 x 40	5	1	€ 22,00
07181 5555	55 x 55	4	1	€ 59,00



**New**



## TUBO CARICO LAVATRICE C/CURVA

CODICE	DESCRIZIONE	CF	M.V.	PREZZO
03100 0150	cm 150	10	1	€ 4,45
03100 0200	cm 200	10	1	€ 4,97
03100 0300	cm 300	10	1	€ 6,92



## TUBO SCARICO LAVATRICE ESTENSIBILE

CODICE	DESCRIZIONE	CF	M.V.	PREZZO
03102 0000	90 - 300	1	1	€ 3,70

- Adatto anche per lavastoviglie.



## TUBO SCARICO LAVATRICE ESTENSIBILE

CODICE	DESCRIZIONE	CF	M.V.	PREZZO
03104 0000	100 - 220 Bonomini	1	1	€ 6,80



## NIPPLES GIUNZIONE CARICO LAVATRICE

CODICE	DESCRIZIONE	CF	M.V.	PREZZO
03101 0000	3/4	100	1	€ 0,49

## SIFONE LAVATRICE INCASSO DOPPIO BIBOX

CODICE	DESCRIZIONE	CF	M.V.	PREZZO
03111 0000	1" x 40/50	24	1	€ 47,25



## SIFONE INCASSO LAVATRICE

CODICE	DESCRIZIONE	CF	M.V.	PREZZO
03110 0000	40 - 50	1	1	€ 5,37



## SIFONE ESTERNO LAVATRICE

CODICE	DESCRIZIONE	CF	M.V.	PREZZO
03112 0000	Bianco	10	1	€ 3,53



## ATTACCO PORTAGOMMA CURVO PER LAVATRICE

CODICE	DESCRIZIONE	CF	M.V.	PREZZO
02714 0000	1" - Bianco	20	1	2,42





**P**ILETTE

**S**IFONI

**R**OSETTE

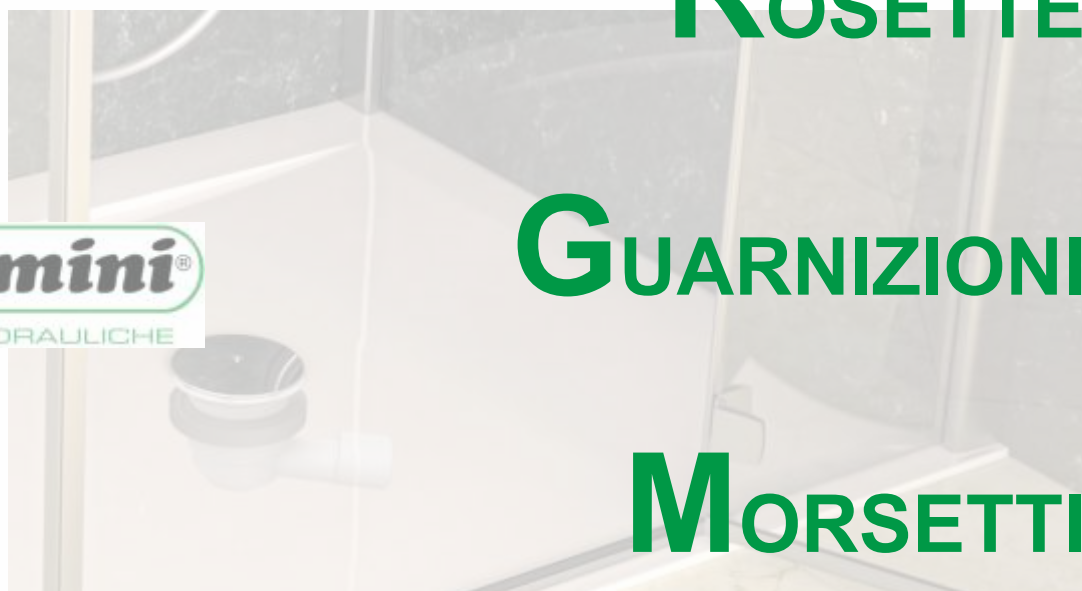

**G**UARNIZIONI

**M**ORSETTI

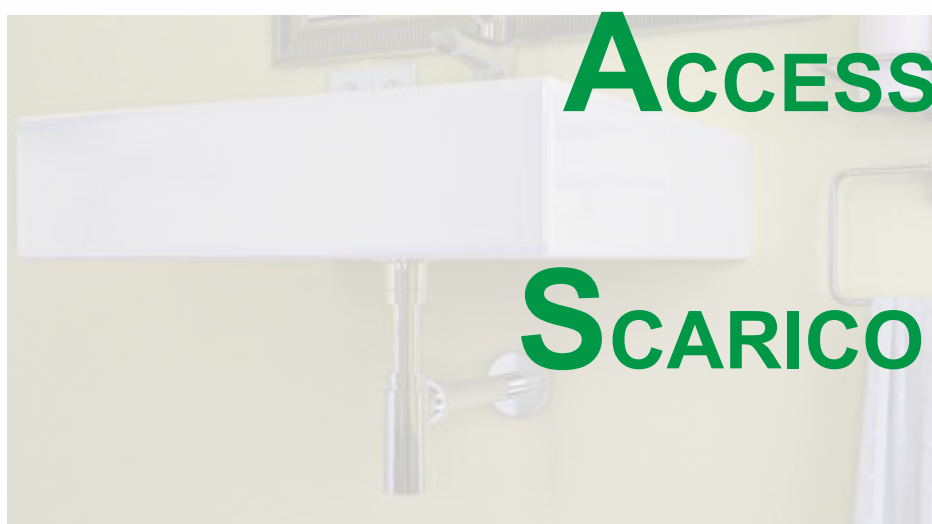

**A**CCESSORI **V**ASCA

**S**CARICO **L**AVATRICE

**CGS**

VALVOLE A SFERA

REGOLATORI GAS

E GALLEGGIANTI

*La felicità non dipende da quello che ci manca,  
ma dal buon uso che facciamo  
di quello che abbiamo.*

*Arnaud Desjardins*



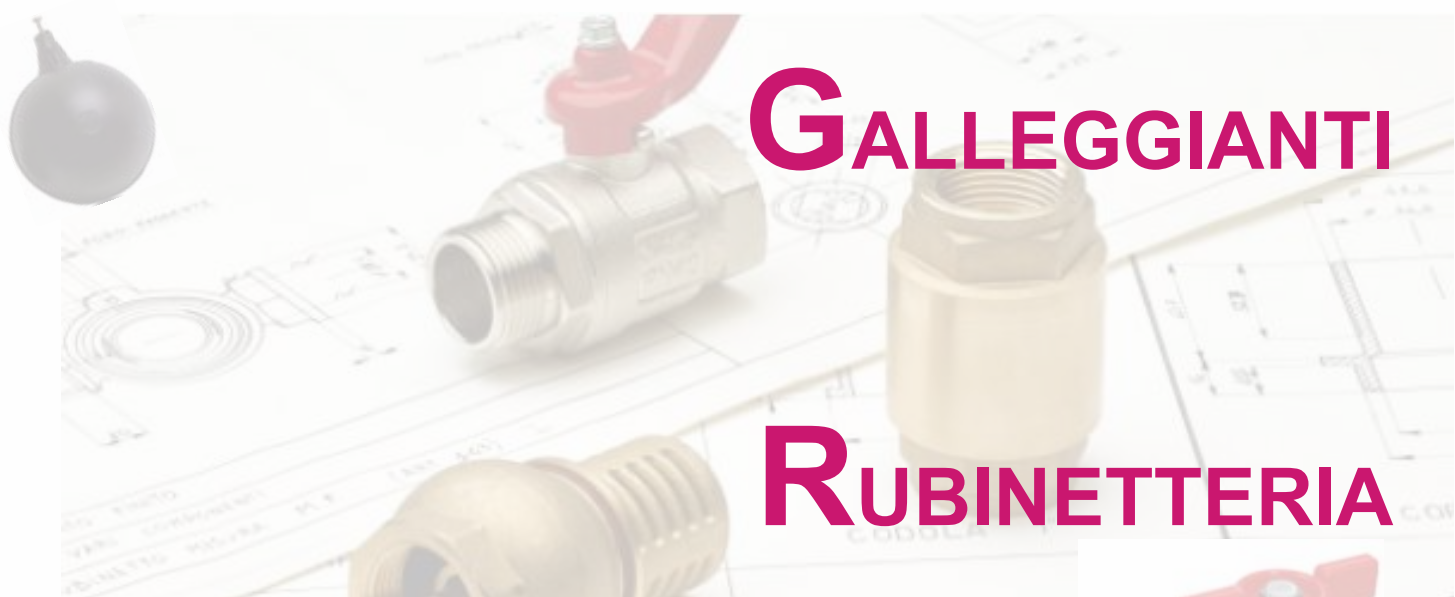

**GALLEGGIANTI**

**RUBINETTERIA**



Rubinetteria Metella Giovanni  
*evolution*



**VALVOLE A SFERA**



**FLESSIBILI ACCIAIO**



**REGOLATORI GAS**



**CONTATORI ACQUA**

## RUBINETTO A SFERA CON PORTAGOMMA

CODICE	DESCRIZIONE	CF	M.V.	PREZZO
04010 0400	1/2 x 3/4	20	1	€ 7,45
04010 0500	3/4 x 1"	12	1	€ 9,65
04010 0600	1" x 1-1/4	8	1	€ 19,87



## RUBINETTO A SFERA CON LEVA BLU

CODICE	DESCRIZIONE	CF	M.V.	PREZZO
04011 0400	1/2 x 3/4	15	1	€ 11,44



## RUBINETTO A SFERA + MINIVALVOLA

CODICE	DESCRIZIONE	CF	M.V.	PREZZO
04012 0400	1/2 x 3/4 x 3/4	10	1	€ 19,20



## RUBINETTO A SFERA CON PORTALUCCHETTO

CODICE	DESCRIZIONE	CF	M.V.	PREZZO
04009 0400	1/2	20	1	€ 10,00



# E1 - RUBINETTI GIARDINO



## RUBINETTO A SFERA CON PORTAGOMMA LEVA NERA

CODICE	DESCRIZIONE	CF	M.V.	PREZZO
04019 0400	1/2 x 3/4	10	1	€ 8,97



## RUBINETTO PORTAGOMMA EKO

CODICE	DESCRIZIONE	CF	M.V.	PREZZO
04013 0400	1/2	1	1	€ 14,22



## RUBINETTO PORTAGOMMA EKO LUX

CODICE	DESCRIZIONE	CF	M.V.	PREZZO
04015 0400	1/2 cromato	1	1	€ 22,95



## RUBINETTO CROMATO C/FARFALLA C/PORTAGOMMA

CODICE	DESCRIZIONE	CF	M.V.	PREZZO
04022 0400	1/2" con portagomma	10	1	€ 16,31

## RUBINETTO CROMATO C/POMELLO E PORTAGOMMA

CODICE	DESCRIZIONE	CF	M.V.	PREZZO
04021 0400	1/2	6	1	€ 28,35



## RUBINETTO CROMATO C/POMELLO

CODICE	DESCRIZIONE	CF	M.V.	PREZZO
04020 0400	1/2"	1	1	€ 25,35



## RUBINETTO INCLINATO A LEVA IN OTTONE CROMATO

CODICE	DESCRIZIONE	CF	M.V.	PREZZO
04023 0000	1/2	12	1	€ 18,80

- Passo rapido



## RUBINETTO A PULSANTE PER FONTANE

CODICE	DESCRIZIONE	CF	M.V.	PREZZO
04027 0000	1/2	5	1	€ 49,40

- Ottone giallo lucido



# E1 - RUBINETTI GIARDINO



## RUBINETTO OLIO

CODICE	DESCRIZIONE	CF	M.V.	PREZZO
04018 0400	1/2	30	1	€ 8,70



## RUBINETTO OTTONE GIALLO

CODICE	DESCRIZIONE	CF	M.V.	PREZZO
04024 0400	1/2"	8	1	€ 10,45



## RUBINETTO OTTONE GIALLO

CODICE	DESCRIZIONE	CF	M.V.	PREZZO
04026 0400	1/2" con portagomma	8	1	€ 20,80



## RUBINETTO OTTONE ARTISTICO

CODICE	DESCRIZIONE	CF	M.V.	PREZZO
04028 0400	1/2" con leva	1	1	€ 37,50

## ROSONE OTTONE GIALLO PER RUBINETTO ARTISTICO

CODICE	DESCRIZIONE	CF	M.V.	PREZZO
04029 0400	1/2	1	1	€ 6,70

**New**



## RACCORDO PORTAGOMMA MASCHIO TIPO ROMA

CODICE	DESCRIZIONE	CF	M.V.	PREZZO
06700 2004	20 x 1/2	10	1	€ 2,45
06700 2505	25 x 3/4	25	1	€ 4,70
06700 3006	30 x 1"	25	1	€ 5,70
06700 4007	40 x 1-1/4	15	1	€ 9,50

**New**



- Ottone giallo.

## PORTAGOMMA IN OTTONE CROMATO

CODICE	DESCRIZIONE	CF	M.V.	PREZZO
04014 0400	3/4 x rubinetto 1/2	20	1	€ 1,60
04014 0500	1" x rubinetto 3/4	10	1	€ 3,05
04014 0600	1 - 1/4 x rubinetto 1"	10	1	€ 5,16



## FASCETTA STRINGITUBO

CODICE	DESCRIZIONE	CF	M.V.	PREZZO
04016 0812	10 - 16	100	10	€ 0,79
04016 1222	12 - 22	100	10	€ 0,79
04016 1627	16 - 25	100	10	€ 0,79
04016 2032	20 - 32	100	10	€ 0,83
04016 2540	25 - 40	100	10	€ 0,83
04016 3250	32 - 50	100	10	€ 0,89
04016 4060	40 - 60	100	10	€ 0,95
04016 5070	50 - 70	100	10	€ 0,95



## E2 - VALVOLE A SFERA MINI



### VALVOLA A SFERA MINI FF

CODICE	DESCRIZIONE	CF	M.V.	PREZZO
04102 0300	3/8	30	1	€ 5,50
04102 0400	1/2	25	1	€ 6,39



### VALVOLA A SFERA MINI MF

CODICE	DESCRIZIONE	CF	M.V.	PREZZO
04104 0300	3/8	30	1	€ 5,07
04104 0400	1/2	25	1	€ 5,07



### VALVOLA A SFERA MINI MF CROMATA

CODICE	DESCRIZIONE	CF	M.V.	PREZZO
04106 0400	1/2 cromata	25	1	€ 6,31



## LA SCELTA DI CHI NON SCENDE A COMPROMESSI

Dal 1973, abbiamo conquistato la fiducia dei professionisti più esigenti in oltre **80 Paesi** al mondo con ben **16 certificazioni internazionali**.

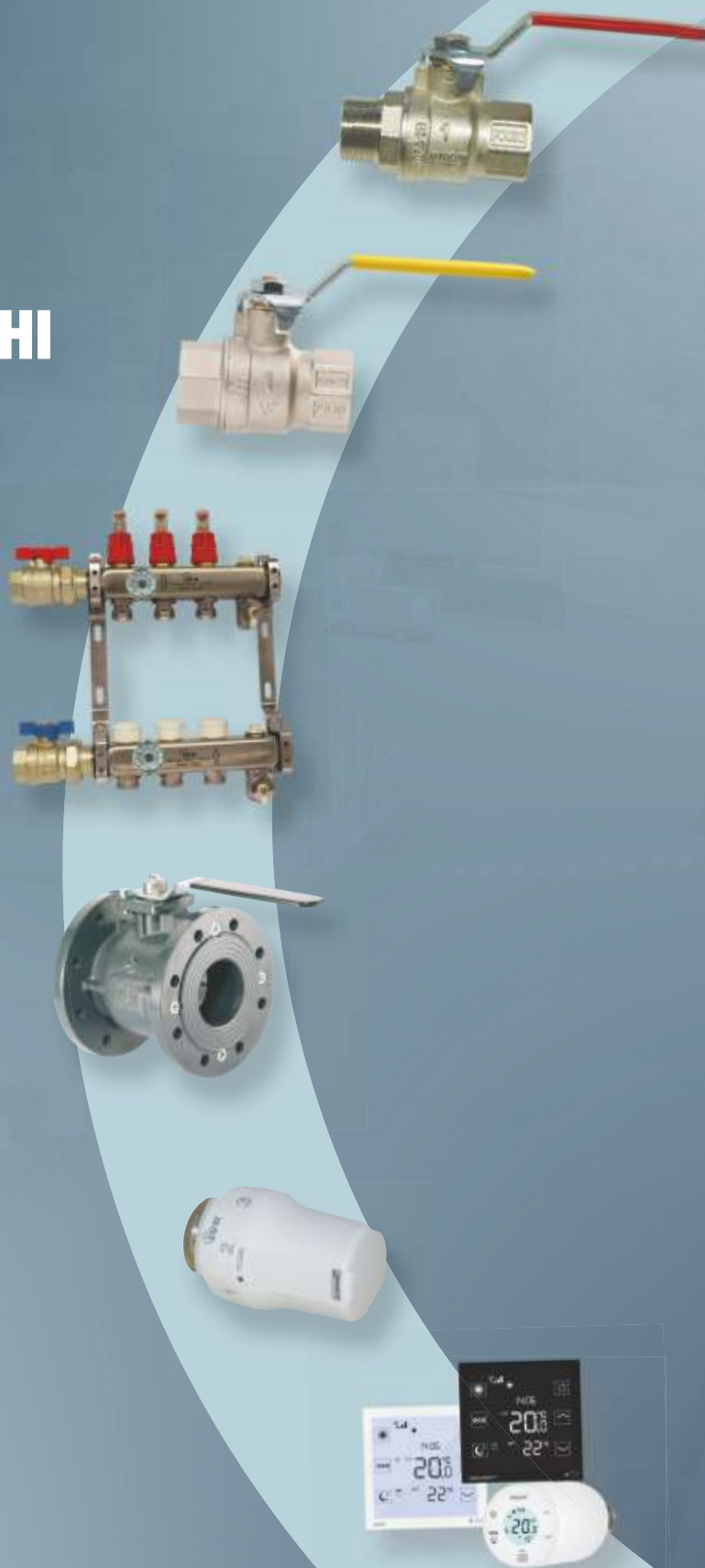

SCOPRI LA  
#QUALITÀIVR



## E3 - VALVOLE A SFERA



### VALVOLA A SFERA C/LEVA PASSAGGIO TOTALE PN40

CODICE	DESCRIZIONE	CF	M.V.	PREZZO
04120 0200	FF 1/4	30	1	€ 6,96
04120 0300	FF 3/8	30	1	€ 6,96
04120 0400	FF 1/2	24	1	€ 7,23
04120 0500	FF 3/4	20	1	€ 9,85
04120 0600	FF 1"	15	1	€ 15,53
04120 0700	FF 1 - 1/4	6	1	€ 29,10
04120 0800	FF 1 - 1/2	6	1	€ 44,20
04120 0900	FF 2"	1	1	€ 68,55
04120 1000	FF 2 - 1/2	1	1	€ 112,96
04120 1100	FF 3"	1	1	€ 178,56
04120 1200	FF 4"	1	1	€ 268,56



### VALVOLA A SFERA C/LEVA PASSAGGIO TOTALE PN40

CODICE	DESCRIZIONE	CF	M.V.	PREZZO
04122 0400	MF 1/2	24	1	€ 7,43
04122 0500	MF 3/4	20	1	€ 11,09
04122 0600	MF 1"	15	1	€ 16,70
04122 0700	MF 1 - 1/4	6	1	€ 29,02
04122 0800	MF 1 - 1/2	6	1	€ 44,83
04122 0900	MF 2"	1	1	€ 69,90



### VALVOLA A SFERA C/FARFALLA PASSAGGIO TOTALE PN40

CODICE	DESCRIZIONE	CF	M.V.	PREZZO
04130 0400	FF 1/2	30	1	€ 7,23
04130 0500	FF 3/4	20	1	€ 9,85
04130 0600	FF 1"	20	1	€ 15,69



### VALVOLA A SFERA C/FARFALLA PASSAGGIO TOTALE PN40

CODICE	DESCRIZIONE	CF	M.V.	PREZZO
04132 0400	MF 1/2	30	1	€ 7,23
04132 0500	MF 3/4	20	1	€ 10,58
04132 0600	MF 1"	20	1	€ 16,30



## VALVOLA A SFERA C/LEVA IN ACCIAIO AISI 304

CODICE	DESCRIZIONE	CF	M.V.	PREZZO
04136 0400	FF 1/2 H 70 L 56	10	1	€ 9,50
04136 0500	FF 3/4 H 75 L 65	10	1	€ 13,20
04136 0600	FF 1" H 85 L 75	10	1	€ 17,90

- Sede in PTFE
- PN30

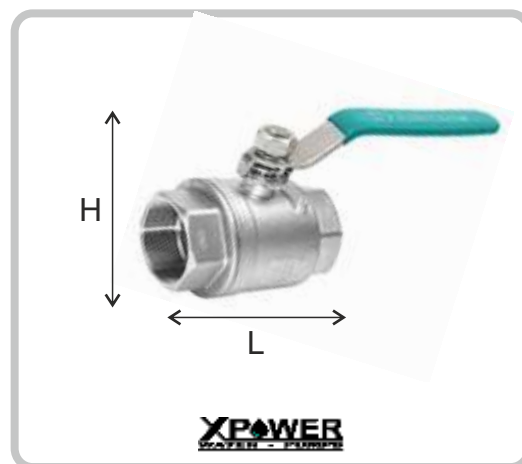

## VALVOLA A SFERA C/LEVA IN ACCIAIO AISI 304

CODICE	DESCRIZIONE	CF	M.V.	PREZZO
04138 0400	MF 1/2 H 70 L 70	10	1	€ 10,30
04138 0500	MF 3/4 H 75 L 75	10	1	€ 14,20
04138 0600	MF 1" H 85 L 90	10	1	€ 18,40

- Sede in PTFE
- PN30



## VALVOLA A SFERA MINI MF ACCIAIO AISI 316

CODICE	DESCRIZIONE	CF	M.V.	PREZZO
04108 0400	1/2	10	1	€ 21,70

- Tenuta P.T.F.E.
- Ottenuta da barra in acciaio inox.



## VALVOLA RITEGNO IN ACCIAIO INOX 316

CODICE	DESCRIZIONE	CF	M.V.	PREZZO
05043 0400	1/2	1	1	€ 23,70
05043 0500	3/4	1	1	€ 29,00
05043 0600	1"	1	1	€ 37,00
05043 0700	1 - 1/4	1	1	€ 45,00

- Tenuta P.T.F.E.



## E5 - VALVOLE A SFERA CON RACCORDO



**APM**

### VALVOLA A SFERA C/FARFALLA PASSAGGIO TOTALE PN16

CODICE	DESCRIZIONE	CF	M.V.	PREZZO
04110 0400	Con raccordo MF ½	20	1	€ 11,17
04110 0500	Con raccordo MF 3/4	15	1	€ 15,87
04110 0600	Con raccordo MF 1"	12	1	€ 27,60
04110 0700	Con raccordo MF 1 - 1/4	6	1	€ 45,15



**IVR**

### VALVOLA A SFERA C/FARFALLA PASSAGGIO TOTALE IVR

CODICE	DESCRIZIONE	CF	M.V.	PREZZO
04112 0400	MF ½ c/raccordo	10	1	€ 12,60
04112 0500	MF 3/4 c/raccordo	10	1	€ 17,85
04112 0600	MF 1" c/raccordo	10	1	€ 28,90
04112 0700	MF 1-1/4 c/raccordo	6	1	€ 48,80



**APM**

### VALVOLA A SFERA C/FARFALLA A SQUADRA PASSAGGIO TOTALE

CODICE	DESCRIZIONE	CF	M.V.	PREZZO
04114 0400	Con raccordo MF ½	20	1	€ 15,16
04114 0500	Con raccordo MF 3/4	20	1	€ 20,80
04114 0600	Con raccordo MF 1"	9	1	€ 35,83



**ENOLGAS**

### VALVOLA A SFERA A SQUADRA PER CALDAIA E COLLETTORI

CODICE	DESCRIZIONE	CF	M.V.	PREZZO
04116 0400	½ c/codolo	1	1	€ 13,05
04116 0500	3/4 c/codolo	1	1	€ 15,75



# E5 - VALVOLE A SFERA CON RACCORDO

## VALVOLA A SFERA A SQUADRA CON RACCORDO DM 20

CODICE	DESCRIZIONE	CF	M.V.	PREZZO
04117 0520	3/4 c/codolo x DM 20	1	1	€ 20,40



## VALVOLA A SFERA C/FARFALLA FRONTALE C/CODOLO

CODICE	DESCRIZIONE	CF	M.V.	PREZZO
04118 0605	1" x 3/4	1	1	€ 31,50
04118 0606	1" x 1"	1	1	€ 41,30

- Reversibile
- Leva blu



## VALVOLA A SFERA C/FARFALLA FRONTALE C/CODOLO

CODICE	DESCRIZIONE	CF	M.V.	PREZZO
04119 0605	1" x 3/4	1	1	€ 31,50
04119 0606	1" x 1"	1	1	€ 41,30

- Reversibile
- Leva rossa



## TENUTTA MULTISTRATO PER VALVOLA LEVA FRONTALE

CODICE	DESCRIZIONE	CF	M.V.	PREZZO
04115 0020	DM 20/1"	1	1	€ 10,88
04115 0026	DM 26/1"	1	1	€ 10,88



## E6 - VALVOLE INCASSO



### VALVOLA A SFERA DA INCASSO PASSAGGIO TOTALE

CODICE	DESCRIZIONE	CF	M.V.	PREZZO
04140 0400	½ c/capuccio	10	1	€ 32,50
04141 0400	½ c/leva	10	1	€ 39,95

- Con sistema asta e sfera estraibili.



### VALVOLA A VITONE DA INCASSO

CODICE	DESCRIZIONE	CF	M.V.	PREZZO
04142 0400	½	2	1	€ 36,50



### VALVOLA A SFERA DA INCASSO

CODICE	DESCRIZIONE	CF	M.V.	PREZZO
04144 0400	½ con leva	8	1	€ 25,50



### SARACINESCA OTTONE FF PN10

CODICE	DESCRIZIONE	CF	M.V.	PREZZO
04210 0600	1"	15	1	€ 19,50

## VALVOLA ZONA MOTORIZZATA 2 VIE 230V

CODICE	DESCRIZIONE	CF	M.V.	PREZZO
04410 0400	½ FF	1	1	€ 156,20
04410 0500	¾ FF	1	1	€ 161,92
04410 0600	1" FF	1	1	€ 179,90

- Con relè a 2 punti e un micro supplementare.



## VALVOLA ZONA MOTORIZZATA 2 VIE BOCCHETTONATE 230V

CODICE	DESCRIZIONE	CF	M.V.	PREZZO
04414 0500	¾ MM	1	1	€ 185,00
04414 0600	1" MM	1	1	€ 188,83

- Con relè a 2 punti e un micro supplementare.



## VALVOLA ZONA MOTORIZZATA 3 VIE BOCCHETTONATE 230V

CODICE	DESCRIZIONE	CF	M.V.	PREZZO
04416 0500	¾ MMM	1	1	€ 189,00
04416 0600	1" MMM	1	1	€ 204,75





## ELETTROVALVOLA IN OTTONE PESANTE NORMALMENTE CHIUSA

CODICE	DESCRIZIONE	CF	M.V.	PREZZO
04302 0400	1/2 230V	1	1	€ 86,70
04302 0600	1"	1	1	€ 159,90

- Completa di bobina.
- Per acqua e vapore fino a 130°.



## ELETTROVALVOLA IN OTTONE PESANTE NORMALMENTE APERTA

CODICE	DESCRIZIONE	CF	M.V.	PREZZO
04304 0400	1/2 230V	1	1	€ 111,56
04304 0600	1" 230V	1	1	€ 159,90

- Completa di bobina.
- Per acqua e vapore fino a 130°.



**New**

## BOBINA PER ELETTROVALVOLE 1/2 - 3/4 - 1" CORRENTE ALTERNATA

CODICE	DESCRIZIONE	CF	M.V.	PREZZO
04306 000	230V	1	1	€ 34,00

**XPOWER**  
POWER - FLUIDS



**New**

## BOBINA PER ELETTROVALVOLE 1/2 - 3/4 - 1" CORRENTE CONTINUA

CODICE	DESCRIZIONE	CF	M.V.	PREZZO
04308 0012	12V	1	1	€ 36,00
04308 0024	24V	1	1	€ 36,00

**XPOWER**  
POWER - FLUIDS

## VALVOLA A SFERA PER GAS C/LEVA FF

CODICE	DESCRIZIONE	CF	M.V.	PREZZO
04520 0400	Mis. 1/2"	12	1	€ 9,04
04520 0500	Mis. 3/4"	20	1	€ 13,62
04520 0600	Mis. 1"	12	1	€ 21,26
04520 0700	Mis. 1 1/4"	10	1	€ 27,46
04520 0800	Mis. 1 1/2"	4	1	€ 45,31
04520 0900	Mis. 2"	4	1	€ 70,76

Valvola con sfera, in ottone cromato, con attacchi femmina-femmina.  
Maniglia a leva gialla per uso gas. Passaggio integrale.  
Campo di temperatura -20:185°C



## VALVOLA A SFERA PER GAS C/LEVA MF

CODICE	DESCRIZIONE	CF	M.V.	PREZZO
04522 0400	Mis. 1/2"	10	1	€ 9,04
04522 0500	Mis. 3/4"	5	1	€ 13,75
04522 0600	Mis. 1"	5	1	€ 21,77
04522 0700	Mis. 1 - 1/4"	5	1	€ 30,21
04522 0800	Mis. 1 - 1/2"	2	1	€ 46,67



## VALVOLA A SFERA PER GAS C/FARFALLA FF

CODICE	DESCRIZIONE	CF	M.V.	PREZZO
04530 0400	Mis. 1/2"	12	1	€ 9,04
04530 0500	Mis. 3/4"	20	1	€ 12,81
04530 0600	Mis. 1"	5	1	€ 19,55

Valvola con sfera, in ottone cromato, con attacchi femmina-femmina.  
Maniglia a leva gialla per uso gas. Passaggio integrale.  
Campo di temperatura -20:185°C



## VALVOLA A SFERA PER GAS C/FARFALLA MF

CODICE	DESCRIZIONE	CF	M.V.	PREZZO
04532 0400	Mis. 1/2"	12	1	€ 9,04
04532 0500	Mis. 3/4"	5	1	€ 13,75
04532 0600	Mis. 1"	5	1	€ 22,30



## E9 - VALVOLE A SFERA GAS



### VALVOLA A SFERA GAS C/FARFALLA E PRESA PRESSIONE

CODICE	DESCRIZIONE	CF	M.V.	PREZZO
04540 0500	3/4	20	1	€ 31,75
04540 0600	1"	12	1	€ 42,60



### VALVOLA SFERA GAS C/PRESA PRESSIONE E CHIAVE

CODICE	DESCRIZIONE	CF	M.V.	PREZZO
04544 0500	3/4 FF	1	1	€ 37,98
04544 0600	1" FF	1	1	€ 65,80



### VALVOLA A SFERA A SQUADRA GAS C/PRESA PRESSIONE E CHIAVE

CODICE	DESCRIZIONE	CF	M.V.	PREZZO
04546 0500	3/4	1	1	€ 36,25
04546 0600	1"	1	1	€ 65,80



### RUBINETTO GAS DRITTO C/PORTAGOMMA M

CODICE	DESCRIZIONE	CF	M.V.	PREZZO
04550 1004	GPL DM 10 x 1/2	30	1	€ 7,90
04550 1404	Metano DM 14 x 1/2 M	30	1	€ 10,00



### RUBINETTO GAS DRITTO C/PORTAGOMMA F

CODICE	DESCRIZIONE	CF	M.V.	PREZZO
04552 1404	Metano DM 14 x 1/2 F	1	1	€ 10,00

## RUBINETTO GAS A SQUADRA CON PORTAGOMMA M

CODICE	DESCRIZIONE	CF	M.V.	PREZZO
04554 1004	½ x 10 GPL	30	1	€ 8,75
04554 1404	½ x 14 MET	30	1	€ 11,50



## RUBINETTO GAS A SQUADRA MM

CODICE	DESCRIZIONE	CF	M.V.	PREZZO
04556 0404	½ x ½	30	1	€ 8,90



## RUBINETTO GAS A SQUADRA MF CON GIRELLO

CODICE	DESCRIZIONE	CF	M.V.	PREZZO
04558 0404	½ x ½	30	1	€ 11,65
04558 0405	½ x ¾	30	1	€ 14,45



## RUBINETTO GAS A SQUADRA MF

CODICE	DESCRIZIONE	CF	M.V.	PREZZO
04559 0404	½ x ½ senza girello	30	1	€ 7,80



# E10 - TUBO GOMMA GAS E ACCESSORI



## TUBO GOMMA GAS

CODICE	DESCRIZIONE	CF	M.V.	PREZZO
04660 0000	GPL 8x13	100	100	€ 1,31
04661 0000	Metano 13x19,5	50	50	€ 3,00



## GUARNIZIONE PER BOMBOLA

CODICE	DESCRIZIONE	CF	M.V.	PREZZO
02909 0400	1/2 "	100	100	€ 0,13



## FASCETTA STRINGITUBO

CODICE	DESCRIZIONE	CF	M.V.	PREZZO
04016 0812	10 - 16	100	10	€ 0,79
04016 1222	12 - 22	100	10	€ 0,79
04016 1627	16 - 25	100	10	€ 0,79
04016 2032	20 - 32	100	10	€ 0,83
04016 2540	25 - 40	100	10	€ 0,83
04016 3250	32 - 50	100	10	€ 0,89
04016 4060	40 - 60	100	10	€ 0,95
04016 5070	50 - 70	100	10	€ 0,95



**New**

## CHIAVE PER BOMBOLA

CODICE	DESCRIZIONE	CF	M.V.	PREZZO
04629 0000	--	1	1	€ 2,40

## MANICOTTO PORTAGOMMA GPL

CODICE	DESCRIZIONE	CF	M.V.	PREZZO
04670 0000	GPL	1	1	€ 2,90



## TES PORTAGOMMA GPL

CODICE	DESCRIZIONE	CF	M.V.	PREZZO
04672 0000	GPL	1	1	€ 3,99



## Y PORTAGOMMA GPL

CODICE	DESCRIZIONE	CF	M.V.	PREZZO
04674 0000	GPL	1	1	€ 3,67



## RACCORDO ENTRATA GAS C/GIRELLO

CODICE	DESCRIZIONE	CF	M.V.	PREZZO
04680 0402	1/2 F x 1/4 M	1	1	€ 4,00





## RACCORDO PORTAGOMMA DRITTO F

CODICE	DESCRIZIONE	CF	M.V.	PREZZO
04662 1004	½ GPL Femmina	1	1	€ 2,45
04662 1404	½ MTN Femmina	1	1	€ 2,55



## RACCORDO PORTAGOMMA DRITTO M

CODICE	DESCRIZIONE	CF	M.V.	PREZZO
04664 1004	½ GPL Maschio	1	1	€ 2,45
04664 1404	½ MTN Maschio	1	1	€ 2,55



## RACCORDO PORTAGOMMA DRITTO F C/GIRELLO

CODICE	DESCRIZIONE	CF	M.V.	PREZZO
04665 1004	1/2 F x 10 GPL porto gomma	1	1	€ 4,47



## GOMMO PORTAGOMMA F

CODICE	DESCRIZIONE	CF	M.V.	PREZZO
04666 1004	½ GPL femmina	1	1	€ 2,98
04666 1404	½ Metano femmina	1	1	€ 2,98



## GOMMO PORTAGOMMA M

CODICE	DESCRIZIONE	CF	M.V.	PREZZO
04668 1004	½ GPL maschio	1	1	€ 3,71
04668 1404	½ Metano maschio	1	1	€ 3,71

## ADATTATORE PER PORTAGOMMA GPL/MTN

CODICE	DESCRIZIONE	CF	M.V.	PREZZO
04676 0000	½ SX	1	1	€ 8,00



## NIPPLES OTTONE GIALLO DX/SX

CODICE	DESCRIZIONE	CF	M.V.	PREZZO
04678 0000	½	10	1	€ 3,40



## KIT UGELLI PER CUCINA

CODICE	DESCRIZIONE	CF	M.V.	PREZZO
04679 1000	GPL	1	1	€ 3,50
04679 1400	Metano	1	1	€ 3,50



## FILTRO GAS

CODICE	DESCRIZIONE	CF	M.V.	PREZZO
04625 0400	1/2	1	1	€ 24,50





**Gnali Bocia**  
Mondial GB

Prodotti per GAS GPL

Regolatori di Bassa Pressione  
Riduttori di Alta Pressione  
Minicentraline e Centraline  
Raccordi e Accessori

MADE IN ITALY

Prodotti per ACQUA e FLUIDI

Riduttori di pressione  
Valvole di sicurezza  
Stabilizzatori di pressione  
Valvole intercettazione combustibile

## REGOLATORE BASSA PRESSIONE PER USO DOMESTICO

CODICE	DESCRIZIONE	CF	M.V.	PREZZO
04682 0000	Taratura 20/60 MBAR	1	1	€ 7,40

1,1 Kg/h



MONDIAL

## REGOLATORE BASSA PRESSIONE PER USO DOMESTICO

CODICE	DESCRIZIONE	CF	M.V.	PREZZO
04683 0000	Taratura fissa 30 MBAR	1	1	€ 7,40

1,1 Kg/h



MONDIAL

## REGOLATORE ALTA PRESSIONE

CODICE	DESCRIZIONE	CF	M.V.	PREZZO
04685 0000	0 - 4 bar	1	1	€ 13,00



MONDIAL

## REGOLATORE 1° STADIO C/MANOMETRO

CODICE	DESCRIZIONE	CF	M.V.	PREZZO
04684 2500	25 Kg/h - c/manometro	1	1	€ 78,75
04684 1200	12 Kg/h - c/manometro	1	1	€ 46,70



MONDIAL



## REGOLATORE 2° STADIO C/CODOLO

CODICE	DESCRIZIONE	CF	M.V.	PREZZO
04686 0400	4 Kg/h - c/codolo	1	1	€ 20,00
04686 0700	7 Kg/h - c/codolo	1	1	€ 28,50
04686 1000	10 Kg/h - c/codolo	1	1	€ 34,19



## REGOLATORE 2° STADIO

CODICE	DESCRIZIONE	CF	M.V.	PREZZO
04687 0400	4 Kg/h - 1/4 x 3/8	1	1	€ 14,10
04687 0700	7 Kg - 1/4 x 1/2	1	1	€ 26,10
04687 1000	10 Kg/h - 1/2 x 1/2	1	1	€ 28,50



## MINI CENTRALINA A 2 ATTACCHI

CODICE	DESCRIZIONE	CF	M.V.	PREZZO
04688 0300	Singolo stadio - 4 kg	1	1	€ 48,00
04688 0700	Singolo stadio - 7 kg	1	1	€ 58,00



## MINICENTRALINE A 2 ATTACCHI

CODICE	DESCRIZIONE	CF	M.V.	PREZZO
04689 0000	doppio stadio	1	1	€ 94,00

I° Stadio - 12 kg - 1,5 bar

II° Stadio - 4 kg - 30 Mbar



## CENTRALINA 2 ATTACCHI PER BOMBOLE GPL KOMPACT

CODICE	DESCRIZIONE	CF	M.V.	PREZZO
04621 0000	senza flessibili	1	1	€ 85,80

- Con valvola di sicurezza e manometro



## CENTRALINA 2 ATTACCHI PER BOMBOLE GPL

CODICE	DESCRIZIONE	CF	M.V.	PREZZO
04620 0000	senza flessibili	1	1	€ 85,80

- Con valvola di sicurezza e manometro



## RILEVATORE GAS DOMESTICO «CO»

CODICE	DESCRIZIONE	CF	M.V.	PREZZO
04632 0000	--	1	1	€ 195,00

- Installare ad almeno 1,85 mt da fonti che possono rilasciare CO.  
- In ogni stanza da letto ad almeno 1,5 mt di altezza.



## RILEVATORE FUGHE GAS - INCLUSO ELETTROVALVOLA

CODICE	DESCRIZIONE	CF	M.V.	PREZZO
04630 1000	GPL - 3/4	1	1	€ 151,90
04630 1400	Metano - 3/4	1	1	€ 151,90



**New**



## GAS SEAL

CODICE	DESCRIZIONE	CF	M.V.	PREZZO
07253 0000	100 gr	1	24	€ 16,25

- Prodotto anaerobico con elevata resistenza meccanica; per gas; GPL; metano; idrocarburi; olii; nafta.



## FLESS GAS 1/2x1/2

CODICE	DESCRIZIONE	CF	M.V.	PREZZO
04690 0050	cm 50	1	1	€ 8,00
04690 0070	cm 70	1	1	€ 8,80
04690 0100	cm 100	1	1	€ 10,00



## FLESS GAS 1/2 x 1/2 IN GOMMA

CODICE	DESCRIZIONE	CF	M.V.	PREZZO
04691 0050	cm 50	1	1	€ 8,70
04691 0070	cm 70	1	1	€ 9,00
04691 0100	cm 100	1	1	€ 11,20



## TUBO FLESSIBILE GAS CON GUAINA ISOLANTE

CODICE	DESCRIZIONE	CF	M.V.	PREZZO
04692 0750	F 1/2 x F 1/2 - 750 MM	12	1	€ 16,70
04692 1000	F 1/2 x F 1/2 - 1000 MM	12	1	€ 17,80
04692 1500	F 1/2 x F 1/2 - 1500 MM	12	1	€ 20,85
04692 2000	F 1/2 x F 1/2 - 2000 MM	12	1	€ 24,56
04692 3000	F 1/2 x F 1/2 - 3000 MM	12	1	€ 35,10
04692 4000	F 1/2 x F 1/2 - 4000 MM	12	1	€ 43,80

## KIT 5 FLESSIBILI ACCIAIO PER CALDAIE

CODICE	DESCRIZIONE	CF	M.V.	PREZZO
04601 0000	5 flessibili	1	1	41,25

COMPOSTO DA:

- 1/2 x 1/2 cm 20/40 pz.2
- 3/4 x 3/4 cm 20/40 pz 2
- 3/4 x 3/4 cm 20/40 GAS pz 1



## FLESSIBILE ACCIAIO PER GAS

CODICE	DESCRIZIONE	CF	M.V.	PREZZO
04696 0420	110/200 1/2	10	1	€ 10,50
04696 0440	220/400 1/2	10	1	€ 11,00
04696 0520	110/200 3/4	10	1	€ 11,70
04696 0540	220/400 3/4	10	1	€ 14,20
04696 0620	110/200 1"	10	1	€ 23,00
04696 0640	220/400 1"	10	1	€ 26,00



## TUBO FLESSIBILE INOX PER GAS

CODICE	DESCRIZIONE	CF	M.V.	PREZZO
04694 0400	1/2	5	5	€ 16,50
04694 0500	3/4	5	5	€ 21,90



## DADO OTTONE CROMATO PER TUBO FLESS INOX GAS

CODICE	DESCRIZIONE	CF	M.V.	PREZZO
04606 0400	1/2	10	10	€ 1,85
04606 0500	3/4	10	10	€ 2,65





## FLESSIBILE ACCIAIO PER CONTATORE GAS

CODICE	DESCRIZIONE	CF	M.V.	PREZZO
04698 0605	F 1" x F 3/4	1	1	€ 20,50



## FLESSIBILE ACCIAIO PER ACQUA

CODICE	DESCRIZIONE	CF	M.V.	PREZZO
04600 0420	110/200 1/2	10	1	€ 7,50
04600 0440	220/400 1/2	10	1	€ 8,13
04600 0520	110/200 3/4	10	1	€ 11,80
04600 0540	220/400 3/4	10	1	€ 12,00
04600 0620	110/200 1"	10	1	€ 15,90
04600 0640	220/400 1"	10	1	€ 20,10



## FLESSIBILE ACCIAIO RIVESTITO PER ACQUA E GAS

CODICE	DESCRIZIONE	CF	M.V.	PREZZO
04603 0420	110/200 1/2	10	1	€ 9,82
04603 0440	220/400 1/2	10	1	€ 11,22
04603 0520	110/200 3/4	10	1	€ 14,52
04603 0540	220/400 3/4	10	1	€ 16,25

- Omologato anche per gas.



## TUBO FLESSIBILE INOX

CODICE	DESCRIZIONE	CF	M.V.	*PREZZO
04602 0400	1/2	5	5	€ 10,75
04602 0500	3/4	5	5	€ 14,63
04602 0600	1"	4	4	€ 24,20

\* Prezzo riferito al metro



## DADO OTTONE CROMATO PER TUBO FLESS INOX

CODICE	DESCRIZIONE	CF	M.V.	PREZZO
04604 0400	1/2	10	10	€ 1,58
04604 0500	3/4	10	10	€ 2,15
04604 0600	1"	10	10	€ 4,00

- Completi di guarnizioni

## GALLEGGIANTE A 5 COPPIGLIE

CODICE	DESCRIZIONE	CF	M.V.	PREZZO
04700 0300	3/8	1	1	€ 12,55
04700 0400	1/2"	1	1	€ 14,10



## GALLEGGIANTE A 5 COPPIGLIE

CODICE	DESCRIZIONE	CF	M.V.	PREZZO
04702 0500	3/4	1	1	€ 17,50
04702 0600	1"	1	1	€ 24,50
04702 0700	1" 1/4	1	1	€ 57,10
04702 0800	1 - 1/2	1	1	€ 69,10
04702 0900	2"	1	1	€ 99,55



## GALLEGGIANTE INGLESE

CODICE	DESCRIZIONE	CF	M.V.	PREZZO
04704 0400	1/2	1	1	€ 16,80
04704 0500	3/4	1	1	€ 18,50
04704 0600	1"	1	1	€ 27,10



## GALLEGGIANTE REGOLABILE ALTA PRESSIONE

CODICE	DESCRIZIONE	CF	M.V.	PREZZO
04706 0500	3/4	1	1	€ 50,00
04706 0600	1"	1	1	€ 50,00
04706 0700	1 - 1/4	1	1	€ 76,30





## GALLEGGIANTE ALTA PRESSIONE CHOPPER

CODICE	DESCRIZIONE	CF	M.V.	PREZZO
05561 7004	1/2	1	1	€ 13,90

- Galleggiante a membrana.
- Si consiglia l'installazione abbinata all'articolo 08915 0400.



## RUBINETTO A GALLEGGIANTE PER ALTE PORTATE

CODICE	DESCRIZIONE	CF	M.V.	PREZZO
04708 0400	1/2	1	1	€ 89,70
04708 0500	3/4	1	1	€ 98,66
04708 0600	1"	1	1	€ 107,64
04708 0700	1 - 1/4	1	1	€ 121,99
04708 0800	1 - 1/2	1	1	€ 172,20

- Con differenziale di riempimento regolabile da cm 5 a cm 250.



**FARG**

## GALLEGGIANTE SILENZIOSO REGOLABILE

CODICE	DESCRIZIONE	CF	M.V.	PREZZO
04709 0400	1/2	1	1	€ 30,00
04709 0500	3/4	1	1	€ 33,50
04709 0600	1"	1	1	€ 36,30
04709 0700	1" - 1/4	1	1	€ 102,18



**FARG**

## GALLEGGIANTE TIPO CATIS

CODICE	DESCRIZIONE	CF	M.V.	PREZZO
04711 0300	3/8	1	1	€ 10,56
04711 0400	1/2	1	1	€ 12,90



## GALLEGGIANTE SAGOMATO

CODICE	DESCRIZIONE	CF	M.V.	PREZZO
04710 0300	3/8	1	1	€ 12,70



## RUBINETTO ATTACCO BASSO PER CASSETTA

CODICE	DESCRIZIONE	CF	M.V.	PREZZO
04712 0300	3/8	1	1	€ 22,24
04712 0400	1/2	1	1	€ 23,34



## COPPIGLIE PER GALLEGGIANTE

CODICE	DESCRIZIONE	CF	M.V.	PREZZO
04715 0000	2,5 x 2,7	1	1	€ 0,18



## SFERA RAME TONDA

CODICE	DESCRIZIONE	CF	M.V.	PREZZO
04720 0000	90	1	1	€ 14,70



## E14 - SFERE GALLEGGIANTI



### SFERA GALLEGGIANTE A 5 COPPIGLIE

CODICE	DESCRIZIONE	CF	M.V.	PREZZO
04722 0120	120	1	1	€ 3,78
04722 0150	150	1	1	€ 4,74
04722 0180	180	1	1	€ 6,75
04722 0220	220	1	1	€ 19,93



### SFERA GALLEGGIANTE INGLESE

CODICE	DESCRIZIONE	CF	M.V.	PREZZO
04724 0120	120	1	1	€ 2,95
04724 0150	150	1	1	€ 5,15



### SFERA PLASTICA PIATTA

CODICE	DESCRIZIONE	CF	M.V.	PREZZO
04726 0090	90 piatta	1	1	€ 1,27



### SFERA PLASTICA TONDA

CODICE	DESCRIZIONE	CF	M.V.	PREZZO
04728 0090	90 tonda	1	1	€ 2,27

## CONTATORE USF A SECCO 8 RULLI

CODICE	DESCRIZIONE	CF	M.V.	PREZZO
04740 0004	1/2	1	1	€ 35,55
04740 0005	3/4	1	1	€ 50,05



## CODOLO OTTONE SEDE PIANA MF X CONTATORE

CODICE	DESCRIZIONE	CF	M.V.	PREZZO
05114 0405	1/2 x 3/4	10	1	€ 4,60



## CASSETTA LAMIERA ZINCATA GAS

CODICE	DESCRIZIONE	CF	M.V.	PREZZO
04610 0000	45 x 34 x 23	3	1	€ 37,90



## CASSETTA LAMIERA ZINCATA ACQUA

CODICE	DESCRIZIONE	CF	M.V.	PREZZO
04612 0000	35 x 45 x 15	2	1	€ 31,50



## CHIAVE UNIVERSALE PER SPORTELLI CONTATORE

CODICE	DESCRIZIONE	CF	M.V.	PREZZO
04614 0000	--	1	1	€ 6,25



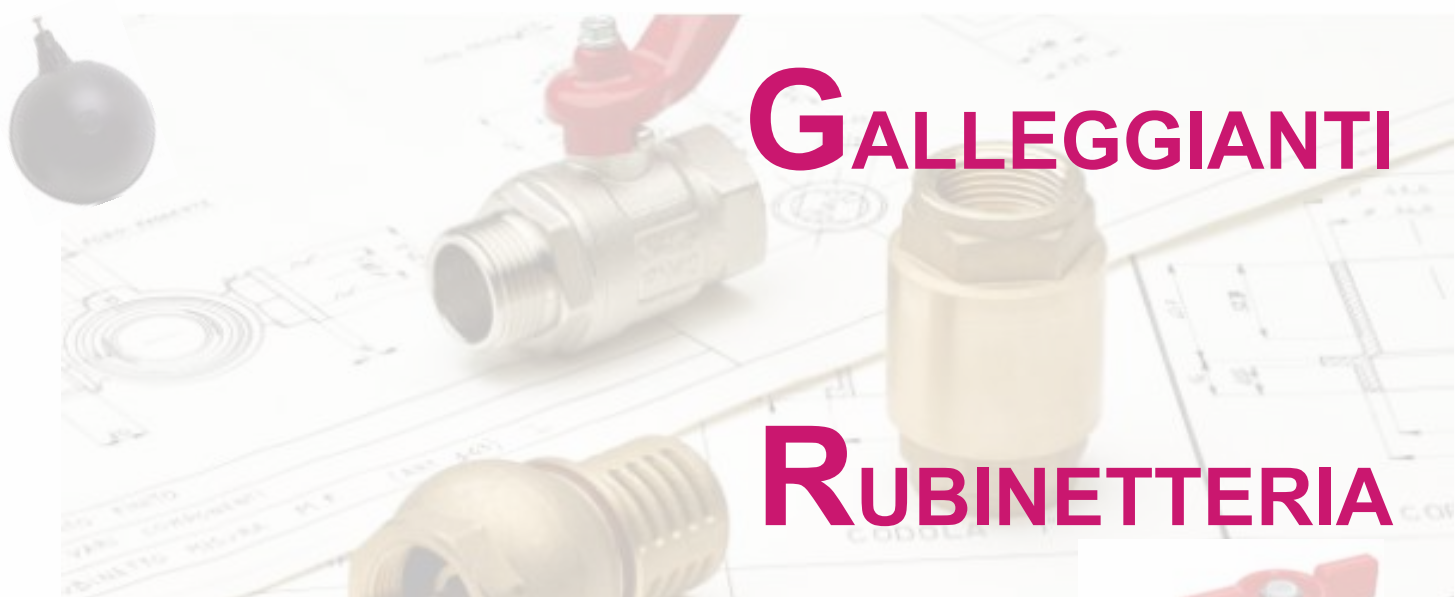

**GALLEGGIANTI**

**RUBINETTERIA**



Rubinetteria Metella Giovanni  
*evolution*



**VALVOLE A SFERA**



**FLESSIBILI ACCIAIO**



**REGOLATORI GAS**



**CONTATORI ACQUA**

OTTONE  
GHISA  
MULTISTRATO  
ZINCATO  
PPR  
POLIETILENE

*Solo quando è abbastanza buio,  
si possono vedere le stelle.*

*Martin Luter King*



**VALVOLE RITEGNO IN OTTONE**



**RACCORDI IN OTTONE**



**MULTISTRATO**



**ZINCATO**



**P<sub>PR</sub>**



**POLIETILENE**



**SERBATOI POLIETILENE**

## VALVOLA RITEGNO F/F C/INSERTO IN OTTONE TIPO PESANTE

CODICE	DESCRIZIONE	CF	M.V.	PREZZO
05040 0400	1/2	35	1	€ 10,50
05040 0500	3/4	25	1	€ 13,40
05040 0600	1"	15	1	€ 19,90
05040 0700	1 - 1/4	10	1	€ 32,56
05040 0800	1 - 1/2	6	1	€ 39,39
05040 0900	2"	3	1	€ 68,90
05040 1000	2 - 1/2	1	1	€ 151,31
05040 1100	3"	1	1	€ 240,24
05040 1200	4"	1	1	€ 314,16



**APM**

## VALVOLA RITEGNO F/F C/INSERTO IN PLASTICA

CODICE	DESCRIZIONE	CF	M.V.	PREZZO
05041 0400	1/2	1	1	€ 7,00
05041 0500	3/4	1	1	€ 9,50
05041 0600	1"	1	1	€ 12,60



## VALVOLA RITEGNO IN ACCIAIO INOX 316

CODICE	DESCRIZIONE	CF	M.V.	PREZZO
05043 0400	1/2	1	1	€ 23,70
05043 0500	3/4	1	1	€ 29,00
05043 0600	1"	1	1	€ 37,00
05043 0700	1 - 1/4	1	1	€ 45,00

- Tenuta P.T.F.E.



**XPOWER**  
WATER - FLUIDS

**New**

## VALVOLA CLAPET SEDE IN GOMMA

CODICE	DESCRIZIONE	CF	M.V.	PREZZO
05050 0400	1/2	30	1	€ 9,80
05050 0500	3/4	20	1	€ 12,71
05050 0600	1"	15	1	€ 19,13
05050 0700	1 - 1/4	8	1	€ 27,61
05050 0800	1 - 1/2	4	1	€ 34,89
05050 0900	2"	2	1	€ 51,85
05050 1000	2 - 1/2	1	1	€ 105,33



**APM**



## FILTRO IN ACCIAIO INOX CON RACCORDO IN NYLON

CODICE	DESCRIZIONE	CF	M.V.	PREZZO
05060 0400	1/2	70	1	€ 2,42
05060 0500	3/4	45	1	€ 2,42
05060 0600	1"	20	1	€ 2,92
05060 0700	1 - 1/4	24	1	€ 4,10
05060 0800	1 - 1/2	15	1	€ 4,69
05060 0900	2"	8	1	€ 5,85



## VALVOLA FONDO IN OTTONE, TENUTA IN GOMMA

CODICE	DESCRIZIONE	CF	M.V.	PREZZO
05070 0500	3/4	35	1	€ 9,14
05070 0600	1"	15	1	€ 12,70
05070 0700	1 - 1/4	9	1	€ 19,85
05070 0800	1 - 1/2	6	1	€ 25,00
05070 0900	2"	5	1	€ 39,75

- Doppia guida



## FILTRO OTTONE C/RETE AD Y

CODICE	DESCRIZIONE	CF	M.V.	PREZZO
05044 0400	1/2	30	1	€ 6,40
05044 0500	3/4	20	1	€ 10,50
05044 0600	1"	20	1	€ 14,60
05044 0700	1 - 1/4	7	1	€ 28,78
05044 0800	1 - 1/2	5	1	€ 35,00
05044 0900	2"	3	1	€ 62,50



## ATTACCO PER SERBATOIO

CODICE	DESCRIZIONE	CF	M.V.	PREZZO
06844 0400	1/2"	10	1	€ 5,60
06844 0500	3/4"	10	1	€ 5,04
06844 0600	1"	10	1	€ 6,17
06844 0700	1"1/2	10	1	€ 10,04
06844 0800	2"	10	1	€ 13,91

## RACCORDO PER CASSONE

CODICE	DESCRIZIONE	CF	M.V.	PREZZO
05102 0400	1/2	5	1	€ 5,78
05102 0500	3/4	5	1	€ 7,80
05102 0600	1"	5	1	€ 9,90
05102 0700	1 - 1/4	2	1	€ 14,90



## RACCORDO PER CASSONE C/CODOLO

CODICE	DESCRIZIONE	CF	M.V.	PREZZO
05104 0400	1/2	1	1	€ 8,90
05104 0500	3/4	1	1	€ 13,00
05104 0600	1"	1	1	€ 17,90
05104 0700	1 - 1/4	1	1	€ 24,50
05104 0800	1 - 1/2	1	1	€ 32,50
05104 0900	2"	1	1	€ 32,50



## CONTRODADO IN OTTONE C/FLANGIA

CODICE	DESCRIZIONE	CF	M.V.	PREZZO
05200 0300	3/8	10	1	€ 1,55
05200 0400	1/2	10	1	€ 1,75
05200 0500	3/4	10	1	€ 1,75
05200 0600	1"	10	1	€ 2,60
05200 0700	1 - 1/4	5	1	€ 3,75
05200 0800	1 - 1/2	1	1	€ 5,95
05200 0900	2"	1	1	€ 8,42



## CODOLO OTTONE SEDE PIANA MF

CODICE	DESCRIZIONE	CF	M.V.	PREZZO
05112 0405	1/2 x 3/4	10	1	€ 3,50
05112 0506	3/4 x 1"	10	1	€ 4,35
05112 0607	1" x 1-1/4	5	1	€ 6,50
05112 0809	1-1/2 x 2"	1	1	€ 20,60



## F2 - RACCORDI IN OTTONE



### CODOLO IN OTTONE SEDE PIANA 1/2

CODICE	DESCRIZIONE	CF	M.V.	PREZZO
05112 0404	1/2 x 1/2	10	1	€ 4,18



### KIT BOCCHETTONI PER CIRCOLATORE

CODICE	DESCRIZIONE	CF	M.V.	* PREZZO
09484 0705	1-1/4 x 3/4 FF	1	1	€ 10,00
09484 0806	1-1/2 x 1" FF	1	1	€ 10,00
09484 0907	1" x 1-1/4 FF	1	1	€ 16,00

\* Il prezzo si riferisce alla coppia



### R18 RACCORDO DIRITTO IN TRE PEZZI FEMMINA-MASCHIO IN OTTONE

CODICE	DESCRIZIONE	CF	M.V.	PREZZO
05156 0400	1/2	10	1	€ 4,85
05156 0500	3/4	10	1	€ 7,69
05156 0600	1"	10	1	€ 13,23
05156 0700	1 - 1/4	5	1	€ 16,80



### CODOLO OTTONE CROMATO CURVO PER SCALDABAGNO

CODICE	DESCRIZIONE	CF	M.V.	PREZZO
05317 0404	1/2 x 1/2	1	1	€ 7,60
05317 0504	3/4 x 1/2	1	1	€ 6,50

## MANICOTTO OTTONE GIALLO FF

CODICE	DESCRIZIONE	CF	M.V.	PREZZO
05210 0200	1/4	10	1	€ 1,84
05210 0300	3/8	10	1	€ 2,45
05210 0400	1/2	10	1	€ 2,25
05210 0500	3/4	10	1	€ 2,83
05210 0600	1"	5	1	€ 5,03
05210 0700	1-1/4	5	1	€ 7,98
05210 0800	1-1/2	5	1	€ 8,05
05210 0900	2"	5	1	€ 12,42



## PROLUNGA OTTONE GIALLO MF

CODICE	DESCRIZIONE	CF	M.V.	PREZZO
05212 0310	3/8 x 1 cm	10	1	€ 1,47
05212 0320	3/8 x 2 cm	10	1	€ 2,03
05212 0410	1/2 x 1 cm	10	1	€ 1,77
05212 0415	1/2" x 1,5 cm	10	1	€ 2,08
05212 0420	1/2 x 2 cm	10	1	€ 2,46
05212 0425	1/2 x 2,5	10	1	€ 2,84
05212 0430	1/2 x 3 cm	10	1	€ 3,15
05212 0440	1/2 x 4 cm	10	1	€ 4,83
05212 0450	1/2 x 5 cm	10	1	€ 5,27
05212 0510	3/4 x 1 cm	5	1	€ 3,66
05212 0520	3/4 x 2 cm	5	1	€ 4,49
05212 0530	3/4 x 3 cm	5	1	€ 5,72
05212 0540	3/4 x 4 cm	5	1	€ 6,60
05212 0550	3/4 x 5 cm	5	1	€ 7,50
05212 0610	1" x 1 cm	5	1	€ 6,60
05212 0620	1" x 2 cm	5	1	€ 7,13
05212 0630	1" x 3 cm	5	1	€ 8,47
05212 0640	1" x 4 cm	5	1	€ 9,02
05212 0650	1" x 5 cm	5	1	€ 12,65



## MANICOTTO RIDOTTO OTTONE GIALLO FF

CODICE	DESCRIZIONE	CF	M.V.	PREZZO
05214 0302	3/8 x 1/4	10	1	€ 2,37
05214 0402	1/2 x 1/4	10	1	€ 3,12
05214 0403	1/2 x 3/8	10	1	€ 2,86
05214 0504	3/4 x 1/2	10	1	€ 2,86
05214 0604	1" x 1/2	10	1	€ 3,83
05214 0605	1" x 3/4	10	1	€ 3,83
05214 0706	1-1/4 x 1"	10	1	€ 7,70
05214 0806	1-1/2 x 1"	5	1	€ 10,00



## F3 - RACCORDI IN OTTONE GIALLO



### MANICOTTO RIDOTTO OTTONE GIALLO FM

CODICE	DESCRIZIONE	CF	M.V.	PREZZO
05218 0302	3/8 x 1/4	10	1	€ 2,11
05218 0402	1/2 x 1/4	10	1	€ 3,10
05218 0403	1/2 x 3/8	10	1	€ 2,02
05218 0504	3/4 x 1/2	10	1	€ 2,45
05218 0605	1" x 3/4	10	1	€ 3,97
05218 0604	1 x 1/2	10	1	€ 4,07
05218 0704	1 - 1/4 x 1/2	5	1	€ 4,94
05218 0706	1 - 1/4 x 1"	5	1	€ 5,75
05218 0806	1- 1/2 x 1"	5	1	€ 7,46



### GOMITO OTTONE GIALLO FF

CODICE	DESCRIZIONE	CF	M.V.	PREZZO
05220 0200	1/4	10	1	€ 3,61
05220 0300	3/8	10	1	€ 2,90
05220 0400	1/2	10	1	€ 3,57
05220 0500	3/4	10	1	€ 4,23
05220 0600	1"	5	1	€ 7,78
05220 0700	1-1/4	5	1	€ 12,36
05220 0800	1-1/2	5	1	€ 18,02
05220 0900	2"	5	1	€ 27,00



### GOMITO OTTONE GIALLO MF

CODICE	DESCRIZIONE	CF	M.V.	PREZZO
05222 0200	1/4	10	1	€ 3,81
05222 0300	3/8	10	1	€ 2,97
05222 0400	1/2	10	1	€ 3,67
05222 0500	3/4	10	1	€ 5,38
05222 0600	1"	5	1	€ 7,89
05222 0700	1-1/4	5	1	€ 11,97
05222 0800	1-1/2	5	1	€ 16,70
05222 0900	2"	5	1	€ 28,60



### GOMITO OTTONE GIALLO 45° FF

CODICE	DESCRIZIONE	CF	M.V.	PREZZO
05224 0400	1/2	10	1	€ 9,70
05224 0500	3/4	10	1	€ 10,92
05224 0600	1"	10	1	€ 12,37

## GOMITO OTTONE GIALLO C/FLANGIA FF

CODICE	DESCRIZIONE	CF	M.V.	PREZZO
05226 0400	½	10	1	€ 5,72



## GOMITO OTTONE GIALLO FF RIDOTTO

CODICE	DESCRIZIONE	CF	M.V.	PREZZO
05228 0403	½ x 3/8	10	1	€ 3,15
05228 0504	¾ x ½	10	1	€ 4,79
05228 0605	1" x ¾	10	1	€ 9,92



## NIPPLES OTTONE GIALLO

CODICE	DESCRIZIONE	CF	M.V.	PREZZO
05230 0100	1/8	10	1	€ 2,28
05230 0200	1/4	10	1	€ 0,93
05230 0300	3/8	10	1	€ 1,38
05230 0400	1/2	10	1	€ 1,39
05230 0500	¾	10	1	€ 2,04
05230 0600	1"	5	1	€ 3,58
05230 0700	1-1/4	5	1	€ 7,13
05230 0800	1-1/2	5	1	€ 7,65
05230 0900	2"	5	1	€ 13,23



## NIPPLES RIDOTTO OTTONE GIALLO

CODICE	DESCRIZIONE	CF	M.V.	PREZZO
05232 0102	1/8x1/4	10	1	€ 1,27
05232 0203	1/4x3/8	10	1	€ 1,73
05232 0402	1/2x1/4	10	1	€ 1,68
05232 0403	1/2x3/8	10	1	€ 1,37
05232 0504	¾x1/2	10	1	€ 2,31
05232 0604	1"x1/2	10	1	€ 3,51
05232 0605	1"x3/4	10	1	€ 3,73
05232 0706	1-1/4x1"	5	1	€ 5,85
05232 0806	1-1/2x1"	5	1	€ 7,88
05232 0807	1-1/2x1-1/4	5	1	€ 8,04



## F3 - RACCORDI IN OTTONE GIALLO



### TRONCHETTO OTTONE GIALLO

CODICE	DESCRIZIONE	CF	M.V.	PREZZO
05236 0405	1/2" x 50 mm	10	1	€ 2,65
05236 0410	1/2" x 100 mm	10	1	€ 4,97
05236 0415	1/2" x 150 mm	10	1	€ 7,61
05236 0420	1/2" x 200 mm	10	1	€ 10,70
05236 0505	3/4" x 50 mm	10	1	€ 3,64
05236 0510	3/4" x 100 mm	10	1	€ 7,28
05236 0515	3/4" x 150 mm	10	1	€ 11,25
05236 0520	3/4" x 200 mm	10	1	€ 14,89
05236 0610	1" x 100 mm	5	1	€ 9,48
05236 0615	1" x 150 mm	5	1	€ 14,67
05236 0620	1" x 200 mm	5	1	€ 19,30



### RIDUZIONE OTTONE GIALLO MF

CODICE	DESCRIZIONE	CF	M.V.	PREZZO
05242 0201	1/4x1/8	10	1	€ 1,70
05242 0302	3/8x1/4	10	1	€ 1,70
05242 0402	1/2x1/4	10	1	€ 1,70
05242 0403	1/2x3/8	10	1	€ 1,23
05242 0504	3/4x1/2	10	1	€ 1,47
05242 0603	1"x3/8	10	1	€ 4,48
05242 0604	1"x1/2	10	1	€ 3,99
05242 0605	1"x3/4	10	1	€ 2,40
05242 0706	1-1/4x1"	5	1	€ 4,39
05242 0806	1-1/2x1"	5	1	€ 7,22
05242 0807	1-1/2x1-1/4	5	1	€ 13,32
05242 0906	2"x1"	5	1	€ 13,32
05242 0907	2"x1-1/4	5	1	€ 9,61
05242 0908	2"x1-1/2	5	1	€ 9,61



**New**

### GHIERA DI RIDUZIONE OTTONE GIALLO SENZA BATTUTA

CODICE	DESCRIZIONE	CF	M.V.	PREZZO
05244 0403	1/2x3/8	10	1	€ 1,34
05244 0504	3/4x1/2	10	1	€ 1,61
05244 0605	1"x3/4	10	1	€ 2,34



### TES OTTONE GIALLO FFF RIDOTTA

CODICE	DESCRIZIONE	CF	M.V.	PREZZO
05258 0504	3/4 x 1/2 x 3/4	10	1	€ 7,28
05258 0604	1" x 1/2 x 1"	10	1	€ 11,76
05258 0605	1" x 3/4 x 1"	10	1	€ 11,03

## TES OTTONE GIALLO FFF

CODICE	DESCRIZIONE	CF	M.V.	PREZZO
05250 0200	1/4	10	1	€ 3,82
05250 0300	3/8	10	1	€ 3,26
05250 0400	1/2	10	1	€ 3,68
05250 0500	3/4	10	1	€ 5,10
05250 0600	1"	5	1	€ 8,31
05250 0700	1-1/4	5	1	€ 14,37
05250 0800	1-1/2	5	1	€ 18,74
05250 0900	2"	5	1	€ 25,19



## TES OTTONE GIALLO MMM

CODICE	DESCRIZIONE	CF	M.V.	PREZZO
05252 0400	1/2	10	1	€ 6,30
05252 0500	3/4	10	1	€ 8,01



## TAPPO OTTONE GIALLO F

CODICE	DESCRIZIONE	CF	M.V.	PREZZO
05260 0200	1/4	10	1	€ 1,14
05260 0300	3/8	10	1	€ 1,23
05260 0400	1/2	10	1	€ 1,10
05260 0500	3/4	10	1	€ 1,50
05260 0600	1"	10	1	€ 2,16
05260 0700	1 - 1/4	10	1	€ 4,11



## TAPPO OTTONE GIALLO M

CODICE	DESCRIZIONE	CF	M.V.	PREZZO
05262 0100	1/8	10	1	€ 1,35
05262 0200	1/4	10	1	€ 1,23
05262 0300	3/8	10	1	€ 1,42
05262 0400	1/2	10	1	€ 0,89
05262 0500	3/4	10	1	€ 1,81
05262 0600	1"	10	1	€ 2,73
05262 0700	1-1/4	5	1	€ 6,20
05262 0800	1-1/2	5	1	€ 6,14
05262 0900	2"	5	1	€ 11,79



# F4 - RACCORDI IN OTTONE CROMATO



## MANICOTTO OTTONE CROMATO FF

CODICE	DESCRIZIONE	CF	M.V.	PREZZO
05310 0300	3/8	10	1	€ 2,11
05310 0400	1/2	10	1	€ 2,81
05310 0500	3/4	10	1	€ 3,76



## PROLUNGA OTTONE CROMATO MF

CODICE	DESCRIZIONE	CF	M.V.	PREZZO
05312 0310	3/8 x 1 cm	10	1	€ 1,80
05312 0320	3/8 x 2 cm	10	1	€ 2,29
05312 0410	1/2 x 1 cm	10	1	€ 2,03
05312 0415	1/2 x 1,5 cm	10	1	€ 2,36
05312 0420	1/2 x 2 cm	10	1	€ 3,19
05312 0425	1/2 x 2,5 cm	10	1	€ 3,38
05312 0430	1/2 x 3 cm	10	1	€ 3,78
05312 0450	1/2 x 5 cm	10	1	€ 6,03
05312 0460	1/2 x 6 cm	10	1	€ 7,12
05312 0470	1/2 x 7 cm	10	1	€ 7,40
05312 0480	1/2 x 8 cm	10	1	€ 9,66
05312 0499	1/2 x 10 cm	10	1	€ 12,90
05312 0510	3/4 x 1 cm	10	1	€ 4,77
05312 0520	3/4 x 2 cm	10	1	€ 5,67
05312 0530	3/4 x 3 cm	10	1	€ 5,95



## MANICOTTO RIDOTTO OTTONE CROMATO FF

CODICE	DESCRIZIONE	CF	M.V.	PREZZO
05314 0403	1/2 x 3/8	10	1	€ 3,68
05314 0504	3/4 x 1/2	10	1	€ 3,83
05314 0605	1" x 3/4	10	1	€ 4,48



## MANICOTTO RIDOTTO OTTONE CROMATO FM

CODICE	DESCRIZIONE	CF	M.V.	PREZZO
05318 0403	1/2 x 3/8	10	1	€ 2,58
05318 0504	3/4 x 1/2	10	1	€ 3,48
05318 0605	1" x 3/4	10	1	€ 6,41

# F4 - RACCORDI IN OTTONE CROMATO

## GOMITO OTTONE CROMATO FF

CODICE	DESCRIZIONE	CF	M.V.	PREZZO
05320 0300	3/8	10	1	€ 3,71
05320 0400	1/2	10	1	€ 3,92
05320 0500	3/4	10	1	€ 4,57



## GOMITO OTTONE CROMATO MF

CODICE	DESCRIZIONE	CF	M.V.	PREZZO
05322 0300	3/8	10	1	€ 3,78
05322 0400	1/2	10	1	€ 3,45
05322 0500	3/4	10	1	€ 5,20



## NIPPLES OTTONE CROMATO

CODICE	DESCRIZIONE	CF	M.V.	PREZZO
05330 0300	3/8	10	1	€ 1,50
05330 0400	1/2	10	1	€ 1,50
05330 0500	3/4	10	1	€ 2,52



## NIPPLES RIDOTTO OTTONE CROMATO

CODICE	DESCRIZIONE	CF	M.V.	PREZZO
05332 0403	1/2x3/8	10	1	€ 1,66
05332 0504	3/4x1/2	10	1	€ 2,73
05332 0605	1"x3/4	10	1	€ 4,70



## CODOLO OTTONE CROMATO SEDE PIANA MF

CODICE	DESCRIZIONE	CF	M.V.	PREZZO
05316 0404	1/2 x 1/2	1	1	€ 5,22



## F4 - RACCORDI IN OTTONE CROMATO



### TES OTTONE CROMATO FFF

CODICE	DESCRIZIONE	CF	M.V.	PREZZO
05350 0300	3/8	10	1	€ 4,13
05350 0400	1/2	10	1	€ 4,13
05350 0500	3/4	10	1	€ 6,36



### RIDUZIONE OTTONE CROMATO MF

CODICE	DESCRIZIONE	CF	M.V.	PREZZO
05342 0403	1/2x3/8	10	1	€ 1,40
05342 0504	3/4x1/2	10	1	€ 1,93
05342 0604	1"x1/2	10	1	€ 3,91
05342 0605	1"x3/4	10	1	€ 3,91



**New**

### GHIERA DI RIDUZIONE OTTONE NICHELATO

CODICE	DESCRIZIONE	CF	M.V.	PREZZO
05344 0403	1/2x3/8	10	1	€ 2,42
05344 0504	3/4x1/2	10	1	€ 2,68
05344 0605	1"x3/4	10	1	€ 3,07



### TAPPO OTTONE CROMATO F

CODICE	DESCRIZIONE	CF	M.V.	PREZZO
05360 0300	3/8	10	1	€ 1,47
05360 0400	1/2	10	1	€ 1,53
05360 0500	3/4	10	1	€ 2,63
05360 0600	1"	10	1	€ 2,94



### TAPPO OTTONE CROMATO M

CODICE	DESCRIZIONE	CF	M.V.	PREZZO
05362 0200	1/4	10	1	€ 1,61
05362 0300	3/8	10	1	€ 1,40
05362 0400	1/2	10	1	€ 1,45
05362 0500	3/4	10	1	€ 2,36
05362 0600	1"	10	1	€ 3,87

## MANICOTTI

CODICE	DESCRIZIONE	Misura	CF	M.V.	PREZZO
05410 0400	Manicotti	½	10	1	€ 1,29
05410 0500		¾	10	1	€ 1,64
05410 0600		1	10	1	€ 2,15
05410 0700		1 1/4	1	1	€ 3,36
05410 0800		1 1/2	1	1	€ 4,87
05410 0900		2	1	1	€ 7,22
05410 1000		2 1/2	1	1	€ 20,00
05410 1100		3	1	1	23,96
05410 1200		4"	1	1	56,05



## MANICOTTI MF

CODICE	DESCRIZIONE	Misura	CF	M.V.	PREZZO
05412 0400	Manicotti MF	½	10	1	€ 2,37
05412 0500		¾	10	1	€ 3,20
05412 0600		1	10	1	€ 5,47
05412 0700		1 1/4	1	1	€ 6,35
05412 0800		1 1/2	1	1	€ 8,33
05412 0900		2	1	1	€ 16,70



## MANICOTTI RIDOTTI FF

CODICE	DESCRIZIONE	Misura	CF	M.V.	PREZZO
05414 0504	Manicotti ridotti FF	¾ X ½	10	1	€ 2,17
05414 0604		1 X ½	10	1	€ 2,67
05414 0605		1 X ¾	10	1	€ 2,44
05414 0706		1 1/4 X 1	5	1	€ 4,60
05414 0806		1 1/2 X 1	5	1	€ 5,21
05414 0807		1 1/2 X 1 1/4	5	1	€ 5,79
05414 0906		2 X 1	5	1	€ 10,32
05414 0907		2 X 1 1/4	1	1	€ 10,07
05414 0908		2 X 1 1/2	1	1	€ 9,62
05414 1009		2 1/2 X 2	1	1	€ 21,44



## MANICOTTI RIDOTTI MF

CODICE	DESCRIZIONE	Misura	CF	M.V.	PREZZO
05418 0504	Manicotti ridotti MF	¾ x ½	10	1	€ 2,44
05418 0604		1 x ½	10	1	€ 3,43
05418 0605		1 x ¾	10	1	€ 3,54
05418 0706		1 1/4 x 1	10	1	€ 5,00





## GOMITI A 90° FF

CODICE	DESCRIZIONE	Misura	CF	M.V.	PREZZO
05420 0400	Gomiti a 90° FF	½	10	1	€ 1,05
05420 0500		¾	10	1	€ 1,67
05420 0600		1	10	1	€ 2,52
05420 0700		1 1/4	10	1	€ 4,70
05420 0800		1 1/2	1	1	€ 7,41
05420 0900		2	1	1	€ 8,90
05420 1000		2 1/2	1	1	€ 26,28
05420 1100		3	1	1	€ 41,00
05420 1200		4"	1	1	€ 63,36



## GOMITI A 90° MF

CODICE	DESCRIZIONE	Misura	CF	M.V.	PREZZO
05422 0400	Gomiti a 90° MF	½	10	1	€ 1,25
05422 0500		¾	10	1	€ 1,88
05422 0600		1	10	1	€ 3,16
05422 0700		1 1/4	10	1	€ 5,32
05422 0800		1 1/2	1	1	€ 9,13
05422 0900		2	1	1	€ 10,81
05422 1000		2 1/2	1	1	€ 26,54
05422 1100		3	1	1	€ 35,74



## CURVE 45° FF

CODICE	DESCRIZIONE	Misura	CF	M.V.	PREZZO
05424 0400	Curve 45° FF	½	10	1	€ 3,73
05424 0500		¾	10	1	€ 4,91
05424 0600		1	10	1	€ 6,47



## GOMITI A 90° RIDOTTI FF

CODICE	DESCRIZIONE	Misura	CF	M.V.	PREZZO
05428 0504	Gomiti a 90° ridotti FF	¾ x ½	10	1	€ 2,23
05428 0604		1 x ½	10	1	€ 3,44
05428 0605		1 x ¾	10	1	€ 3,59
05428 0706		1-1/4 x 1"	10	1	€ 5,26

## NIPPLES

CODICE	DESCRIZIONE	Misura	CF	M.V.	PREZZO
05430 0400	Nipples	1/2	10	1	€ 1,11
05430 0500		3/4	10	1	€ 1,40
05430 0600		1	10	1	€ 2,12
05430 0700		1 1/4	10	1	€ 3,51
05430 0800		1 1/2	1	1	€ 4,05
05430 0900		2	1	1	€ 7,30
05430 1000		2 1/2	1	1	€ 13,16
05430 1100		3	1	1	€ 15,89
05430 1200		4"	1	1	€ 58,67



## NIPPLES RIDOTTI MM

CODICE	DESCRIZIONE	Misura	CF	M.V.	PREZZO
05432 0504	Nipples ridotti MM	3/4 x 1/2	10	1	€ 2,15
05432 0604		1 x 1/2	10	1	€ 3,95
05432 0605		1 x 3/4	10	1	€ 2,51
05432 0706		1 1/4 x 1	10	1	€ 3,98
05432 0806		1 1/2 x 1	1	1	€ 8,41
05432 0807		1 1/2 x 1 1/4	1	1	€ 5,04
05432 0906		2 x 1	1	1	€ 8,27
05432 0907		2 x 1 1/4	1	1	€ 9,93
05432 0908		2 x 1 1/2	1	1	€ 9,48
05432 1009		2 1/2 x 2	1	1	€ 23,75
05432 1109		3 x 2	1	1	€ 27,97
05432 1110		3 x 2 1/2	1	1	€ 38,90



## RIDUZIONI MF

CODICE	DESCRIZIONE	Misura	CF	M.V.	PREZZO
05442 0504	Riduzioni MF	3/4 x 1/2	10	1	€ 1,18
05442 0604		1 x 1/2	10	1	€ 1,85
05442 0605		1 x 3/4	10	1	€ 1,84
05442 0705		1 1/4 x 3/4	10	1	€ 2,71
05442 0706		1 1/4 x 1	10	1	€ 2,49
05442 0806		1 1/2 x 1	10	1	€ 2,93
05442 0807		1 1/2 x 1 1/4	10	1	€ 3,35
05442 0906		2 x 1	5	1	€ 6,79
05442 0907		2 x 1 1/4	5	1	€ 5,77
05442 0908		2 x 1 1/2	5	1	€ 5,36
05442 1007		2 1/2 x 1 1/4	1	1	€ 12,74
05442 1008		2 1/2 x 1 1/2	1	1	€ 14,40
05442 1009		2 1/2 x 2	1	1	€ 10,05
05442 1109		3 x 2	1	1	€ 12,98
05442 1110		3 x 2 1/2	1	1	€ 14,27
05442 1209		4 x 2	1	1	€ 34,61
05442 1211		4 x 3	1	1	€ 26,35



## F5 - RACCORDI IN GHISA TSP



### TI A 90° FF

CODICE	DESCRIZIONE	Misura	CF	M.V.	PREZZO
05450 0400	Ti a 90° FF	½	10	1	€ 1,49
05450 0500		¾	10	1	€ 2,43
05450 0600		1	10	1	€ 3,54
05450 0700		1¼	10	1	€ 6,56
05450 0800		1½	5	1	€ 9,69
05450 0900		2	1	1	€ 13,90
05450 1000		2½	1	1	€ 31,41
05450 1100		3	1	1	€ 43,80
05450 1200		4"	1	1	€ 83,95



### TI A 90° RIDOTTI O MAGGIORATI

CODICE	DESCRIZIONE	Misura	CF	M.V.	PREZZO
05458 0504	Ti a 90° ridotti o maggiorati	¾ x ½ x ¾	10	1	€ 2,70
05458 0604		1 x ½ x 1	10	1	€ 3,89
05458 0605		1 x ¾ x 1	10	1	€ 3,89
05458 0906		2 x 1 x 2	1	1	€ 12,02



### CROCI A 90°

CODICE	DESCRIZIONE	Misura	CF	M.V.	PREZZO
05459 0400	Croci a 90°	½	10	1	€ 4,94
05459 0500		¾	10	1	€ 7,44
05459 0600		1	10	1	€ 9,20
05459 0700		1-¼	1	1	€ 14,07
05459 0900		2"	1	1	€ 29,44



### DISTRIBUZIONE A GOMITO

CODICE	DESCRIZIONE	Misura	CF	M.V.	PREZZO
05429 0400	Distribuzione a gomito	½	10	1	€ 4,64
05429 0500		¾	10	1	€ 6,77
05429 0600		1	10	1	€ 9,46

## CALOTTE ESAGONALI

CODICE	DESCRIZIONE	Misura	CF	M.V.	PREZZO
05460 0400	Calotte esagonali	1/2	10	1	€ 1,49
05460 0500		3/4	10	1	€ 1,59
05460 0600		1	10	1	€ 1,96
05460 0700		1 1/4	10	1	€ 2,89
05460 0800		1 1/2	5	1	€ 3,57
05460 0900		2	1	1	€ 6,85
05460 1000		2 1/2	1	1	€ 12,18
05460 1100		3	1	1	€ 13,59



## TAPPI MASCHIO CON BORDO

CODICE	DESCRIZIONE	Misura	CF	M.V.	PREZZO
05462 0400	Tappi maschi con bordo	1/2	10	1	€ 0,89
05462 0500		3/4	10	1	€ 1,16
05462 0600		1	10	1	€ 1,27
05462 0700		1 1/4	10	1	€ 2,39
05462 0800		1 1/2	5	1	€ 2,93
05462 0900		2	1	1	€ 5,50
05462 1000		2 1/2	1	1	€ 11,41
05462 1100		3	1	1	€ 14,68



## BOCCHETTONI FF A SEDE CONICA

CODICE	DESCRIZIONE	Misura	CF	M.V.	PREZZO
05454 0400	Bocchettoni FF a sede conica	1/2	10	1	€ 5,32
05454 0500		3/4	10	1	€ 6,16
05454 0600		1	10	1	€ 7,18
05454 0700		1 1/4	1	1	€ 11,98
05454 0800		1 1/2	1	1	€ 14,29
05454 0900		2	1	1	€ 23,06
05454 1000		2 1/2	1	1	€ 48,88
05454 1100		3	1	1	€ 70,96



## BOCCHETTONI MF A SEDE CONICA

CODICE	DESCRIZIONE	Misura	M.V.	M.V.	PREZZO
05456 0400	Bocchettoni MF a sede conica	1/2	10	1	€ 5,58
05456 0500		3/4	10	1	€ 6,78
05456 0600		1	10	1	€ 8,45
05456 0700		1 1/4	1	1	€ 13,12
05456 0800		1 1/2	1	1	€ 16,14
05456 0900		2	1	1	€ 25,28
05456 1000		2 1/2	1	1	€ 62,30
05456 1100		3	1	1	€ 86,71





## TRONCHETTO AC ZINCATO SALDATO MM 1/2

CODICE	DESCRIZIONE	CF	M.V.	PREZZO
05404 0100	1/2 x CM 10	10	1	€ 1,81
05404 0150	1/2 x CM 15	10	1	€ 2,37
05404 0200	1/2 x CM 20	10	1	€ 3,10
05404 0300	1/2 x CM 30	10	1	€ 4,91
05404 0400	1/2 x CM 40	10	1	€ 6,38
05404 0500	1/2 x CM 50	10	1	€ 7,54
05404 1000	1/2 x CM 100	10	1	€ 17,46



## TRONCHETTO AC ZINCATO SALDATO MM 3/4

CODICE	DESCRIZIONE	CF	M.V.	PREZZO
05405 0100	3/4 x CM 10	10	1	€ 2,27
05405 0150	3/4 x CM 15	10	1	€ 2,85
05405 0200	3/4 x CM 20	10	1	€ 3,74
05405 0300	3/4 x CM 30	10	1	€ 6,23
05405 0400	3/4 x CM 40	10	1	€ 7,83
05405 0500	3/4 x CM 50	10	1	€ 9,44
05405 1000	3/4 x CM 100	10	1	€ 21,81



## TRONCHETTO AC ZINCATO SALDATO MM 1"

CODICE	DESCRIZIONE	CF	M.V.	PREZZO
05406 0100	1" x CM 10	10	1	€ 3,05
05406 0150	1" x CM 15	10	1	€ 4,02
05406 0200	1" x CM 20	10	1	€ 4,98
05406 0300	1" x CM 30	10	1	€ 8,67
05406 0400	1" x CM 40	10	1	€ 11,60
05406 0500	1" x CM 50	10	1	€ 13,38
05406 1000	1" x CM 100	10	1	€ 31,26



## TRONCHETTO AC ZINCATO SALDATO MM 1"-1/4

CODICE	DESCRIZIONE	CF	M.V.	PREZZO
05407 0100	1"-1/4 x CM 10	10	1	€ 3,94
05407 0150	1"-1/4 x CM 15	10	1	€ 5,54
05407 0200	1"-1/4 x CM 20	10	1	€ 6,72
05407 0300	1"-1/4 x CM 30	10	1	€ 10,95
05407 0400	1"-1/4 x CM 40	10	1	€ 17,40
05407 0500	1"-1/4 x CM 50	10	1	€ 16,77

## TRONCHETTO AC ZINCATO SALDATO MM 1"-1/2

CODICE	DESCRIZIONE	CF	M.V.	PREZZO
05408 0100	1"-1/2 x CM 10	5	1	€ 4,62
05408 0150	1"-1/2 x CM 15	5	1	€ 6,35
05408 0200	1"-1/2 x CM 20	5	1	€ 7,96
05408 0300	1"-1/2 x CM 30	5	1	€ 12,78
05408 0400	1"-1/2 x CM 40	5	1	€ 16,26
05408 0500	1"-1/2 x CM 50	5	1	€ 19,52



## TRONCHETTO AC ZINCATO SALDATO MM 2"

CODICE	DESCRIZIONE	CF	M.V.	PREZZO
05409 0100	2" x CM 10	1	1	€ 6,91
05409 0150	2" x CM 15	1	1	€ 8,30
05409 0200	2" x CM 20	1	1	€ 10,84
05409 0300	2" x CM 30	1	1	€ 17,33
05409 0400	2" x CM 40	1	1	€ 22,65
05409 0500	2" x CM 50	1	1	€ 26,47



## TUBO AC ZINCATO SALDATO V.M. mt. 6

CODICE	DESCRIZIONE	CF	M.V.	PREZZO
05400 0400	1/2	1	1	€ 40,36
05400 0500	3/4	1	1	€ 49,23
05400 0600	1"	1	1	€ 75,73
05400 0700	1 - 1/4	1	1	€ 100,00
05400 0800	1 - 1/2	1	1	€ 111,09
05400 0900	2"	1	1	€ 155,25
05400 1000	2 - 1/2	1	1	€ 202,50
05400 1100	3"	1	1	€ 264,33

- Il PREZZO si riferisce alla canna da 6 mt.



# F7 - RACCORDI DI RIPARAZIONE NICHELATI



## RACCORDO NICHELATO PER TUBO FERRO

CODICE	DESCRIZIONE	CF	M.V.	PREZZO
05502 0300	3/8	10	1	€ 14,72
05502 0400	1/2	5	1	€ 17,91
05502 0500	3/4	5	1	€ 20,50
05502 0600	1"	1	1	€ 28,48
05502 0700	1-1/4	1	1	€ 43,51
05502 0800	1-1/2	1	1	€ 54,88
05502 0900	2"	1	1	€ 88,43



## RACCORDO FEMMINA NICHELATO PER TUBO FERRO

CODICE	DESCRIZIONE	CF	M.V.	PREZZO
05508 0300	3/8	10	1	€ 12,82
05508 0400	1/2	5	1	€ 12,75
05508 0500	3/4	5	1	€ 17,07
05508 0600	1"	1	1	€ 24,33
05508 0700	1-1/4	1	1	€ 40,43
05508 0800	1-1/2	1	1	€ 51,61
05508 0900	2"	1	1	€ 79,53



## RACCORDO MASCHIO NICHELATO PER TUBO FERRO

CODICE	DESCRIZIONE	CF	M.V.	PREZZO
05506 0300	3/8	10	1	€ 10,58
05506 0400	1/2	5	1	€ 10,40
05506 0500	3/4	5	1	€ 13,69
05506 0600	1"	1	1	€ 24,87
05506 0700	1-1/4	1	1	€ 39,36
05506 0800	1-1/2	1	1	€ 48,07
05506 0900	2"	1	1	€ 73,92



## COLLARE DI RIPARAZIONE AD UN TIRANTE

CODICE	DESCRIZIONE	CF	M.V.	PREZZO
06867 0400	21-25 1/2	10	1	€ 16,60
06867 0500	26-30 3/4	10	1	€ 16,70
06867 0600	33-37 1"	10	1	€ 17,00
06867 0700	42-45 1-1/4	10	1	€ 18,00
06867 0800	48-51 1-1/2	10	1	€ 19,00
06867 0900	60-64 2"	10	1	€ 26,00
06867 1100	87-93 3"	10	1	€ 29,00

## TUBO MULTISTRATO NUDO PEX-B

CODICE	DESCRIZIONE	CF	M.V.	PREZZO
05600 0016	16x2 Al. 0,2	100	100	€ 1,45
05600 0020	20x2 Al. 0,2	100	100	€ 2,27
05600 0026	26x3 Al. 0,4	50	50	€ 5,05
05600 0032	32x3 Al. 0,5	50	50	€ 7,24



## TUBO MULTISTRATO COIBENTATO PEX-B BLU

CODICE	DESCRIZIONE	CF	M.V.	PREZZO
05602 0016	16x2 Al. 0,2	700	50	€ 1,84
05602 0020	20x2 Al. 0,2	700	50	€ 2,60
05602 0026	26x3 Al. 0,4	400	50	€ 6,14
05602 0032	32x3 Al. 0,5	400	25	€ 10,46



## TUBO MULTISTRATO COIBENTATO PEX-B ROSSO

CODICE	DESCRIZIONE	CF	M.V.	PREZZO
05603 0016	16x2 Al. 0,2	700	50	€ 1,84
05603 0020	20x2 Al. 0,2	700	50	€ 2,60
05603 0026	26x3 Al. 0,4	400	25	€ 6,14
05603 0032	32x3 Al. 0,5	400	25	€ 10,46



## TUBO MULTISTRATO COIBENTATO PER REFRIGERAZIONE

CODICE	DESCRIZIONE	CF	M.V.	PREZZO
05630 0020	Ø 20	50	50	€ 3,97
05630 0026	Ø 26	25	25	€ 7,88
05630 0032	Ø 32	25	25	€ 11,61



## TUBO MULTISTRATO GUAINATO PER GAS

CODICE	DESCRIZIONE	CF	M.V.	PREZZO
05640 0016	Ø16	50	50	€ 3,26
05640 0020	Ø 20	50	50	€ 4,33
05640 0026	Ø 26	50	50	€ 8,54



# F9 - TUBAZIONI MULTISTRATO GIACOMINI



## R999 - TUBO MULTISTRATO NUDO

CODICE	DESCRIZIONE	CF	M.V.	PREZZO
05700 0016	16X2	100	100	€ 1,96
05700 0020	20X2	100	100	€ 2,81
05700 0026	26X3	50	50	€ 5,90
05700 0032	32X3	50	50	€ 10,15

Tubo multistrato metallo-plastico PEX-b/AL/PEX-b idoneo per impianti sanitari, di riscaldamento e raffrescamento, classi di applicazioni 1, 2, 4 e 5.



## R999I - TUBO MULTISTRATO COIBENTATO

CODICE	DESCRIZIONE	CF	M.V.	PREZZO
05702 0016	16X2 spess. coib. 6 mm	50	50	€ 2,74
05702 0020	20X2 spess. coib. 10 mm	50	50	€ 3,75
05702 0026	26X3 spess. coib. 10 mm	25	25	€ 7,43
05702 0032	32X3 spess. coib. 10 mm	25	25	€ 11,95

Tubo multistrato metallo-plastico PEX-b/AL/PEX-b con coibentazione termica idoneo per impianti sanitari, raffrescamento, classi di applicazioni 1, 2, 4 e 5.

NOTE: spessore coibentazione tubi in riscaldamento 6:10 mm (a seconda del diametro del tubo).



## R999I - TUBO MULTISTRATO COIBENTATO

CODICE	DESCRIZIONE	CF	M.V.	PREZZO
05730 0016	16X2 spess. coib. 10 mm	50	50	€ 3,58
05730 0020	20X2 spess. coib. 13 mm	50	50	€ 5,30
05730 0026	26X3 spess. coib. 13 mm	25	25	€ 9,35
05730 0032	32X3 spess. coib. 13 mm	25	25	€ 14,80

Tubo multistrato metallo-plastico PEX-b/AL/PEX-b con coibentazione termica idoneo per impianti sanitari, di riscaldamento, classi di applicazioni 1, 2, 4 e 5.

NOTE: spessore coibentazione tubi in raffrescamento 10:13 mm (a seconda del diametro del tubo).



## G999 - TUBO MULTISTRATO GUAINATO PER GAS

CODICE	DESCRIZIONE	CF	M.V.	PREZZO
05740 0016	16X2	50	50	€ 4,26
05740 0020	20X2	50	50	€ 5,75
05740 0026	26X3	50	50	€ 9,85

Tubo multistrato metallo-plastico PEX-b/AL/PEX-b serie multigas. Colore giallo. Idoneo per trasporto di gas ad uso domestico con guaina corrugata in bobine di rivestimento giallo.



# F10 - RACCORDI MULTISTRATO A STRINGERE

## RACCORDO DIRITTO DOPPIO

CODICE	DESCRIZIONE	CF	M.V.	PREZZO
05802 1616	16x16	10	1	€ 5,18
05802 2020	20x20	10	1	€ 8,02
05802 2626	26x26	10	1	€ 14,31
05802 3232	32x32	5	1	€ 18,80



## RACCORDO DIRITTO FILETTATO MASCHIO

CODICE	DESCRIZIONE	CF	M.V.	PREZZO
05806 1604	16x1/2	10	1	€ 2,70
05806 1605	16x3/4	10	1	€ 4,32
05806 2004	20x1/2	10	1	€ 4,52
05806 2005	20x3/4	10	1	€ 6,56
05806 2605	26x3/4	10	1	€ 7,97
05806 2606	26x1"	10	1	€ 8,53
05806 3206	32x1"	5	1	€ 12,00



## RACCORDO DIRITTO FILETTATO FEMMINA

CODICE	DESCRIZIONE	CF	M.V.	PREZZO
05808 1604	16x1/2	10	10	€ 3,01
05808 2004	20x1/2	10	10	€ 4,73
05808 2005	20x3/4	10	10	€ 5,51
05808 2605	26x3/4	10	10	€ 8,25
05808 2606	26x1"	10	10	€ 9,73
05808 3206	32x1"	5	5	€ 13,70



# F10 - RACCORDI MULTISTRATO A STRINGERE



## GOMITO INTERMEDIO

CODICE	DESCRIZIONE	CF	M.V.	PREZZO
05820 1616	16x16	10	1	€ 5,65
05820 2020	20x20	10	1	€ 9,80
05820 2626	26x26	5	1	€ 14,00
05820 3232	32x32	5	1	€ 22,00



## GOMITO FILETTATO MASCHIO

CODICE	DESCRIZIONE	CF	M.V.	PREZZO
05822 1604	16x1/2	10	1	€ 4,13
05822 2004	20x1/2	10	1	€ 6,20
05822 2005	20x3/4	10	1	€ 6,20
05822 2605	26x3/4	5	1	€ 9,50
05822 3206	32x1"	5	1	€ 13,30



## GOMITO FILETTATO FEMMINA

CODICE	DESCRIZIONE	CF	M.V.	PREZZO
05823 1604	16x1/2	10	1	€ 4,47
05823 2004	20x1/2	10	1	€ 6,65
05823 2005	20x3/4	10	1	€ 7,23
05823 2605	26x3/4	5	1	€ 10,08
05823 3206	32x1"	5	1	€ 14,70



## GOMITO FILETTATO FEMMINA CON FLANGIA

CODICE	DESCRIZIONE	CF	M.V.	PREZZO
05826 1604	16x1/2	10	1	€ 5,76
05826 2004	20x1/2	10	1	€ 7,02

# F10 - RACCORDI MULTISTRATO A STRINGERE

## RACCORDO A T INTERMEDIO

CODICE	DESCRIZIONE	CF	M.V.	PREZZO
05850 0016	16x16x16	10	1	€ 7,85
05850 0020	20x20x20	10	1	€ 12,56
05850 0026	26x26x26	5	1	€ 19,23
05850 0032	32X32X32	5	1	€ 29,50



## RACCORDO A T FILETTATO FEMMINA

CODICE	DESCRIZIONE	CF	M.V.	PREZZO
05851 1604	16x1/2 F	10	1	€ 6,91
05851 2004	20x1/2 F	10	1	€ 10,71
05851 2005	20x3/4 F	10	1	€ 11,40
05851 2605	26x3/4 F	5	1	€ 18,05
05851 3206	32X1" F	5	1	€ 25,00



# F11 - RACCORDI MULTISTRATO A STRINGERE GIACOMINI



## R187M RACCORDO DIRITTO FILETTATO MASCHIO

CODICE	DESCRIZIONE	CF	M.V.	PREZZO
06104 1604	1/2"X(16X2)	25	1	€ 5,25
06104 1605	3/4"X(16X2)	10	1	€ 6,08
06104 2004	1/2"X(20X2)	25	1	€ 5,40
06104 2005	3/4"X(20X2)	25	1	€ 6,25
06104 2605	3/4"X(26X2)	10	1	€ 9,49
06104 2606	1"X(26X3)	10	1	€ 10,46
06104 3206	1"X(32X3)	10	1	€ 16,03



## R187F RACCORDO DIRITTO FILETTATO FEMMINA

CODICE	DESCRIZIONE	CF	M.V.	PREZZO
06106 1604	1/2"X(16X2)	25	1	€ 5,50
06106 1605	3/4"X(16X2)	10	1	€ 6,17
06106 2004	1/2"X(20X2)	25	1	€ 5,39
06106 2005	3/4"X(20X2)	25	1	€ 6,43
06106 2605	3/4"X(26X2)	10	1	€ 9,01
06106 2606	1"X(26X3)	10	1	€ 12,09
06106 3206	1"X(32X3)	10	1	€ 15,77



## R560M RACCORDO DIRITTO DOPPIO

CODICE	DESCRIZIONE	CF	M.V.	PREZZO
06108 1616	16X16	10	1	€ 9,23
06108 2020	20X20	10	1	€ 9,72
06108 2626	26X26	5	1	€ 17,47
06108 3232	32X32	5	1	€ 28,59



## R564AM RACCORDO A T

CODICE	DESCRIZIONE	CF	M.V.	PREZZO
06150 0016	16X2	10	1	€ 13,74
06150 0020	20X2	10	1	€ 13,74
06150 0026	26X3	10	1	€ 27,92
06150 0032	32X3	5	1	€ 37,85



## R569AM RACCORDO A T FILETTATO FEMMINA

CODICE	DESCRIZIONE	CF	M.V.	PREZZO
06151 1604	1/2"X(16X2)	10	1	€ 10,15
06151 2004	1/2"X(20X2)	10	1	€ 10,98
06151 2605	3/4"X(26X3)	10	1	€ 19,04
06151 3206	1"X(32X3)	5	1	€ 31,62

# F11 - RACCORDI MULTISTRATO A STRINGERE GIACOMINI

## R561AM RACCORDO CURVO 90° FILETTATO

CODICE	DESCRIZIONE	CF	M.V.	PREZZO
06120 1616	16X2	10	1	€ 10,06
06120 2020	20x2	10	1	€ 10,06
06120 2626	26x3	5	1	€ 16,25
06120 3232	32x3	5	1	€ 27,77



## R562AM RACCORDO CURVO 90° FILETTATO MASCHIO

CODICE	DESCRIZIONE	CF	M.V.	PREZZO
06122 1604	1/2"X(16X2)	25	1	€ 6,62
06122 2004	1/2"X(20X2)	10	1	€ 6,84
06122 2005	3/4"X(20x3)	10	1	€ 8,20
06122 2605	3/4"X(26x3)	10	1	€ 10,72
06122 3206	1"X(32x3)	5	1	€ 15,83



## R563AM RACCORDO CURVO 90° FILETTATO FEMMINA

CODICE	DESCRIZIONE	CF	M.V.	PREZZO
06123 1604	1/2"X(16X2)	25	1	€ 7,19
06123 2004	1/2"X(20X2)	10	1	€ 7,76
06123 2005	3/4"X(20x3)	10	1	€ 9,19
06123 2605	3/4"X(26x3)	10	1	€ 10,68
06123 3206	1"X(32x3)	5	1	€ 17,07



## R572AM RACCORDO A GOMITO FILETTATO FEMMINA C/STAFFA A MURO

CODICE	DESCRIZIONE	CF	M.V.	PREZZO
06126 1604	1/2"X(16X2)	10	1	€ 8,35
06126 2004	1/2"X(20X2)	10	1	€ 8,35



# F12 - RACCORDI MULTISTRATO A PRESSARE



## RACCORDO DIRITTO A PRESSARE

CODICE	DESCRIZIONE	CF	M.V.	PREZZO
05902 1616	16x2	10	1	€ 4,51
05902 2020	20x2	10	1	€ 6,00
05902 2626	26x3	5	1	€ 10,00



## RACCORDO DIRITTO RIDOTTO A PRESSARE

CODICE	DESCRIZIONE	CF	M.V.	PREZZO
05904 2016	(20x2) x (16x2)	10	1	€ 7,58
05904 2620	(26x2) x (20x2)	5	1	€ 9,11



## RACCORDO DIRITTO FILETTATO MASCHIO A PRESSARE

CODICE	DESCRIZIONE	CF	M.V.	PREZZO
05906 1604	1/2 x (16x2)	10	1	€ 3,60
05906 2004	1/2 x (20x2)	10	1	€ 4,65
05906 2005	3/4 x (20x2)	5	1	€ 5,37
05906 2605	3/4 x (26x3)	5	1	€ 6,85
05906 2606	1" x (26x3)	5	1	€ 9,31



## RACCORDO DIRITTO FILETTATO FEMMINA A PRESSARE

CODICE	DESCRIZIONE	CF	M.V.	PREZZO
05908 1604	1/2 x (16x2)	10	1	€ 3,20
05908 2004	1/2 x (20x2)	10	1	€ 4,33
05908 2005	3/4 x (20x2)	5	1	€ 5,04
05908 2605	3/4 x (26x3)	5	1	€ 7,20
05908 2606	1" x (26x3)	5	1	€ 8,59

# F12 - RACCORDI MULTISTRATO A PRESSARE

## RACCORDO DIRITTO FILETTATO FEMMINA C/GIRELLO A PRESSARE SEDE PIANA

CODICE	DESCRIZIONE	CF	M.V.	PREZZO
05910 1604	16 x 1/2F	10	1	€ 7,50
05910 2005	20 x 1/2F	10	1	€ 8,50
05910 2004	20 x 3/4F	10	1	€ 10,18



## RACCORDO DIRITTO FILETTATO FEMMINA C/GIRELLO A PRESSARE SEDE PIANA

CODICE	DESCRIZIONE	CF	M.V.	PREZZO
05911 1604	16 x 1/2F*	10	1	€ 7,50

\* Per derivazioni collettori e valvole.



## STAFFA A MURO PER GOMITI A PRESSARE C/STAFFA

CODICE	DESCRIZIONE	CF	M.V.	PREZZO
05927 0000	Interasse 75-150	25	1	€ 4,87

- Staffe a muro con set 6 viti, per articolo 05926.



# F12 - RACCORDI MULTISTRATO A PRESSARE



## GOMITO A PRESSARE

CODICE	DESCRIZIONE	CF	M.V.	PREZZO
05920 1616	16x2	10	1	€ 5,05
05920 2020	20x2	10	1	€ 7,10
05920 2626	26x3	5	1	€ 10,54



## GOMITO FILETTATO MASCHIO A PRESSARE

CODICE	DESCRIZIONE	CF	M.V.	PREZZO
05922 1604	1/2 x (16x2)	10	1	€ 4,58
05922 2004	1/2 x (20x2)	10	1	€ 6,07
05922 2005	3/4 x (20x2)	5	1	€ 7,50
05922 2605	3/4 x (26x3)	5	1	€ 10,43



## GOMITO FILETTATO FEMMINA A PRESSARE

CODICE	DESCRIZIONE	CF	M.V.	PREZZO
05923 1604	1/2 x (16x2)	10	1	€ 3,85
05923 2004	1/2 x (20x2)	10	1	€ 5,66
05923 2005	3/4 x (20x2)	5	1	€ 6,78
05923 2605	3/4 x (26x3)	5	1	€ 9,56



## GOMITO FILETTATO FEMMINA CON STAFFA A PRESSARE

CODICE	DESCRIZIONE	CF	M.V.	PREZZO
05926 1604	1/2 x (16x2)	10	1	€ 6,31
05926 2004	1/2 x (20x2)	10	1	€ 8,03

# F12 - RACCORDI MULTISTRATO A PRESSARE

## TES A PRESSARE

CODICE	DESCRIZIONE	CF	M.V.	PREZZO
05950 0016	16x2	10	1	€ 7,70
05950 0020	20x2	5	1	€ 9,50
05950 0026	26x3	5	1	€ 15,60



## TES FILETTATO FEMMINA A PRESSARE

CODICE	DESCRIZIONE	CF	M.V.	PREZZO
05951 1604	1/2 x (16x2)	10	1	€ 6,57
05951 2004	1/2 x (20x2)	5	1	€ 8,55
05951 2605	3/4 x (26x3)	5	1	€ 14,51



## TES FILETTATO MASCHIO A PRESSARE

CODICE	DESCRIZIONE	CF	M.V.	PREZZO
05952 1604	1/2 x (16x2)	10	1	€ 6,20
05952 2004	1/2 x (20x2)	5	1	€ 8,30
05952 2605	3/4 x (26 x3)	5	1	€ 13,50



## TES A PRESSARE RIDOTTO

CODICE	DESCRIZIONE	CF	M.V.	PREZZO
05958 2016	(20x2) x (16x2) x (20x2)	10	1	€ 11,44



## VALVOLA INCASSO A PRESSARE

CODICE	DESCRIZIONE	CF	M.V.	PREZZO
05960 1600	16	10	1	€ 28,16
05960 2000	20	10	1	€ 32,28



# VALVOLE E DETENTORI NERI PER TERMOARREDO



**NEW!**

## DESCRIZIONE

Valvole e detentori con finitura nero opaco per termoarredo corredati di bocchettone antigocciolamento.

## CARATTERISTICHE TECNICHE

**Fluidi di impiego:** acqua e soluzioni glicolate

**Percentuale max di glicole:** 50%

**Pressione max di esercizio:** 10 Bar

**Pressione max differenziale:** 1 Bar (con comando montato)

**Temperatura fluido termovettore:** 5 ÷ 120°C

**Connessione con testa termostatica:** 28 x 1,5

**Icma S.p.a.**

Via Garavaglia 4 Cuggiono (MI) - Italy

+39 02 97 24 9134

sales@icmaspa.it

**ICMA**



WWW.ICMASPA.IT

# F13 - RACCORDI MULTISTRATO A PRESSARE PER GAS

## MANICOTTO A PRESSARE GAS

CODICE	DESCRIZIONE	CF	M.V.	PREZZO
06002 1616	16 x 16	10	1	€ 5,57
06002 2020	20 x 20	10	1	€ 7,48



## RACCORDO MASCHIO A PRESSARE GAS

CODICE	DESCRIZIONE	CF	M.V.	PREZZO
06004 1604	16 x 1/2	10	1	€ 5,17
06004 2004	20 x 1/2	10	1	€ 5,66
06004 2005	20 x 3/4	10	1	€ 6,35



## RACCORDO FEMMINA A PRESSARE GAS

CODICE	DESCRIZIONE	CF	M.V.	PREZZO
06006 1604	16 x 1/2	10	1	€ 5,44
06006 2004	20 x 1/2	10	1	€ 6,05
06006 2005	20 x 3/4	10	1	€ 6,28



## TES A PRESSARE GAS

CODICE	DESCRIZIONE	CF	M.V.	PREZZO
06050 0016	16 x 16 x 16	10	1	€ 9,93
06050 0020	20 x 20 x 20	10	1	€ 12,95



# F13 - RACCORDI MULTISTRATO A PRESSARE PER GAS



## GOMITO A PRESSARE GAS

CODICE	DESCRIZIONE	CF	M.V.	PREZZO
06020 1616	16 x 16	10	1	€ 6,20
06020 2020	20 x 20	10	1	€ 9,59



## GOMITO MASCHIO A PRESSARE GAS

CODICE	DESCRIZIONE	CF	M.V.	PREZZO
06022 1604	16 x 1/2	10	1	€ 5,36
06022 2004	20 x 1/2	10	1	€ 7,18
06022 2005	20 x 3/4	10	1	€ 8,10



## GOMITO FEMMINA A PRESSARE GAS

CODICE	DESCRIZIONE	CF	M.V.	PREZZO
06023 1604	16 x 1/2	10	1	€ 5,04
06023 2004	20 x 1/2	10	1	€ 7,18
06023 2005	20 x 3/4	10	1	€ 8,41



## GOMITO FEMMINA C/STAFFA A PRESSARE GAS

CODICE	DESCRIZIONE	CF	M.V.	PREZZO
06026 1604	16 x 1/2	10	1	€ 9,10
06026 2004	20 x 1/2	10	1	€ 11,24

# F14 - RACCORDI MULTISTRATO A PRESSARE GIACOMINI

## RACCORDO DIRITTO A PRESSARE

CODICE	DESCRIZIONE	CF	M.V.	PREZZO
06202 1616	16x2	10	1	€ 7,41
06202 2020	20x2	10	1	€ 9,27
06202 2626	26x3	5	1	€ 13,61
06202 3232	32x3	5	1	€ 20,26



## RACCORDO DIRITTO RIDOTTO A PRESSARE

CODICE	DESCRIZIONE	CF	M.V.	PREZZO
06204 2016	(20x2) x (16x2)	10	1	€ 9,67
06204 2620	(26x3) x (20x2)	10	1	€ 12,82
06204 3226	(32x3) x (26x3)	5	1	€ 17,58



## RACCORDO DIRITTO FILETTATO MASCHIO

CODICE	DESCRIZIONE	CF	M.V.	PREZZO
06206 1604	1/2" x (16x2)	10	1	€ 5,03
06206 2004	1/2" x (20x2)	10	1	€ 5,86
06206 2005	3/4" x (20x2)	5	1	€ 6,95
06206 2605	3/4" x (26x3)	5	1	€ 8,76
06206 3206	1" x (32x3)	5	1	€ 13,58



## RACCORDO DIRITTO FILETTATO FEMMINA

CODICE	DESCRIZIONE	CF	M.V.	PREZZO
06208 1604	1/2" x (16x2)	10	1	€ 6,18
06208 2004	1/2" x (20x2)	10	1	€ 6,53
06208 2005	3/4" x (20x2)	5	1	€ 7,51
06208 2605	3/4" x (26x3)	5	1	€ 11,08
06208 3206	1" x (32x3)	5	1	€ 14,51



# F14 - RACCORDI MULTISTRATO A PRESSARE GIACOMINI



## RACCORDO CURVO 90° A PRESSARE

CODICE	DESCRIZIONE	CF	M.V.	PREZZO
06220 1616	16x2	10	1	€ 8,24
06220 2020	20x2	10	1	€ 10,65
06220 2626	26x3	5	1	€ 15,46
06220 3232	32x3	5	1	€ 23,10



## RACCORDO CURVO 90° FILETTATO MASCHIO

CODICE	DESCRIZIONE	CF	M.V.	PREZZO
06222 1604	1/2" x (16x2)	10	1	€ 6,88
06222 2004	1/2" x (20x2)	10	1	€ 8,11
06222 2005	3/4" x (20x2)	10	1	€ 8,88
06222 2605	3/4" x (26x3)	10	1	€ 10,67
06222 3206	1" x (32x3)	5	1	€ 17,23



## RACCORDO CURVO 90° FILETTATO FEMMINA

CODICE	DESCRIZIONE	CF	M.V.	PREZZO
06223 1604	1/2" x (16x2)	10	1	€ 6,82
06223 2004	1/2" x (20x2)	10	1	€ 8,06
06223 2005	3/4" x (20x2)	10	1	€ 9,06
06223 2605	3/4" x (26x3)	5	1	€ 11,51
06223 3206	1" x (32x3)	5	1	€ 17,58



## RACCORDO A GOMITO FILETTATO FEMMINA CON STAFFA

CODICE	DESCRIZIONE	CF	M.V.	PREZZO
06226 1604	1/2" x (16x2)	10	1	€ 8,90
06226 2004	1/2" x (20x2)	10	1	€ 9,95

# F14 - RACCORDI MULTISTRATO A PRESSARE GIACOMINI

## RACCORDO A T A PRESSARE

CODICE	DESCRIZIONE	CF	M.V.	PREZZO
06250 0016	16x2	10	1	€ 11,48
06250 0020	20x2	10	1	€ 14,19
06250 0026	26x3	5	1	€ 20,53
06250 0032	32x3	5	1	€ 30,87



## RACCORDO A T FILETTATO FEMMINA

CODICE	DESCRIZIONE	CF	M.V.	PREZZO
06251 1604	½" x (16x2)	10	1	€ 10,14
06251 2004	½" x (20x2)	10	1	€ 11,74
06251 2005	¾" x (26x3)	5	1	€ 17,40
06251 3206	1" x (32x3)	5	1	€ 28,03



## RACCORDO A T RIDOTTO A PRESSARE

CODICE	DESCRIZIONE	CF	M.V.	PREZZO
06258 2011	(20x2) x (16x2) x (16x2)	10	1	€ 14,37
06258 2012	(20x2) x (16x2) x (20x2)	10	1	€ 14,78
06258 2021	(20x2) x (20x2) x (16x2)	10	1	€ 14,78
06258 2622	(26x3) x (20x2) x (20x2)	10	1	€ 16,42
06258 2616	(26x3) x (16x2) x (26x3)	5	1	€ 18,88
06258 2626	(26x3) x (20x2) x (26x3)	5	1	€ 19,52
06258 3266	(32x3) x (26x3) x (26x3)	5	1	€ 33,98
06258 3263	(32x3) x (26x3) x (32x3)	5	1	€ 27,81



## RACCORDO DIRITTO FILETTATO FEMMINA C/GIRELLO

CODICE	DESCRIZIONE	CF	M.V.	PREZZO
06242 1604	16 x ½	10	1	€ 8,12
06242 2004	20 x ½	10	1	€ 8,78





## RACCORDO DIRITTO A PRESSARE - GAS

CODICE	DESCRIZIONE	CF	M.V.	PREZZO
06302 1616	16x2	10	1	€ 8,80
06302 2020	20x2	10	1	€ 11,47
06302 2626	26x3	5	1	€ 15,13



## RACCORDO DIRITTO FILETTATO MASCHIO A PRESSARE - GAS

CODICE	DESCRIZIONE	CF	M.V.	PREZZO
06306 1604	1/2" x (16x2)	10	1	€ 7,40
06306 2005	3/4" x (20x2)	5	1	€ 9,64
06306 2605	3/4" x (26x3)	5	1	€ 13,29



## RACCORDO DIRITTO FILETTATO FEMMINA A PRESSARE - GAS

CODICE	DESCRIZIONE	CF	M.V.	PREZZO
06308 1604	1/2" x (16x2)	10	1	€ 7,79
06308 2005	3/4" x (20x2)	5	1	€ 11,62
06308 2605	3/4" x (26x3)	5	1	€ 13,82

# F15 - RACCORDI MULTISTRATO A PRESSARE PER GAS GIACOMINI

## RACCORDO CURVO 90° A PRESSARE - GAS

CODICE	DESCRIZIONE	CF	M.V.	PREZZO
06320 1616	16x2	10	1	€ 11,49
06320 2020	20x2	10	1	€ 13,82
06320 2626	26x3	5	1	€ 20,37



## RACCORDO CURVO 90° FILETTATO MASCHIO A PRESSARE - GAS

CODICE	DESCRIZIONE	CF	M.V.	PREZZO
06322 1604	1/2" x (16x2)	10	1	€ 6,91
06322 2005	3/4" x (20x2)	10	1	€ 13,58
06322 2605	3/4" x (26x3)	10	1	€ 20,02



## RACCORDO CURVO 90° FILETTATO FEMMINA A PRESSARE - GAS

CODICE	DESCRIZIONE	CF	M.V.	PREZZO
06323 1604	1/2" x (16x2)	10	1	€ 7,95
06323 2005	3/4" x (20x2)	10	1	€ 13,25
06323 2605	3/4" x (26x3)	5	1	€ 13,87



## RACCORDO A GOMITO FILETTATO FEMMINA - GAS c/staffa

CODICE	DESCRIZIONE	CF	M.V.	PREZZO
06326 1604	1/2" x (16x2)	10	1	€ 11,59





## RACCORDO A T A PRESSARE MULTIPINZA - GAS

CODICE	DESCRIZIONE	CF	M.V.	PREZZO
06350 0016	16x2	10	1	€ 14,52
06350 0020	20x2	10	1	€ 18,07
06350 0026	26x3	5	1	€ 28,97



## RACCORDO A T FILETTATO FEMMINA A PRESSARE - GAS

CODICE	DESCRIZIONE	CF	M.V.	PREZZO
06351 1604	1/2" x (16x2)	10	1	€ 11,58
06351 2004	1/2" x (20x2)	5	1	€ 19,86
06351 2005	3/4" x (20x2)	10	1	€ 22,02
06351 2605	3/4" x (26x3)	5	1	€ 19,86



**AVANZATE TECNOLOGIE PLASTICHE**  
**ADVANCED PLASTIC TECHNOLOGIES**



**TORO 25**

**TUBI E RACCORDI IN PPR**



## TUBO IN PP-R PN20

CODICE	DESCRIZIONE	CL	CF	M.V.	PREZZO
06500 0020	Mis. 20 x 3,4	E	100	4	€ 2,46
06500 0025	Mis. 25 x 4,2	E	100	4	€ 3,88
06500 0032	Mis. 32 x 5,4	E	60	4	€ 6,35
06500 0040	Mis. 40 x 6,7	E	40	4	€ 10,10



## TUBO IN PP-R PN 10

CODICE	DESCRIZIONE	CF	M.V.	PREZZO
06501 0032	Mis. 32 x 2,9 PN 10	60	4	€ 4,25

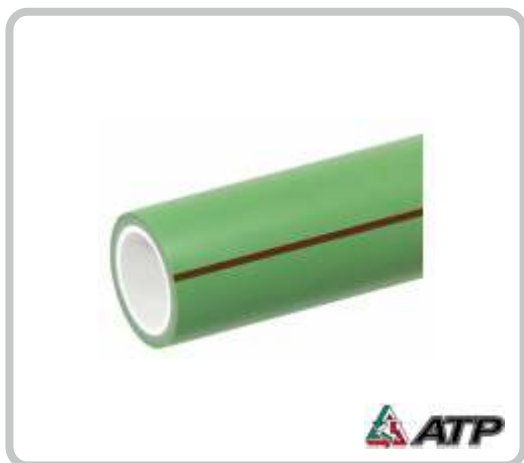

## TUBO IN PP-R FIBER EVO SDR11/S5 PER ACQUA REFRIGERATA

CODICE	DESCRIZIONE	CF	M.V.	PREZZO
06502 2500	Ø 25 x 3,5 PN20	100	4	€ 5,29
06502 3200	Ø 32 x 2,9 PN16	60	4	€ 6,75
06502 4000	Ø 40 x 3,7 PN16	40	4	€ 11,20
06502 5050	Ø 50 x 4,6 PN16	28	4	€ 15,50
06502 6300	Ø 63 x 5,8 PN16	20	4	€ 24,40
06502 7500	Ø 75 x 6,8 PN16	16	4	€ 33,26
06502 9000	Ø 90 x 8,2 PN16	12	4	€ 48,72



## TUBO ISOLANTE CELLULE CHIUSE SPESSORE 13 MM FIT2

CODICE	DESCRIZIONE	CF	M.V.	PREZZO
07403 0035	35 (interno 36-37,5), 1"	1	1	€ 4,69
07403 0042	42 (interno 45-47), 1-1/4	1	1	€ 5,43
07403 0048	48 (interno 51-53), 1-1/2	1	1	€ 6,20
07403 0054	54 (interno 55-58)	1	1	€ 7,30
07403 0064	64 (interno 63-65), 2"	1	1	€ 8,80
07403 0075	76 (interno 76-79), 2"1/2	1	1	€ 10,35
07403 0088	89 (interno 92-95), 3"	1	1	€ 12,63

- Prezzo riferito al tubo da 2 mt.

## TUBO DI SORPASSO IN PP-R per impianti sanitari, di riscaldamento e raffrescamento

CODICE	DESCRIZIONE	CL	CF	M.V.	PREZZO
06510 2020	Mis. 20	E	10	1	€ 2,95
06510 2525	Mis. 25	E	5	1	€ 4,18
06510 3232	Mis. 32	E	5	1	€ 6,60



## TUBO DI SORPASSO IN PP-R FF

CODICE	DESCRIZIONE	CF	M.V.	PREZZO
06512 2000	20	10	1	€ 4,00
06512 2500	25	5	1	€ 5,46



## MANICOTTO IN PP-R idoneo per impianti sanitari, di riscaldamento e raffrescamento

CODICE	DESCRIZIONE	CL	CF	M.V.	PREZZO
06504 0020	Mis. 20	E	10	10	€ 0,73
06504 0025	Mis. 25	E	5	5	€ 1,12
06504 0032	Mis. 32	E	5	5	€ 1,44
06504 0040	Mis. 40	E	1	1	€ 4,02
06504 0050	Mis. 50	E	1	1	€ 5,00
06504 0063	Mis. 63	E	1	1	€ 7,78
06504 0075	Mis. 75	E	1	1	€ 13,85
06504 0090	Mis. 90	E	1	1	€ 24,00

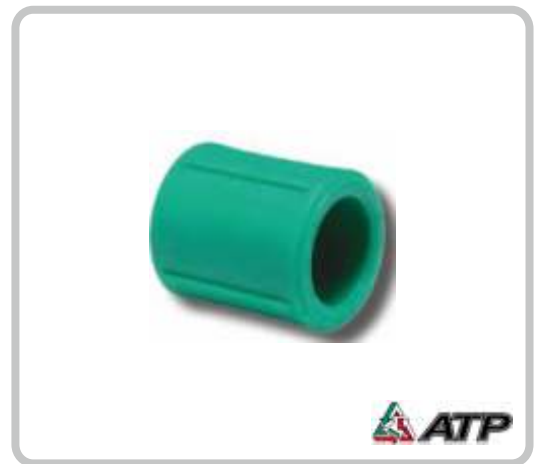

## RIDUZIONE MASCHIO-FEMMINA IN PP-R idoneo per impianti sanitari, di riscaldamento e raffrescamento

CODICE	DESCRIZIONE	CL	CF	M.V.	PREZZO
06542 2520	Mis. 25x20	E	10	10	€ 1,05
06542 3220	Mis. 32x20	E	5	5	€ 1,47
06542 3225	Mis. 32x25	E	5	5	€ 1,47
06542 4032	Mis. 40x32	E	5	5	€ 4,93
06542 5040	Mis. 50x40	E	5	5	€ 6,52
06542 6340	Mis. 63x40	E	5	5	€ 8,70





## MANICOTTO RIDOTTO IN PP-R FF

CODICE	DESCRIZIONE	CF	M.V.	PREZZO
06514 2500	25 x 20	10	10	€ 1,21
06514 3220	32 x 20	10	10	€ 2,00
06514 3225	32 x 25	10	10	€ 2,00



## RACCORDO DIRITTO IN PP-R CON TASCA A SALDARE FEMMINA E ATTACCO FILETTATO MASCHIO

CODICE	DESCRIZIONE	CL	CF	M.V.	PREZZO
06506 2004	Mis. 20x1/2"	E	10	1	€ 5,66
06506 2005	Mis. 20x3/4"	E	10	1	€ 10,75
06506 2504	Mis. 25x1/2"	E	10	1	€ 7,12
06506 2505	Mis. 25x3/4"	E	5	1	€ 8,40
06506 3206	Mis. 32/1"	E	2	1	€ 15,97
06506 4007	Mis. 40x1-1/4	E	1	1	€ 43,70
06506 5008	Mis. 50x1-1/2	E	1	1	€ 53,90
06506 6309	Mis. 63x2	E	1	1	€ 67,98



## RACCORDO DIRITTO CON TASCA A SALDARE FEMMINA E ATTACCO FILETTATO FEMMINA

CODICE	DESCRIZIONE	CL	CF	M.V.	PREZZO
06508 2004	Mis. 20x1/2"	E	10	1	€ 4,50
06508 2005	Mis. 20x3/4"	E	10	1	€ 5,15
06508 2504	Mis. 25x1/2"	E	10	1	€ 5,60
06508 2505	Mis. 25x3/4"	E	5	1	€ 5,85
06508 3206	Mis. 32x1"	E	2	1	€ 13,50
06508 4007	Mis. 40x1-1/4	E	1	1	€ 45,00
06508 5008	Mis. 50x1-1/2	E	1	1	€ 50,00
06508 6309	Mis. 63x2	E	1	1	€ 60,00
06508 7510	Mis. 75x2-1/2	E	1	1	€ 105,00
06508 9011	Mis. 90x3	E	1	1	€ 198,00



## RACCORDO CURVO 90° IN PP-R

idoneo per impianti sanitari, di riscaldamento e raffrescamento

CODICE	DESCRIZIONE	CL	CF	M.V.	PREZZO
06520 2020	Mis. 20	E	10	10	€ 0,69
06520 2525	Mis. 25	E	5	5	€ 1,10
06520 3232	Mis. 32	E	5	5	€ 1,98
06520 4040	Mis. 40	E	1	1	€ 4,00
06520 5050	Mis. 50	E	1	1	€ 6,54
06520 6363	Mis. 63	E	1	1	€ 11,34
06520 7575	Mis. 75	E	1	1	€ 18,38
06520 9090	Mis. 90	E	1	1	€ 30,50

## RACCORDO CURVO 90° IN PP-R MF

idoneo per impianti sanitari, di riscaldamento e raffrescamento

CODICE	DESCRIZIONE	CL	CF	M.V.	PREZZO
06521 2020	Mis. 20	E	10	1	€ 2,10
06521 2525	Mis. 25	E	5	1	€ 2,82
06521 3232	Mis. 32	E	5	1	€ 3,90



## RACCORDO CURVO 45° IN PP-R

CODICE	DESCRIZIONE	CL	CF	M.V.	PREZZO
06524 2020	Mis. 20	E	10	1	€ 1,18
06524 2525	Mis. 25	E	5	1	€ 1,70
06524 3232	Mis. 32	E	5	1	€ 2,73
06524 4040	Mis. 40	E	5	1	€ 5,95



## RACCORDO CURVO 90° IN PP-R con tasca a saldare femmina e attacco filettato maschio

CODICE	DESCRIZIONE	CL	CF	M.V.	PREZZO
06522 2004	Mis. 20x1/2"	E	10	1	€ 6,10
06522 2504	Mis. 25x1/2"	E	5	1	€ 7,20
06522 2505	Mis. 25x3/4"	E	5	1	€ 10,69
06522 3206	Mis. 32x1"	E	2	1	€ 19,00



## RACCORDO CURVO 90° IN PP-R con tasca a saldare femmina e attacco filettato femmina

CODICE	DESCRIZIONE	CL	CF	M.V.	PREZZO
06523 2004	Mis. 20x1/2"	E	10	1	€ 4,73
06523 2504	Mis. 25x1/2"	E	10	1	€ 6,40
06523 2505	Mis. 25x3/4"	E	5	1	€ 8,40
06523 3206	Mis. 32x1"	E	2	1	€ 16,20



## RACCORDO CURVO 90° IN PP-R con staffa di fissaggio a parete, Tasca a saldare femmina e attacco filettato femmina

CODICE	DESCRIZIONE	CL	CF	M.V.	PREZZO
06526 2004	Mis. 20x1/2"	E	10	1	€ 5,86





## RACCORDO A T IN PP-R

CODICE	DESCRIZIONE	CL	CF	M.V.	PREZZO
06550 0020	Mis. 20	E	10	1	€ 0,94
06550 0025	Mis. 25	E	5	1	€ 1,26
06550 0032	Mis. 32	E	5	1	€ 2,14
06550 0040	Mis. 40	E	1	1	€ 5,06
06550 0050	Mis. 50	E	1	1	€ 7,40
06550 0063	Mis. 63	E	1	1	€ 11,66
06550 0075	Mis. 75	E	1	1	€ 21,00
06550 0090	Mis. 90	E	1	1	€ 33,90



## RACCORDO A T IN PP-R ridotto

CODICE	DESCRIZIONE	CL	CF	M.V.	PREZZO
06558 2520	Mis. 25x20x25	E	10	1	€ 1,68
06558 3220	Mis. 32x20x32	E	5	1	€ 2,80
06558 3225	Mis. 32x25x32	E	5	1	€ 2,80



## RACCORDO A T filettato femmina in PP-R con tasche a saldare femmina e attacco filettato femmina

CODICE	DESCRIZIONE	CL	CF	M.V.	PREZZO
06551 2004	Mis. 20x1/2"x20	E	10	1	€ 5,88
06551 2505	Mis. 25x3/4"x25	E	5	1	€ 9,94
06551 3206	Mis. 32x1"x32	E	2	1	€ 19,06



## TAPPO TERMINALE IN PP-R H165 con tasca a saldare femmina

CODICE	DESCRIZIONE	CL	CF	M.V.	PREZZO
06560 0020	Mis. 20	Z	10	1	€ 1,11
06560 0025	Mis. 25	Z	5	1	€ 1,33
06560 0032	Mis. 32	Z	5	1	€ 1,95
06560 0040	Mis. 40	Z	5	1	€ 6,52
06560 0050	Mis. 50	Z	1	1	€ 8,00
06560 0063	Mis. 63	Z	1	1	€ 10,90
06560 0075	Mis. 75	Z	1	1	€ 13,70
06560 0090	Mis. 90	Z	1	1	€ 24,00

## RUBINETTO D'ARRESTO A VITONE IN PP-R con farfalla di manovra e cappuccio cromato

CODICE	DESCRIZIONE	CL	CF	M.V.	PREZZO
06570 0020	Mis. 20	E	1	1	€ 28,60
06570 0025	Mis. 25	E	1	1	€ 31,97
06570 0032	Mis. 32	E	1	1	€ 39,70



## VALVOLA A SFERA METALLO PN 25 CON LEVA

CODICE	DESCRIZIONE	CF	M.V.	PREZZO
06573 0025	∅ 25	10	1	€ 49,50
06573 0032	∅ 32	10	1	€ 60,00

- PN 25



## VALVOLA A SFERA IN PPR CON LEVA

CODICE	DESCRIZIONE	CF	M.V.	PREZZO
06572 0020	∅ 20	1	1	€ 12,75
06572 0025	∅ 25	1	1	€ 16,50
06572 0032	∅ 32	1	1	€ 22,10
06572 0040	∅ 40	1	1	€ 36,50



## TAPPO DI CHIUSURA PER COLLAUDO IMPIANTI press. max 10bar

CODICE	DESCRIZIONE	CL	CF	M.V.	PREZZO
05000 0100	Mis. 1/2" M-rosso	E	100	10	€ 0,47
05000 0200	Mis. 1/2" M-blu	E	100	10	€ 0,47



**New**



RIEADRO

## TUBO IN PP-R NERO

CODICE	DESCRIZIONE	CF	M.V.	PREZZO
06584 0020	∅ 20 x 2,8	120	4	€ 5,47
06584 0025	∅ 25 x 3,5	80	4	€ 8,28
06584 0032	∅ 32 x 4,4	48	4	€ 13,46

- SDR 7,4

**New**



RIEADRO

## MANICOTTO IN PP-R NERO

CODICE	DESCRIZIONE	CF	M.V.	PREZZO
06585 0020	∅ 20	10	10	€ 1,61
06585 0025	∅ 25	10	10	€ 1,92
06585 0032	∅ 32	5	5	€ 2,72

**New**



RIEADRO

## GOMITO IN PP-R NERO

CODICE	DESCRIZIONE	CF	M.V.	PREZZO
06586 0020	∅ 20	10	10	€ 1,72
06586 0025	∅ 25	10	10	€ 2,30
06586 0032	∅ 32	5	5	€ 3,46

**New**



RIEADRO

## TES IN PP-R NERO

CODICE	DESCRIZIONE	CF	M.V.	PREZZO
06588 0020	∅ 20	10	10	€ 1,95
06588 0025	∅ 25	10	10	€ 2,38
06588 0032	∅ 32	5	5	€ 4,90

## CASSETTA CON POLIFUSIONE MEDIO

CODICE	DESCRIZIONE	CF	M.V.	PREZZO
06580 0000	Completa di supporto e metrici 20-25-32	1	1	€ 192,50



## MATRICI PER POLIFUSORE

CODICE	DESCRIZIONE	CF	M.V.	PREZZO
06582 0020	∅ 20	1	1	€ 12,70
06582 0025	∅ 25	1	1	€ 17,50
06582 0032	∅ 32	1	1	€ 24,08
06582 0040	∅ 40	1	1	€ 58,00
06582 0050	∅ 50	1	1	€ 73,50
06582 0063	∅ 63	1	1	€ 84,00
06582 0075	∅ 75	1	1	€ 126,00
06582 0090	∅ 90	1	1	€ 152,00

**New**



## MATRICE RIPARAFORI

CODICE	DESCRIZIONE	CF	M.V.	PREZZO
06583 0007	7 mm	1	1	€ 61,30

**New**



## RIPARAFORI IN PPR

CODICE	DESCRIZIONE	CF	M.V.	PREZZO
06589 0000	7/11 mm	50	1	€ 1,18

**New**





## TUBO IN POLIETILENE A BASSA DENSITÀ PN 6

CODICE	DESCRIZIONE	CF	M.V.	PREZZO
06906 0020	Ø 20	300	300	€ 1,32
06906 0025	Ø 25	200	200	€ 1,96
06906 0032	Ø 32	200	200	€ 3,21
06906 0040	Ø 40	100	100	€ 4,89
06906 0050	Ø 50	100	100	€ 7,53



**New**

## TUBO IN POLIETILENE A BASSA DENSITÀ PN 10

CODICE	DESCRIZIONE	CF	M.V.	PREZZO
06908 0032	Ø 32	200	200	€ 3,74



**New**

## ALA GOCCIOLANTE DM 16

CODICE	DESCRIZIONE	CF	M.V.	PREZZO
06904 0020	passo 20 - lt/h 4	50	50	€ 0,59



**New**

## MANICHETTA DM 16 (TAPE)

CODICE	DESCRIZIONE	CF	M.V.	PREZZO
06902 0020	passo 20 - lt/h 2,2	100	100	€ 0,26



## TUBO IN POLIETILENE ALTA DENSITÀ PN 10

CODICE	DESCRIZIONE	CF	M.V.	PREZZO
06910 0020	Ø 20	100	100	€ 1,38
06910 0025	Ø 25	100	100	€ 2,26
06910 0032	Ø 32	100	100	€ 3,22
06910 0040	Ø 40	100	100	€ 4,84
06910 0050	Ø 50	100	100	€ 7,50



## TUBO IN POLIETILENE ALTA DENSITÀ PN 16

CODICE	DESCRIZIONE	CF	M.V.	PREZZO
06916 0020	Ø 20	100	100	€ 1,83
06916 0025	Ø 25	100	100	€ 2,77
06916 0032	Ø 32	100	100	€ 4,36
06916 0040	Ø 40	100	100	€ 6,80
06916 0050	Ø 50	100	100	€ 10,29



## TUBO IN POLIETILENE ALTA DENSITÀ PN 25

CODICE	DESCRIZIONE	CF	M.V.	PREZZO
06925 0020	Ø 20	100	100	€ 2,70
06925 0025	Ø 25	100	100	€ 3,92
06925 0032	Ø 32	100	100	€ 6,20





## RACCORDO BIGIUNTO PER TUBO PE

CODICE	DESCRIZIONE	CF	M.V.	PREZZO
06602 2020	20 x 20 - anelli in teflon	10	1	€ 6,56
06602 2525	25 x 25 - anelli in teflon	10	1	€ 11,20
06602 3232	32 x 32 - anelli in teflon	10	1	€ 16,33
06602 4040	40 x 40 - anelli in teflon	5	1	€ 23,75
06602 5050	50 x 50 - anelli in teflon	1	1	€ 32,66
06602 6363	63 x 63 - anelli in teflon	1	1	€ 53,71



## RACCORDO MASCHIO PER TUBO PE

CODICE	DESCRIZIONE	CF	M.V.	PREZZO
06606 2004	20 x 1/2 - anello in teflon	10	1	€ 4,03
06606 2505	25 x 3/4 - anello in teflon	10	1	€ 7,07
06606 3206	32 x 1" - anello in teflon	10	1	€ 9,78
06606 4007	40 x 1-1/4 - anello in teflon	5	1	€ 15,18
06606 5008	50 x 1-1/2 - anello in teflon	1	1	€ 21,51
06606 6309	63 x 2" - anello in teflon	1	1	€ 33,24



## RACCORDO FEMMINA PER TUBO PE

CODICE	DESCRIZIONE	CF	M.V.	PREZZO
06608 2004	20 x 1/2 - anello in teflon	10	1	€ 3,97
06608 2505	25 x 3/4 - anello in teflon	10	1	€ 7,22
06608 3206	32 x 1" - anello in teflon	10	1	€ 9,50
06608 4007	40 x 1-1/4 - anello in teflon	5	1	€ 17,02
06608 5008	50 x 1-1/2 - anello in teflon	1	1	€ 23,29
06608 6309	63 x 2" - anello in teflon	1	1	€ 33,70



## GOMITO DOPPIO PER TUBO PE

CODICE	DESCRIZIONE	CF	M.V.	PREZZO
06620 2020	20 x 20 - anelli in teflon	10	1	€ 7,68
06620 2525	25 x 25 - anelli in teflon	10	1	€ 13,30
06620 3232	32 x 32 - anelli in teflon	10	1	€ 21,00
06620 4040	40 x 40 - anelli in teflon	5	1	€ 31,74
06620 5050	50 x 50 - anelli in teflon	1	1	€ 42,95
06620 6363	63 x 63 - anelli in teflon	1	1	€ 72,45

# F18 - RACCORDI OTTONE PER TUBO POLIETILENE ANIMA IN TEFLON

## GOMITO MASCHIO PER TUBI IN PE

CODICE	DESCRIZIONE	CF	M.V.	PREZZO
06622 2004	20 x 1/2 - anelli in teflon	10	1	€ 5,52
06622 2505	25 x 3/4 - anelli in teflon	10	1	€ 9,49
06622 3206	32 x 1" - anelli in teflon	10	1	€ 12,82
06622 4007	40 x 1-1/4 - anelli in teflon	5	1	€ 23,00
06622 5008	50 x 1-1/2 - anelli in teflon	1	1	€ 34,45
06622 6309	63 x 2" - anelli in teflon	1	1	€ 64,75



## GOMITO FEMMINA PER TUBI IN PE

CODICE	DESCRIZIONE	CF	M.V.	PREZZO
06623 2004	20 x 1/2 - anelli in teflon	10	1	€ 5,49
06623 2505	25 x 3/4 - anelli in teflon	10	1	€ 8,30
06623 3206	32 x 1" - anelli in teflon	10	1	€ 11,75
06623 4007	40 x 1-1/4 - anelli in teflon	5	1	€ 23,12
06623 5008	50 x 1-1/2 - anelli in teflon	1	1	€ 32,87
06623 6309	63 x 2" - anelli in teflon	1	1	€ 71,22



## GOMITO FEMMINA FLANGIATO PER TUBI IN PE

CODICE	DESCRIZIONE	CF	M.V.	PREZZO
06626 2004	20 x 1/2 - anelli in teflon	1	1	€ 7,25
06626 2505	25 x 3/4 - anelli in teflon	1	1	€ 10,58
06626 3206	32 x 1" - anelli in teflon	1	1	€ 15,87



## TES PER TUBI IN PE

CODICE	DESCRIZIONE	CF	M.V.	PREZZO
06650 0020	20 x 20 x 20 - anelli in teflon	5	1	€ 10,93
06650 0025	25 x 25 x 25 - anelli in teflon	5	1	€ 21,28
06650 0032	32 x 32 x 32 - anelli in teflon	5	1	€ 23,75
06650 0040	40 x 40 x 40 - anelli in teflon	1	1	€ 41,98
06650 0050	50 x 50 x 50 - anelli in teflon	1	1	€ 61,53
06650 0063	63 x 63 x 63 - anelli in teflon	1	1	€ 95,80



## TES CON DERIVAZIONE FEMMINA PER TUBO IN PE

CODICE	DESCRIZIONE	CF	M.V.	PREZZO
06651 2004	20 x 1/2 x 20 - anelli in teflon	5	1	€ 7,94
06651 2505	25 x 3/4 x 25 - anelli in teflon	5	1	€ 14,84
06651 3206	32 x 1" x 32 - anelli in teflon	5	1	€ 20,70
06651 4007	40 x 1-1/4 x 40 - anelli in teflon	1	1	€ 33,35
06651 5008	50 x 1-1/2 x 50 - anelli in teflon	1	1	€ 50,60
06651 6309	63 x 2" x 63 - anelli in teflon	1	1	€ 86,25



# F19 - RACCORDI PER TUBO PE CON ANIMA IN OTTONE



## RACCORDO BIGIUNTO CON ANIMA IN OTTONE

CODICE	DESCRIZIONE	CF	M.V.	PREZZO
06702 2020	20 x 20	10	1	€ 6,56
06702 2525	25 x 25	10	1	€ 11,20
06702 3232	32 x 32	10	1	€ 16,33
06702 4040	40 x 40	5	1	€ 23,75
06702 5050	50 x 50	1	1	€ 32,66
06702 6363	63 x 63	1	1	€ 53,71



## RACCORDO MASCHIO CON ANIMA IN OTTONE

CODICE	DESCRIZIONE	CF	M.V.	PREZZO
06706 2004	20 x 1/2"	10	1	€ 4,03
06706 2505	25 x 3/4"	10	1	€ 7,07
06706 3206	32 x 1"	10	1	€ 9,78
06706 4007	40 x 1" 1/4	5	1	€ 15,18
06706 5008	50 x 1" 1/2	1	1	€ 21,51
06706 6309	63 x 2"	1	1	€ 33,24



## RACCORDO FEMMINA CON ANIMA IN OTTONE

CODICE	DESCRIZIONE	CF	M.V.	PREZZO
06708 2004	20 x 1/2"	10	1	€ 3,97
06708 2505	25 x 3/4"	10	1	€ 7,22
06708 3206	32 x 1"	10	1	€ 9,50
06708 4007	40 x 1" 1/4	5	1	€ 17,02
06708 5008	50 x 1" 1/2	1	1	€ 23,29
06708 6309	63 x 2"	1	1	€ 33,70



## GOMITO CON ANIMA IN OTTONE

CODICE	DESCRIZIONE	CF	M.V.	PREZZO
06720 2020	20 x 20	10	1	€ 7,68
06720 2525	25 x 25	10	1	€ 13,30
06720 3232	32 x 32	10	1	€ 21,00
06720 4040	40 x 40	5	1	€ 31,74
06720 5050	50 x 50	1	1	€ 42,95
06720 6363	63 x 63	1	1	€ 72,45

# F19 - RACCORDI PER TUBO PE CON ANIMA IN OTTONE

## GOMITO MASCHIO CON ANIMA IN OTTONE

CODICE	DESCRIZIONE	CF	M.V.	PREZZO
06722 2004	20 x 1/2"	10	1	€ 5,52
06722 2505	25 x 3/4"	10	1	€ 9,49
06722 3206	32 x 1"	10	1	€ 12,82
06722 4007	40 x 1" 1/4	5	1	€ 23,00
06722 5008	50 x 1" 1/2	1	1	€ 34,45
06722 6309	63 x 2"	1	1	€ 64,75



## GOMITO FEMMINA CON ANIMA IN OTTONE

CODICE	DESCRIZIONE	CF	M.V.	PREZZO
06723 2004	20 x 1/2"	10	1	€ 5,49
06723 2505	25 x 3/4"	10	1	€ 8,30
06723 3206	32 x 1"	10	1	€ 11,75
06723 4007	40 x 1" 1/4	5	1	€ 23,12
06723 5008	50 x 1" 1/2	1	1	€ 32,87
06723 6309	63 x 2"	1	1	€ 71,22



## GOMITO FEMMINA C/FLANGIA CON ANIMA IN OTTONE

CODICE	DESCRIZIONE	CF	M.V.	PREZZO
06726 2004	20 x 1/2"	10	1	€ 7,25
06726 2505	25 x 3/4"	10	1	€ 10,58
06726 3206	32 x 1"	10	1	€ 15,87



## TEE CON ANIMA IN OTTONE

CODICE	DESCRIZIONE	CF	M.V.	PREZZO
06750 0020	20 x 20 x 20	10	1	€ 10,93
06750 0025	25 x 25 x 25	10	1	€ 21,28
06750 0032	32 x 32 x 32	10	1	€ 23,75
06750 0040	40 x 40 x 40	5	1	€ 41,98
06750 0050	50 x 50 x 50	1	1	€ 61,53
06750 0063	63 x 63 x 63	1	1	€ 95,80



# F19 - RACCORDI PER TUBO PE CON ANIMA IN OTTONE



## TEE FEMMINA CON ANIMA IN OTTONE

CODICE	DESCRIZIONE	CF	M.V.	PREZZO
06751 2004	20 x 1/2" x 20	1	10	€ 7,97
06751 2505	25 x 3/4 x 25	1	10	€ 14,84
06751 3206	32 x 1" x 32	1	10	€ 20,70
06751 4007	40 x 1" 1/4 x 40	1	5	€ 33,35
06751 5008	50 x 1" 1/2 x 50	1	1	€ 50,60
06751 6309	63 x 2" x 63	1	1	€ 86,25



## BOCCOLA DI RINFORZO IN OTTONE

CODICE	DESCRIZIONE	CF	M.V.	PREZZO
06760 0020	20	10	10	€ 2,72
06760 0025	25	10	10	€ 5,22
06760 0032	32	10	10	€ 5,66
06760 0040	40	5	5	€ 6,24
06760 0050	50	1	1	€ 7,16
06760 0063	63	1	1	€ 10,62



## ANELLO DI ANCORAGGIO IN OTTONE

CODICE	DESCRIZIONE	CF	M.V.	PREZZO
06762 0020	20	10	10	€ 2,22
06762 0025	25	10	10	€ 3,02
06762 0032	32	10	10	€ 3,49
06762 0040	40	5	5	€ 5,94
06762 0050	50	1	1	€ 6,67
06762 0063	63	1	1	€ 9,46



## GUARNIZIONE IN GOMMA

CODICE	DESCRIZIONE	CF	M.V.	PREZZO
06764 0020	20	10	10	€ 1,82
06764 0025	25	10	10	€ 2,72
06764 0032	32	10	10	€ 3,63
06764 0040	40	5	5	€ 4,53
06764 0050	50	1	1	€ 4,99
06764 0063	63	1	1	€ 5,45

## MANICOTTO

CODICE	DESCRIZIONE	CF	M.V.	PREZZO
06802 1616	16	20	1	€ 1,73
06802 2020	20	20	1	€ 2,85
06802 2525	25	10	1	€ 3,39
06802 3232	32	10	1	€ 4,30
06802 4040	40	5	1	€ 7,50
06802 5050	50	5	1	€ 9,22
06802 6363	63	1	1	€ 14,08
06802 7575	75	1	1	€ 27,31
06802 9090	90	1	1	€ 38,50
06802 1111	110	1	1	€ 67,75



## MANICOTTO RIDOTTO

CODICE	DESCRIZIONE	CF	M.V.	PREZZO
06804 2016	20-16	20	1	€ 2,48
06804 2525	25-20	20	1	€ 2,91
06804 3225	32-25	10	1	€ 4,40
06804 4032	40-32	10	1	€ 7,50
06804 5040	50-40	5	1	€ 9,13
06804 6350	63-50	1	1	€ 12,50
06804 7563	75-63	1	1	€ 25,81
06804 9063	90-63	1	1	€ 38,25
06804 9075	90-75	1	1	€ 38,25
06804 1190	110-90	1	1	€ 80,16



## RACCORDO MASCHIO

CODICE	DESCRIZIONE	CF	M.V.	PREZZO
06806 1604	16x1/2"	20	1	€ 1,31
06806 1605	16x3/4"	20	1	€ 1,31
06806 2004	20x1/2"	20	1	€ 1,66
06806 2005	20x3/4"	20	1	€ 1,55
06806 2006	20x1"	20	1	€ 1,65
06806 2504	25x1/2"	20	1	€ 1,88
06806 2505	25x3/4"	20	1	€ 2,02
06806 2506	25x1"	20	1	€ 2,16
06806 3205	32x3/4"	10	1	€ 2,13
06806 3206	32x1"	10	1	€ 2,23
06806 3207	32x1"1/4	10	1	€ 3,00
06806 4006	40x1"	10	1	€ 4,35
06806 4007	40x1"1/4	5	1	€ 4,35
06806 4008	40x1"1/2	5	1	€ 4,35
06806 5008	50x1"1/2	5	1	€ 6,26
06806 5009	50x2"	5	1	€ 6,26
06806 6308	63x1"1/2	1	1	€ 8,25
06806 6309	63x2"	1	1	€ 8,25
06806 7509	75x2"	1	1	€ 17,66
06806 7510	75x2"1/2	1	1	€ 17,66
06806 9011	90x3"	1	1	€ 21,82
06806 1112	110x4"	1	1	€ 44,19



# F20 - RACCORDI POLIETILENE AD PN16



## RACCORDO FEMMINA

CODICE	DESCRIZIONE	CF	M.V.	PREZZO
06808 1604	16x1/2"	20	1	€ 1,21
06808 1605	16x3/4"	20	1	€ 1,49
06808 2004	20x1/2"	20	1	€ 1,95
06808 2005	20x3/4"	20	1	€ 1,61
06808 2504	25x1/2"	20	1	€ 2,38
06808 2505	25x3/4"	20	1	€ 2,05
06808 2506	25x1"	20	1	€ 1,80
06808 3205	32x3/4"	10	1	€ 2,34
06808 3206	32x1"	10	1	€ 2,60
06808 4006	40x1"	10	1	€ 5,27
06808 4007	40x1"1/4	10	1	€ 4,33
06808 5008	50x1"1/2	5	1	€ 5,87
06808 5009	50x2"	5	1	€ 5,96
06808 6309	63x2"	1	1	€ 7,94
06808 7510	75x2"1/2	1	1	€ 22,97
06808 9011	90x3"	1	1	€ 32,08
06808 1112	110x4"	1	1	€ 61,36



## GOMITO A 90°

CODICE	DESCRIZIONE	CF	M.V.	PREZZO
06820 1616	16	20	1	€ 2,30
06820 2020	20	20	1	€ 2,81
06820 2525	25	20	1	€ 3,64
06820 3232	32	10	1	€ 4,00
06820 4040	40	5	1	€ 7,84
06820 5050	50	4	1	€ 11,77
06820 6363	63	1	1	€ 13,00
06820 7575	75	1	1	€ 27,26
06820 9090	90	1	1	€ 41,24
06820 1111	110	1	1	€ 51,15



## GOMITO A 90° FILETTATO MASCHIO

CODICE	DESCRIZIONE	CF	M.V.	PREZZO
06822 1604	16x1/2"	20	1	€ 2,09
06822 2004	20x1/2"	20	1	€ 1,77
06822 2005	20x3/4"	20	1	€ 1,72
06822 2504	25x1/2"	20	1	€ 2,13
06822 2505	25x3/4"	20	1	€ 2,21
06822 2506	25x1"	20	1	€ 2,11
06822 3205	32x3/4"	10	1	€ 2,76
06822 3206	32x1"	10	1	€ 2,96
06822 3207	32x1"1/4	10	1	€ 3,00
06822 4006	40x1"	5	1	€ 5,50
06822 4007	40x1"1/4	10	1	€ 6,13
06822 5008	50x1"1/2	5	1	€ 7,40
06822 6309	63x2"	1	1	€ 12,05
06822 7510	75x2"1/2	1	1	€ 26,30
06822 9011	90x3"	1	1	€ 34,79
06822 1112	110x4"	1	1	€ 67,84

## GOMITO A 90° FILETTO FEMMINA

CODICE	DESCRIZIONE	CF	M.V.	PREZZO
06823 1604	16x1/2"	20	1	€ 1,62
06823 2004	20x1/2"	20	1	€ 1,95
06823 2005	20x3/4"	20	1	€ 1,88
06823 2504	25x1/2"	20	1	€ 2,46
06823 2505	25x3/4"	20	1	€ 2,53
06823 3205	32x3/4"	10	1	€ 3,76
06823 3206	32x1"	5	1	€ 3,00
06823 4007	40x1"1/4	1	1	€ 6,00
06823 5008	50x1"1/2	1	1	€ 8,33
06823 5009	50x2"	1	1	€ 8,35
06823 6309	63x2"	1	1	€ 11,69
06823 7510	75x2"1/2	1	1	€ 29,78
06823 9011	90x3"	1	1	€ 39,66
06823 1112	110x4"	1	1	€ 76,60



## GOMITO A 90° FILETTO FEMMINA C/STAFFA

CODICE	DESCRIZIONE	CF	M.V.	PREZZO
06824 2004	20 x 1/2	10	1	€ 4,75
06824 2505	25 x 3/4	10	1	€ 4,75



## TEE A 90°

CODICE	DESCRIZIONE	CF	M.V.	PREZZO
06850 0016	16	20	1	€ 2,89
06850 0020	20	20	1	€ 3,73
06850 0025	25	10	1	€ 5,20
06850 0032	32	5	1	€ 6,15
06850 0040	40	5	1	€ 11,50
06850 0050	50	1	1	€ 16,37
06850 0063	63	1	1	€ 17,70
06850 0075	75	1	1	€ 42,11
06850 0090	90	1	1	€ 55,18
06850 0110	110	1	1	€ 68,24



## TEE A 90° FILETTATO MASCHIO

CODICE	DESCRIZIONE	CF	M.V.	PREZZO
06852 1604	16x1/2"	20	1	€ 2,99
06852 2004	20x1/2"	20	1	€ 3,32
06852 2005	20x3/4"	20	1	€ 2,99
06852 2505	25x3/4"	10	1	€ 4,68
06852 2506	25x1"	10	1	€ 4,68
06852 3205	32x3/4"	10	1	€ 5,36
06852 3206	32x1"	10	1	€ 5,36
06852 4006	40x1"	5	1	€ 8,79
06852 4007	40x1"1/4	5	1	€ 9,75
06852 5008	50x1"1/2	1	1	€ 17,50
06852 6309	63x2"	1	1	€ 31,74
06852 7510	75x2"1/2	1	1	€ 44,73
06852 9011	90x3"	1	1	€ 61,93
06852 1112	110x4"	1	1	€ 119,00



# F21 - RACCORDI POLIETILENE FILETTATI



## TEE A 90° FILETTATA FEMMINA

CODICE	DESCRIZIONE	CF	M.V.	PREZZO
06851 1604	16x1/2"	20	1	€ 3,19
06851 1605	16x3/4"	20	1	€ 3,19
06851 2004	20x1/2"	20	1	€ 3,19
06851 2005	20x3/4"	20	1	€ 3,34
06851 2504	25x1/2"	10	1	€ 4,21
06851 2505	25x3/4"	10	1	€ 4,29
06851 2506	25x1"	10	1	€ 4,29
06851 3205	32x3/4"	10	1	€ 4,80
06851 3206	32x1"	10	1	€ 4,75
06851 4006	40x1"	5	1	€ 9,72
06851 4007	40x1"1/4	5	1	€ 9,78
06851 4008	40x1"1/2	5	1	€ 9,81
06851 5008	50x1"1/2	1	1	€ 20,04
06851 5009	50x2"	1	1	€ 20,04
06851 6309	63x2"	1	1	€ 21,49
06851 7510	75x2"1/2	1	1	€ 48,50
06851 9011	90x3"	1	1	€ 80,89
06851 1111	110x3"	1	1	€ 124,37
06851 1112	110x4"	1	1	€ 124,37



## MANICOTTO

CODICE	DESCRIZIONE	CF	M.V.	PREZZO
06810 0400	1/2"	20	1	€ 1,06
06810 0500	3/4"	20	1	€ 0,69
06810 0600	1"	20	1	€ 1,11
06810 0700	1"1/4	10	1	€ 2,28
06810 0800	1"1/2	10	1	€ 2,94
06810 0900	2"	5	1	€ 3,91
06810 1000	2"1/2	1	1	€ 12,55
06810 1100	3"	1	1	€ 14,37
06810 1200	4"	1	1	€ 29,84



## RIDUZIONE CORTA M/F

CODICE	DESCRIZIONE	CF	M.V.	PREZZO
06842 0504	3/4"x1/2"	50	1	€ 0,78
06842 0604	1"x1/2"	50	1	€ 0,78
06842 0605	1"x3/4"	50	1	€ 0,78
06842 0704	1"1/4x1/2"	10	1	€ 1,33
06842 0705	1"1/4x3/4"	10	1	€ 1,33
06842 0706	1"1/4x1"	10	1	€ 1,25
06842 0804	1"1/2x1/2"	10	1	€ 1,67
06842 0805	1"1/2x3/4"	10	1	€ 1,67
06842 0806	1"1/2x1"	10	1	€ 2,26
06842 0807	1"1/2x1"1/4	10	1	€ 1,60
06842 0905	2"x3/4"	5	1	€ 4,17
06842 0906	2"x1"	5	1	€ 4,35
06842 0907	2"x1"1/4	5	1	€ 3,26
06842 0908	2"x1"1/2	5	1	€ 3,64
06842 1007	2"1/2x1"1/4	1	1	€ 6,18
06842 1008	2"1/2x1"1/2	1	1	€ 6,18
06842 1009	2"1/2x2"	1	1	€ 6,14
06842 1106	3"x1"	1	1	€ 8,51
06842 1107	3"x1"1/4	1	1	€ 8,69
06842 1108	3"x1"1/2	1	1	€ 8,69
06842 1109	3"x2"	1	1	€ 8,47
06842 1110	3"x2"1/2	1	1	€ 9,23
06842 1209	4"x2"	1	1	€ 15,19
06842 1211	4"x3"	1	1	€ 15,19

## NIPPLO

CODICE	DESCRIZIONE	CF	M.V.	PREZZO
06830 0404	1/2"	20	1	€ 0,42
06830 0505	3/4"	20	1	€ 0,42
06830 0606	1"	20	1	€ 0,42
06830 0707	1"1/4	10	1	€ 0,88
06830 0808	1"1/2	10	1	€ 1,24
06830 0909	2"	10	1	€ 1,74
06830 1010	2"1/2	1	1	€ 4,07
06830 1111	3"	1	1	€ 4,58
06830 1212	4"	1	1	€ 11,76



## NIPPLO RIDOTTO

CODICE	DESCRIZIONE	CF	M.V.	PREZZO
06832 0504	3/4"x1/2"	20	1	€ 0,38
06832 0604	1"x1/2"	20	1	€ 0,46
06832 0605	1"x3/4"	20	1	€ 0,59
06832 0706	1"1/4x1"	20	1	€ 0,78
06832 0806	1"1/2x1"	10	1	€ 0,95
06832 0807	1"1/2x1"1/4	10	1	€ 1,13
06832 0908	2"x1"1/2	10	1	€ 1,83
06832 1009	2"1/2x2"	5	1	€ 6,53
06832 1109	3"x2"	1	1	€ 7,13
06832 1110	3"x2"1/2	1	1	€ 7,26
06832 1211	4"x3"	1	1	€ 12,20



## GOMITO A 90° FILETTATO FEMMINA

CODICE	DESCRIZIONE	CF	M.V.	PREZZO
06821 0404	1/2"	20	1	€ 1,20
06821 0505	3/4"	20	1	€ 1,35
06821 0606	1"	20	1	€ 1,74
06821 0707	1"1/4	10	1	€ 3,01
06821 0808	1"1/2	5	1	€ 5,81
06821 0909	2"	2	1	€ 8,00



## TEE A 90° FILETTATO FEMMINA

CODICE	DESCRIZIONE	CF	M.V.	PREZZO
06853 0400	1/2"	20	1	€ 1,65
06853 0500	3/4"	10	1	€ 1,82
06853 0600	1"	10	1	€ 2,24
06853 0700	1"1/4	10	1	€ 3,38
06853 0800	1"1/2	5	1	€ 7,01
06853 0900	2"	2	1	€ 10,05



# F21 - RACCORDI POLIETILENE FILETTATI



## TAPPO FILETTATO

CODICE	DESCRIZIONE	CF	M.V.	PREZZO
06862 0400	1/2"	50	1	€ 0,41
06862 0500	3/4"	20	1	€ 0,46
06862 0600	1"	20	1	€ 0,58
06862 0700	1"1/4	20	1	€ 1,18
06862 0800	1"1/2	20	1	€ 2,04
06862 0900	2"	10	1	€ 2,75
06862 1000	2"1/2	1	1	€ 6,80
06862 1100	3"	1	1	€ 8,56
06862 1200	4"	1	1	€ 13,64



## CALOTTA FILETTATA

CODICE	DESCRIZIONE	CF	M.V.	PREZZO
06860 0400	1/2"	20	1	€ 0,37
06860 0500	3/4"	20	1	€ 0,43
06860 0600	1"	20	1	€ 0,43
06860 0700	1"1/4	20	1	€ 0,79
06860 0800	1"1/2	20	1	€ 3,04
06860 0900	2"	10	1	€ 3,63
06860 1000	2"1/2	1	1	€ 7,93
06860 1100	3"	1	1	€ 9,35
06860 1200	4"	1	1	€ 17,14



## PRESA A STAFFA POLIETILENE

CODICE	DESCRIZIONE	CF	M.V.	PREZZO
06866 2505	25 x 3/4	1	1	€ 1,62
06866 3204	32 x 1/2	1	1	€ 1,85
06866 3205	32 x 3/4	1	1	€ 1,85
06866 4005	40 x 3/4	1	1	€ 2,05
06866 4006	40 x 1"	1	1	€ 2,05
06866 5005	50 x 3/4	1	1	€ 2,25
06866 5006	50 x 1"	1	1	€ 2,25



## COLLETTORE POLIETILENE

CODICE	DESCRIZIONE	CF	M.V.	PREZZO
06868 0200	1" x 2 vie	1	1	€ 16,75
06868 0300	1" x 3 vie	1	1	€ 23,74
06868 0400	1" x 4 vie	1	1	€ 30,92

## POP-UP BASSO

CODICE	DESCRIZIONE	CF	M.V.	PREZZO
06870 0000	alza 5 cm	100	1	€ 5,93

- Con testina 15 A



**New**

## POP-UP

CODICE	DESCRIZIONE	CF	M.V.	PREZZO
06872 0000	alza 10 cm	100	1	€ 5,13

- Con testina 15 A



**New**

## TESTINA PER POP-UP

CODICE	DESCRIZIONE	CF	M.V.	PREZZO
06874 0800	8A marrone	10	1	€ 3,17
06874 1000	10A rossa mt. 2,5	10	1	€ 3,17
06874 1200	12A verde mt. 3,5	10	1	€ 3,17
06874 1500	15A nera mt. 4	10	1	€ 3,17
06874 1700	17A beige	10	1	€ 3,17



**New**

## ELETTROVALVOLE POLIETILENE

CODICE	DESCRIZIONE	CF	M.V.	PREZZO
06880 0000	1"	1	1	€ 42,92



**New**

**New**



## POZZETTO GIARDINAGGIO VERDE STANDARD

CODICE	DESCRIZIONE	CF	M.V.	PREZZO
06882 0000	L16" x P11" x H12"	1	1	€ 26,50

**New**



## PROGRAMMATORE GREEN EVO ANALOGICO

CODICE	DESCRIZIONE	CF	M.V.	PREZZO
06884 0000	monostazione	1	1	€ 47,50



**New**



## CENTRALINA PER ELETTROVALVOLE

CODICE	DESCRIZIONE	CF	M.V.	PREZZO
06886 0400	4 stazioni	1	1	€ 130,00
06886 0600	6 stazioni	1	1	€ 141,75

**New**



## IRRIGATORE A SETTORI

CODICE	DESCRIZIONE	CF	M.V.	PREZZO
06888 0000	1/2	1	1	€ 4,82

- Con regolazione distanza e settore.

# F23 - RACCORDI POLIETILENE PORTAGOMMA

## MANICOTTO PORTA GOMMA

CODICE	DESCRIZIONE	CF	M.V.	PREZZO
06970 1616	∅ 16	100	1	€ 0,23

**New**



## MANICOTTO PORTA GOMMA CON GOMMINO

CODICE	DESCRIZIONE	CF	M.V.	PREZZO
06972 1600	∅ 16	10	1	€ 0,27

**New**



## GOMITO PORTA GOMMA FILETTATO MASCHIO

CODICE	DESCRIZIONE	CF	M.V.	PREZZO
06974 1604	∅ 16 x 1/2	50	1	€ 0,44

**New**



## TES PORTA GOMMA

CODICE	DESCRIZIONE	CF	M.V.	PREZZO
06976 1600	∅ 16	100	1	€ 0,28

**New**



# F23 - VALVOLE POLIETILENE PORTAGOMMA

**New**



## VALVOLA A CILINDRO PORTA GOMMA

CODICE	DESCRIZIONE	CF	M.V.	PREZZO
06890 1600	16 x 16	50	1	€ 1,64

**New**



## VALVOLA A CILINDRO PORTA GOMMA C/GOMMINO

CODICE	DESCRIZIONE	CF	M.V.	PREZZO
06892 1600	16 c/deviazione	50	1	€ 1,64

**New**



## VALVOLA A CILINDRO PER TAPE C/GOMMINO

CODICE	DESCRIZIONE	CF	M.V.	PREZZO
06894 0000	per manichetta Ø 16	50	1	€ 1,64

**New**



## VALVOLA A CILINDRO PER ALA GOCCOLANTE C/GOMMINO

CODICE	DESCRIZIONE	CF	M.V.	PREZZO
06896 0000	per ala Ø 16	50	1	€ 1,64

## VALVOLA A SFERA FF PVC

CODICE	DESCRIZIONE	CF	M.V.	PREZZO
06816 0500	3/4	1	1	€ 4,70
06816 0600	1"	1	1	€ 4,70
06816 0700	1-1/4	1	1	€ 14,80
06816 0800	1-1/2	1	1	€ 21,40
06816 0900	2"	1	1	€ 26,80

**New**



## VALVOLA FILETTATA FEMMINA

CODICE	DESCRIZIONE	CF	M.V.	PREZZO
06818 0400	1/2"	80	1	€ 10,44
06818 0500	3/4"	40	1	€ 12,64
06818 0600	1"	30	1	€ 17,53
06818 0700	1"1/4	20	1	€ 29,33
06818 0800	1"1/2	8	1	€ 41,39
06818 0900	2"	7	1	€ 65,76
06818 1000	2"1/2	5	1	€ 135,99
06818 1100	3"	3	1	€ 182,47
06818 1200	4"	2	1	€ 290,05



## SARACINESCA OTTONE FF PN16

CODICE	DESCRIZIONE	CF	M.V.	PREZZO
04212 0700	1 - 1/4	12	1	€ 28,20
04212 0800	1 - 1/2	8	1	€ 54,50
04212 0900	2"	2	1	€ 56,70
04212 1000	2 - 1/2	1	1	€ 86,50
04212 1100	3"	1	1	€ 105,00
04212 1200	4"	1	1	€ 205,60



## ATTACCO PER SERBATOIO

CODICE	DESCRIZIONE	CF	M.V.	PREZZO
06844 0400	1/2"	10	1	€ 5,60
06844 0500	3/4"	10	1	€ 5,55
06844 0600	1"	10	1	€ 7,19
06844 0700	1"1/2	10	1	€ 10,04
06844 0800	2"	10	1	€ 13,91





## TIPO PN PANETTONE

CODICE	Litri	Alt.	Lun.	Ø	Ap. isp.	RIF. F.	PREZZO
07000 0200	210	61	-	77	29	PN 200	€ 144,38
07000 0300	310	77	-	82	29	PN 300	€ 181,50
07000 0500	560	86	-	97	29	PN 500	€ 232,65
07000 0750	750	106	-	107	29	PN 750	€ 312,68
07000 1000	1020	106	-	116	39	PN 1000	€ 340,73
07000 1500	1520	145	-	122	39	PN 1500	€ 534,60
07000 2000	2120	144	-	147	39	PN 2000	€ 702,08
07000 3000	3220	125	-	195	39	PN 3000	€ 966,90
07000 5000	5300	194	-	193	39	PN 5000	€ 1487,48
07000 9999	10000	230	-	242	39	PN 10000	€ 2976,60

**Descrizione:** Botola grande - passo uomo dal PN 1000 in poi



## TIPO PNB PANETTONE BASSO

CODICE	Litri	Alt.	Lun.	Ø	Ap. isp.	RIF. F.	PREZZO
07002 0500	510	53	-	130	29	PNB 500	€ 232,65
07002 1000	1020	87	-	136	29	PNB 1000	€ 340,73
07002 1500	1520	123	-	136	39	PNB 1500	€ 534,60

**Descrizione:** Botola grande - passo uomo dal PNB 1000 in poi



## TIPO CO CILINDRICO ORIZZONTALE

CODICE	Litri	Alt.	Lun.	Lar.	Ap. isp.	RIF. F.	PREZZO
07010 0300	360	72	122	62	29	CO 300	€ 221,93
07010 0500	530	89	117	78	29	CO 500	€ 338,25
07010 0800	800	94	156	83	29	CO 800	€ 394,35
07010 1000	940	95	166	86	29	CO 1000	€ 424,88
07010 1001	1090	113	138	103	39	COA 1000	€ 477,00
07010 1002	1030	100	179	86	39	COB 1000	€ 477,00
07010 1500	1620	124	173	112	39	CO 1500	€ 707,36
07010 2000	2120	133	184	118	39	CO 2000	€ 886,05
07010 3000	3200	157	201	146	39	CO 3000	€ 1413,23
07010 5000	4700	174	229	164	39	CO 5000	€ 2069,93

**Descrizione:** Botola grande - passo uomo dal COA 1000 e dal COB 1000 in poi



## TIPO CV CILINDRO VERTICALE

CODICE	Litri	Alt.	Lun.	Lar.	Ap. isp.	RIF. F.	PREZZO
07020 0050	50	56	-	49	29	CV 50	€ 88,28
07020 0100	108	77	-	49	29	CV 100	€ 112,20
07020 0150	150	106	-	49	29	CV 150	€ 132,83
07020 0200	210	89	-	60	29	CV 200	€ 147,68
07020 0300	330	123	-	61	29	CV 300	€ 192,23
07020 0500	530	139	-	72	29	CV 500	€ 262,50
07020 1001	1020	226	-	76	29	CVAS 1000	€ 421,00
07020 1002	1020	205	-	81	29	CVA 1000	€ 421,00
07020 1000	1020	152	-	96	29	CV 1000	€ 421,00
07020 1500	1650	170	-	112	39	CV 1500	€ 691,35
07020 2000	2000	176	-	126	39	CV 2000	€ 832,43
07020 3000	3200	207	-	147	39	CV 3000	€ 1249,05
07020 5000	4720	220	-	175	39	CV 5000	€ 1592,25

**Descrizione:** Comprimibile fino a 10 cm

## TIPO LB LINEARE BASSO

CODICE	Litri	Alt.	Lun.	Lar.	Ap. isp.	RIF. F.	PREZZO
07030 0200	230	59	79	57	29	LB 200	€ 201,14
07030 0300	320	56	103	67	29	LB 300	€ 221,93
07030 0500	520	69	106	84	29	LB 500	€ 334,95



## TIPO LM LINEARE MEDIO

CODICE	Litri	Alt.	Lun.	Lar.	Ap. isp.	RIF. F.	PREZZO
07032 0300	320	72	100	57	29	LM 300	€ 221,93
07032 0500	520	95	106	59	29	LM 500	€ 334,95



## TIPO LA LINEARE ALTO

CODICE	Litri	Alt.	Lun.	Lar.	Ap. isp.	RIF. F.	PREZZO
07034 0200	230	90	57	52	29	LA 200	€ 201,14
07034 0300	330	92	67	61	29	LA 300	€ 221,93
07034 0500	520	118	82	60	29	LA 500	€ 334,95



## TIPO SOTTOSCALA

CODICE	Litri	Alt.	Lun.	Lar.	RIF. F.	PREZZO
07038 0500	500	80	125	68	Sottoscala 5	€ 371,25

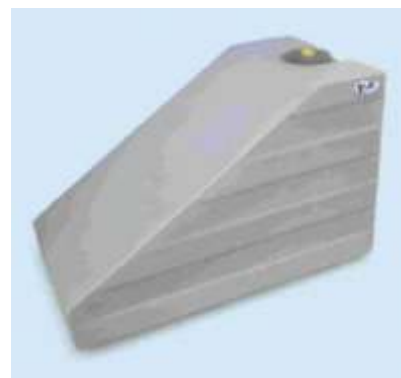



## TIPO OR OROLOGIO

CODICE	Litri	Alt.	Lun.	Lar.	Ap. isp.	RIF. F.	PREZZO
07040 0300	310	106	98	49/39	29	OR 300	€ 251,63
07040 0500	550	127	116	51/41	29	OR 500	€ 311,03
07040 1000	950	140	140	69/60	29	OR 1000	€ 498,00

**Descrizione:** Comprimibile fino a 10 cm



## TIPO RA RETTANGOLO ALTO

CODICE	Litri	Alt.	Lun.	Lar.	Ap. isp.	RIF. F.	PREZZO
07042 0500	500	106	97	59	29	RA 500	€ 364,65
07042 0750	790	116	123	69	29	RA 750	€ 415,80
07042 1000	1000	137	135	69	29	RA 1000	€ 572,55
07042 2000	1800	224	124	70	29	RA 2000	€ 1.564,20

## TIPO AR ANGOLARE RETTO



CODICE	Litri	Alt.	Lun.	Lar.	Ap. isp.	RIF. F.	PREZZO
07046 0500	540	146	68	68	29	AR 500	€ 386,10



## TIPO CO DA TRASPORTO

CODICE	Litri	Alt.	Lun.	Lar.	Ap. isp.	RIF. F.	PREZZO
07048 3600	3600	138	220	167	39	CO 3600	€ 2.024,55

**Descrizione:** Comprimibile fino a 10 cm

## CONTENITORE NERVATO DA INTERRO

CODICE	C.tà	H mmxØmm	Ap. isp. 1	Ap. isp. 2	RIF. F.	PREZZO
07050 1000	1040	1150x1200	370	170	IV 1000	€ 1.284,53
07050 1500	1420	1500x1200	370	170	IV 1500	€ 1.584,00
07050 2000	1970	2050x1200	370	170	IV 2000	€ 2.055,90
07050 3000	3000	1550x1800	370	170	IV 3000	€ 2.569,05
07050 4000	4000	2070x1650	370	170	IV 4000	€ 3.585,45
07050 5000	5000	2425x1800	370	170	IV 5000	€ 4.403,03



## CONTENITORE NERVATO DA INTERRO

CODICE	C.tà	H mmxØmm	Ap. isp. 1	Ap. isp. 2	RIF. F.	PREZZO
07052 5000	5000	1890x2050	39	--	PNI 5000	€ 3.133,35
07052 0000		56x45	--	--	PROLUNGA C	€ 271,76



## SERBATOIO DA INTERRO PANETTONE RINFORZATO VETRORESINA

CODICE	Alt.	Alt. x Lun. x Lar.	RIF. F.	PREZZO
07054 2000	2120	144x147	PNV 2000	€ 1.869,45
07054 3000	3220	124x195	PNV 3000	€ 2.392,34
07054 5300	5300	193x195	PNV 5300	€ 3.577,20
07054 8000	8000	199x245	PNV 8000	€ 5.162,85
07054 9999	1000	230x245	PNV 10000	€ 7.076,03

- Interno polietilene alimentare, esterno tutto vetroresina



## FOSSA IMHOFF MOD. 6-9

CODICE	Litri	Alt.	Ø	Persone	RIF. F.	PREZZO
07060 1500	1500	140	140	6-7/11-12	FS 1500	€ 1.126,95
07060 2000	2000	170	165	9-10/16-17	FS 2000	€ 1.483,35
07060 0001		50	25		PROLUNGA A	€ 132,00
07060 0002		50	35		PROLUNGA B	€ 161,70

- Costruite secondo le direttive della Legge n° 319/76



**VALVOLE RITEGNO IN OTTONE**



**RACCORDI IN OTTONE**



**MULTISTRATO**



**ZINCATO**



**P<sub>PR</sub>**



**POLIETILENE**



**SERBATOI POLIETILENE**

TUBI DI SCARICO IN PPS  
SIGILLANTI E  
ATTREZZATURE IDRAULICHE

*La serenità è quando ciò che pensi,  
ciò che dici e ciò che sei  
sono in armonia.*

*Mohandas Karamchard Gandhi*

**SOUDAL**

**MGF**

**FACOT**  
CHEMICALS

**BAMPI**

**CAMON**

**RUSSO TERMIDRAULICA**



**TEFLON**



**SIGILLANTI**



**PRODOTTI CHIMICI**



**ATTREZZATURE DISOSTRUENTE**



**TUBI E RACCORDI PPS GRIGIO**

## TUBO PPS CON 1 BICCHIERE DM 32

CODICE	DESCRIZIONE	CF	M.V.	PREZZO
07106 0500	DN 32 L mm. 500	20	1	€ 3,00
07106 1000	DN 32 L mm. 1000	10	1	€ 4,75
07106 2000	DN 32 L mm. 2000	10	1	€ 8,68
07106 3000	DN 32 L mm. 3000	10	1	€ 12,94



## TUBO PPS CON 1 BICCHIERE DM 40

CODICE	DESCRIZIONE	CF	M.V.	PREZZO
07107 0500	DN 40 L mm. 500	20	1	€ 2,31
07107 1000	DN 40 L mm. 1000	10	1	€ 3,82
07107 2000	DN 40 L mm. 2000	10	1	€ 7,45
07107 3000	DN 40 L mm. 3000	10	1	€ 10,78



## TUBO PPS CON 1 BICCHIERE DM 50

CODICE	DESCRIZIONE	CF	M.V.	PREZZO
07108 0500	DN 50 L mm. 500	20	1	€ 2,86
07108 1000	DN 50 L mm. 1000	10	1	€ 4,80
07108 2000	DN 50 L mm. 2000	10	1	€ 9,38
07108 3000	DN 50 L mm. 3000	10	1	€ 13,84



## TUBO PPS CON 1 BICCHIERE DM 75

CODICE	DESCRIZIONE	CF	M.V.	PREZZO
07120 1000	DN 75 L mm 1000	4	1	€ 6,82
07120 2000	DN 75 L mm 2000	4	1	€ 13,32
07120 3000	DN 75 L mm 3000	4	1	€ 18,90



# G1 - TUBI E RACCORDI PPS



## TUBO PPS CON 2 BICCHIERI DM 90

CODICE	DESCRIZIONE	CF	M.V.	PREZZO
07103 0500	DN 90 L mm. 500	15	1	€ 9,60
07103 1000	DN 90 L mm. 1000	4	1	€ 15,92
07103 2000	DN 90 L mm. 2000	4	1	€ 25,08
07103 3000	DN 90 L mm. 3000	4	1	€ 37,44



## TUBO PPS CON 1 BICCHIERE DM 110

CODICE	DESCRIZIONE	CF	M.V.	PREZZO
07111 0500	DN 110 L mm. 500	10	1	€ 7,84
07111 1000	DN 110 L mm. 1000	4	1	€ 13,24
07111 2000	DN 110 L mm. 2000	4	1	€ 26,60
07111 3000	DN 110 L mm. 3000	4	1	€ 40,98



## TUBO PPS CON 1 BICCHIERE DM 125

CODICE	DESCRIZIONE	CF	M.V.	PREZZO
07113 1000	DN 125 L mm. 1000	4	1	€ 25,86
07113 2000	DN 125 L mm. 2000	4	1	€ 45,71
07113 3000	DN 125 L mm. 3000	4	1	€ 64,26



## TUBO PPS CON 1 BICCHIERE DM 90

CODICE	DESCRIZIONE	CF	M.V.	PREZZO
07109 0500	DN 90 L mm. 500	15	1	€ 8,01
07109 1000	DN 90 L mm. 1000	4	1	€ 13,18
07109 2000	DN 90 L mm. 2000	4	1	€ 24,11
07109 3000	DN 90 L mm. 3000	4	1	€ 36,93

## TUBO PPS CON 2 BICCHIERI DM 32

CODICE	DESCRIZIONE	CF	M.V.	PREZZO
07100 0500	DN 32 L mm. 500	20	1	€ 3,91
07100 1000	DN 32 L mm. 1000	10	1	€ 5,29
07100 2000	DN 32 L mm. 2000	10	1	€ 9,53
07100 3000	DN 32 L mm. 3000	10	1	€ 12,51



## TUBO PPS CON 2 BICCHIERI DM 40

CODICE	DESCRIZIONE	CF	M.V.	PREZZO
07101 0500	DN 40 L mm. 500	70	1	€ 2,87
07101 1000	DN 40 L mm. 1000	10	1	€ 4,43
07101 2000	DN 40 L mm. 2000	10	1	€ 7,75
07101 3000	DN 40 L mm. 3000	10	1	€ 11,44



## TUBO PPS CON 2 BICCHIERI DM 50

CODICE	DESCRIZIONE	CF	M.V.	PREZZO
07102 0500	DN 50 L mm. 500	40	1	€ 3,69
07102 1000	DN 50 L mm. 1000	10	1	€ 5,16
07102 2000	DN 50 L mm. 2000	10	1	€ 10,22
07102 3000	DN 50 L mm. 3000	10	1	€ 15,04



## TUBO PPS CON 2 BICCHIERI DM 75

CODICE	DESCRIZIONE	CF	M.V.	PREZZO
07128 1000	DN 75 L mm. 1000	4	1	€ 8,90
07128 2000	DN 75 L mm. 2000	4	1	€ 16,40
07128 3000	DN 75 L mm. 3000	4	1	€ 23,75



# G1 - TUBI E RACCORDI PPS



## TUBO PPS CON 2 BICCHIERI DM 90

CODICE	DESCRIZIONE	CF	M.V.	PREZZO
07103 0500	DN 90 L mm. 500	15	1	€ 9,60
07103 1000	DN 90 L mm. 1000	4	1	€ 15,92
07103 2000	DN 90 L mm. 2000	4	1	€ 25,08
07103 3000	DN 90 L mm. 3000	4	1	€ 37,44



## TUBO PPS CON 2 BICCHIERI DM 110

CODICE	DESCRIZIONE	CF	M.V.	PREZZO
07104 0500	DN 110 L mm. 500	10	1	€ 11,47
07104 1000	DN 110 L mm. 1000	4	1	€ 15,97
07104 2000	DN 110 L mm. 2000	4	1	€ 28,43
07104 3000	DN 110 L mm. 3000	4	1	€ 41,13



## TUBO PPS CON 2 BICCHIERI DM 125

CODICE	DESCRIZIONE	CF	M.V.	PREZZO
07105 1000	DN 125 L mm 1000	4	1	€ 29,71
07105 2000	DN 125 L mm. 2000	4	1	€ 48,66
07105 3000	DN 125 L mm. 3000	4	1	€ 65,73

## MANICOTTO PPS

CODICE	DESCRIZIONE	CF	M.V.	PREZZO
07110 0032	DN 32 L. mm. 86	50	1	€ 2,76
07110 0040	DN 40 L. mm. 125	20	1	€ 2,26
07110 0050	DN 50 L. mm. 125	20	1	€ 2,73
07110 0090	DN 90 L. mm. 100	20	1	€ 5,69
07110 0110	DN 110 L. mm. 170	20	1	€ 6,18



## MANICOTTO DI PROLUNGAMENTO WC

CODICE	DESCRIZIONE	CF	M.V.	PREZZO
07112 0090	DN D 90 L. mm. 180	16	1	€ 7,90
07112 2090	DN D 90 L. mm. 250	16	1	€ 7,90
07112 0100	DN D 100 L. mm. 180	18	1	€ 6,80
07112 2100	DN D 100 L. mm. 250	16	1	€ 6,80
07112 2110	DN D 110 L. mm. 250	25	1	€ 11,66
07112 0110	DN D 110 L. mm. 350	12	1	€ 22,75



## ROSONE PER TRONCHETTO PPS

CODICE	DESCRIZIONE	CF	M.V.	PREZZO
07114 0090	∅ 90	1	1	€ 4,20
07114 0100	∅ 100	1	1	€ 4,20
07114 0110	∅ 110	1	1	€ 4,20



## VALVOLA ANTIRIFLESSO C/GUARNIZIONE

CODICE	DESCRIZIONE	CF	M.V.	PREZZO
07174 0100	∅100	1	1	€ 111,84
07174 0110	∅110	1	1	€ 118,42
07174 0125	∅125	1	1	€ 125,00

- In PVC colore mattone RAL 8023.





## RACCORDO in PVC di passaggio da PPS a PVC FM

CODICE	DESCRIZIONE	CF	M.V.	PREZZO
07115 4040	DN D/D1 40/40 L. mm. 65	30	1	€ 4,39
07115 5050	DN D/D1 50/50 L. mm. 65	20	1	€ 4,94



## RACCORDO in PVC di passaggio da PPS a PVC incollaggio

CODICE	DESCRIZIONE	CF	M.V.	PREZZO
07116 9010	DN D/D1 90/100 L. mm. 69	10	1	€ 10,13
07116 1011	DN D/D1 100/110 L. mm. 61	20	1	€ 10,29
07116 1112	DN D/D1 110/125 L. mm. 95	25	1	€ 13,34

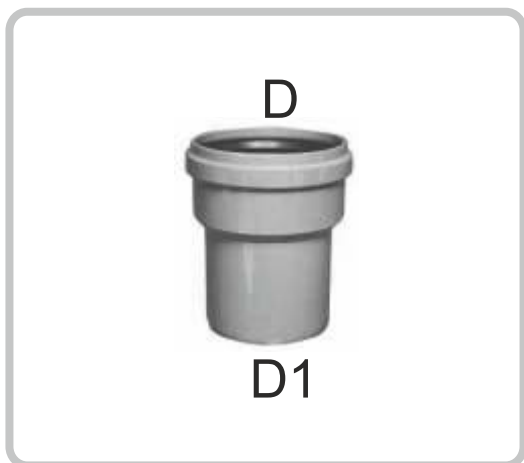

## RACCORDO di passaggio da PVC incollaggio a PPS

CODICE	DESCRIZIONE	CF	M.V.	PREZZO
07118 1090	DN D/D1 100/90 L. mm. 66	10	1	€ 11,08
07118 1110	DN D/D1 110/100 L. mm. 80	20	1	€ 10,36
07118 1211	DN D/D1 125/110 L. mm. 70	5	1	€ 16,78



## RACCORDO di passaggio da PPS a PVC incollaggio lungo

CODICE	DESCRIZIONE	CF	M.V.	PREZZO
07119 1110	DN D/D1 110/100 L. mm. 250	3	1	€ 19,16



## CURVA DM 32 PPS

CODICE	DESCRIZIONE	CF	M.V.	PREZZO
07123 1500	DN 32 Angolo 15°	50	1	€ 1,50
07123 3000	DN 32 Angolo 30°	50	1	€ 1,50
07123 4500	DN 32 Angolo 45°	50	1	€ 1,49
07123 6700	DN 32 Angolo 67°	50	1	€ 1,49
07123 8700	DN 32 Angolo 87½°	50	1	€ 1,49



## CURVA DM 40 PPS

CODICE	DESCRIZIONE	CF	M.V.	PREZZO
07124 1500	DN 40 Angolo 15°	20	1	€ 1,32
07124 3000	DN 40 Angolo 30°	20	1	€ 1,32
07124 4500	DN 40 Angolo 45°	20	1	€ 1,23
07124 6700	DN 40 Angolo 67°	20	1	€ 1,23
07124 8700	DN 40 Angolo 87½°	20	1	€ 1,23



## CURVA DM 50 PPS

CODICE	DESCRIZIONE	CF	M.V.	PREZZO
07125 1500	DN 50 Angolo 15°	20	1	€ 1,68
07125 3000	DN 50 Angolo 30°	20	1	€ 1,68
07125 4500	DN 50 Angolo 45°	20	1	€ 1,58
07125 6700	DN 50 Angolo 67°	20	1	€ 1,68
07125 8700	DN 50 Angolo 87½°	20	1	€ 1,68



## CURVA DM 75 PPS

CODICE	DESCRIZIONE	CF	M.V.	PREZZO
07127 1500	DN 75 Angolo 15°	20	1	€ 3,20
07127 3000	DN 75 Angolo 30°	20	1	€ 3,30
07127 4500	DN 75 Angolo 45°	20	1	€ 2,97
07127 8700	DN 75 Angolo 87½°	20	1	€ 2,97





## CURVA DM 90 PPS

CODICE	DESCRIZIONE	CF	M.V.	PREZZO
07129 1500	DN 90 Angolo 15°	20	1	€ 4,54
07129 3000	DN 90 Angolo 30°	20	1	€ 4,49
07129 4500	DN 90 Angolo 45°	20	1	€ 4,40
07129 6700	DN 90 Angolo 67°	20	1	€ 4,40
07129 8700	DN 90 Angolo 87½°	20	1	€ 4,40



## CURVA DM 110 PPS

CODICE	DESCRIZIONE	CF	M.V.	PREZZO
07121 1500	DN 110 Angolo 15°	20	1	€ 4,96
07121 3000	DN 110 Angolo 30°	20	1	€ 4,96
07121 4500	DN 110 Angolo 45°	20	1	€ 4,93
07121 6700	DN 110 Angolo 67°	20	1	€ 4,93
07121 8700	DN 110 Angolo 87½°	20	1	€ 4,93



## CURVA DM 125 PPS

CODICE	DESCRIZIONE	CF	M.V.	PREZZO
07122 4500	DN 125 Angolo 45°	20	1	€ 12,17
07122 8700	DN 125 Angolo 87½°	10	1	€ 12,17



## CURVA DM 160 PPS

CODICE	DESCRIZIONE	CF	M.V.	PREZZO
07126 4500	DN 160 Angolo 45°	10	1	€ 26,26
07126 8700	DN 160 Angolo 87½°	10	1	€ 26,26



## CURVA FF Ø 40 PPS

CODICE	DESCRIZIONE	CF	M.V.	PREZZO
07164 1500	DM 40 - 15°	70	1	€ 3,35
07164 3000	DM 40 - 30°	70	1	€ 3,35
07164 4500	DM 40 - 45°	70	1	€ 2,89
07164 8700	DM 40 - 87°	70	1	€ 2,89



## CURVA FF Ø 50 PPS

CODICE	DESCRIZIONE	CF	M.V.	PREZZO
07165 1500	DM 50 - 15°	50	1	€ 3,71
07165 3000	DM 50 - 30°	50	1	€ 3,71
07165 4500	DM 50 - 45°	50	1	€ 3,41
07165 8700	DM 50 - 87°	45	1	€ 3,41



## CURVA FF Ø 90 PPS

CODICE	DESCRIZIONE	CF	M.V.	PREZZO
07169 1500	DM 90 - 15°	15	1	€ 8,64
07169 3000	DM 90 - 30°	15	1	€ 8,64
07169 4500	DM 90 - 45°	15	1	€ 8,64
07169 8700	DM 90 - 87°	10	1	€ 8,64



## CURVA FF Ø 110 PPS

CODICE	DESCRIZIONE	CF	M.V.	PREZZO
07161 1500	DM 110 - 45°	20	1	€ 9,85
07161 3000	DM 110 - 87°	20	1	€ 9,85





## CURVA TECNICA PPS

CODICE	DESCRIZIONE	CF	M.V.	PREZZO
07130 0040	Ø 40 x 40	20	1	€ 2,05
07130 0050	Ø 50 x 50	20	1	€ 1,89
07130 4050	Ø 40 x 50	20	1	€ 1,89



## CURVA BIANCA WC A COLLO DI CIGNO

CODICE	DESCRIZIONE	CF	M.V.	PREZZO
07134 0090	DN D 90 Angolo 90° c/morsetto	12	1	€ 11,44



## CURVA BIANCA WC A COLLO DI CIGNO

CODICE	DESCRIZIONE	CF	M.V.	PREZZO
07132 0090	DN D 90 Angolo 90°	12	1	€ 9,12
07132 0100	DN D 100 Angolo 90°	12	1	€ 9,12
07132 0110	DN D 110 Angolo 90°	12	1	€ 9,12



## CURVA BIANCA PROLUNGATA WC

CODICE	DESCRIZIONE	CF	M.V.	PREZZO
07136 0090	DN D 90 Angolo 90°	20	1	€ 13,40
07136 0110	DN D 110 Angolo 90°	25	1	€ 14,08

## CURVA BIANCA PROLUNGATA WC C/2 ATTACCHI

CODICE	DESCRIZIONE	CF	M.V.	PREZZO
07138 1150	110/50/50 destro/sinistro	18	1	€ 29,65



## CURVA BIANCA PROLUNGATA WC C/1 ATTACCO

CODICE	DESCRIZIONE	CF	M.V.	PREZZO
07139 9050	90/50 sinistro	10	1	€ 22,39
07139 9051	90/50 destro	10	1	€ 22,39
07139 1150	110/50 sinistro	18	1	€ 22,14
07139 1151	110/50 destro	18	1	€ 22,14



## CURVA BIANCA PROLUNGATA WC ORIENTABILE

CODICE	DESCRIZIONE	CF	M.V.	PREZZO
07137 9040	90 x 40	10	1	€ 24,65
07137 9050	90 x 50	10	1	€ 25,96
07137 1150	110 x 50	10	1	€ 27,12

- Orientabile sia a DX che a SX.



## RIDUZIONE SPECIALE ECCENTRICA

CODICE	DESCRIZIONE	CF	M.V.	PREZZO
07146 4032	DN D/D1 40/32	25	1	€ 3,90
07146 5040	DN D/D1 50/40	20	1	€ 3,03
07146 1190	DN D/D1 110/90	20	1	€ 7,02

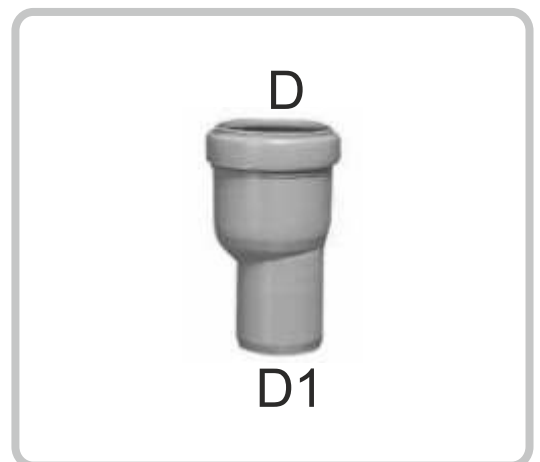

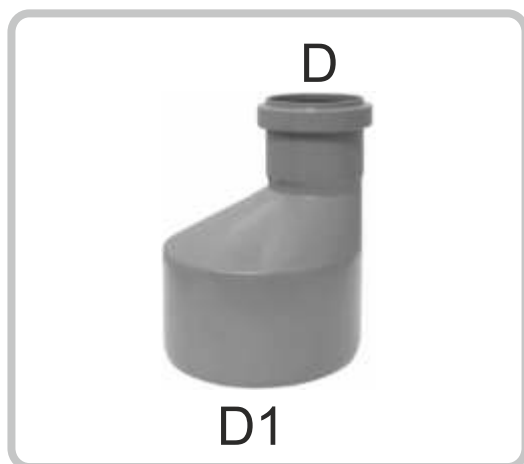

## AUMENTO

CODICE	DESCRIZIONE	CF	M.V.	PREZZO
07142 3240	D/D1 32/40	30	1	€ 2,73
07142 3250	D/D1 32/50	20	1	€ 2,78
07142 4050	D/D1 40/50	20	1	€ 1,52
07142 4090	D/D1 40/90	20	1	€ 5,57
07142 4011	D/D1 40/110	20	1	€ 4,50
07142 5090	D/D1 50/90	20	1	€ 3,70
07142 5011	D/D1 50/110	20	1	€ 4,07
07142 7511	D/D1 75/110	20	1	€ 4,99
07142 9011	D/D1 90/110	20	1	€ 4,99
07142 1112	D/D1 110/125	20	1	€ 11,13
07142 1116	D/D1 110/160	20	1	€ 17,79
07142 1216	D/D1 125/160	20	1	€ 23,23

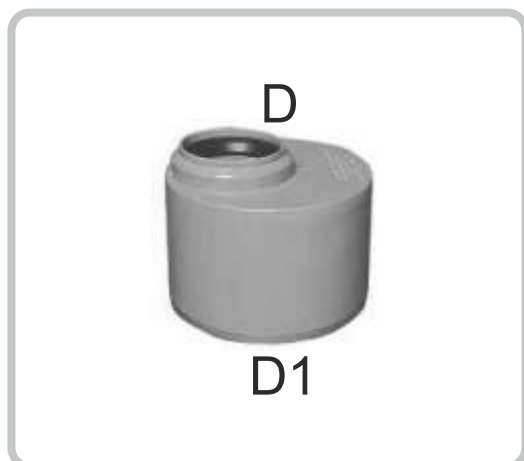

## AUMENTO CORTO

CODICE	DESCRIZIONE	CF	M.V.	PREZZO
07144 3240	DN D/D1 32/40	50	1	€ 2,63
07144 4050	DN D/D1 40/50	50	1	€ 2,63
07144 4075	DN D/D1 40/75	20	1	€ 3,90
07144 5075	DN D/D1 50/75	20	1	€ 3,87
07144 4090	DN D/D1 40/90	20	1	€ 5,03
07144 5090	DN D/D1 50/90	20	1	€ 3,75
07144 4011	DN D/D1 40/110	20	1	€ 4,54
07144 5011	DN D/D1 50/110	20	1	€ 4,06
07144 9011	DN D/D1 90/110	20	1	€ 5,89
07144 1112	DN D/D1 110/125	20	1	€ 9,20



## TAMPONE IN PPS CORTO CON 3 ENTRATE

CODICE	DESCRIZIONE	CF	M.V.	PREZZO
07145 0000	110 x 40 x 40 x 40	20	1	€ 14,00

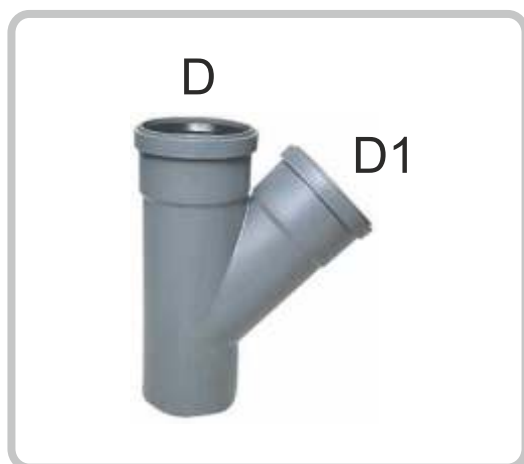

## BRAGA 45° PPS

CODICE	DESCRIZIONE	CF	M.V.	PREZZO
07150 3232	DN D/D1 32/32 Angolo 45°	30	1	€ 3,39
07150 4040	DN D/D1 40/40 Angolo 45°	20	1	€ 2,42
07150 5050	DN D/D1 50/50 Angolo 45°	20	1	€ 3,03
07150 7575	DN D/D1 75/75 Angolo 45°	20	1	€ 6,60
07150 9090	DN D/D1 90/90 Angolo 45°	20	1	€ 8,35
07150 1111	DN D/D1 110/110 Angolo 45°	10	1	€ 9,08
07150 1212	DN D/D1 125/125 Angolo 45°	5	1	€ 38,12
07150 1616	DN D/D1 160/160 Angolo 45°	5	1	€ 92,97

## BRAGA 45° RIDOTTA PPS

CODICE	DESCRIZIONE	CF	M.V.	PREZZO
07152 4032	DN D/D1 40/32 Angolo 45°	40	1	€ 5,69
07152 5040	DN D/D1 50/40 Angolo 45°	20	1	€ 2,78
07152 7540	DN D/D1 75/40 Angolo 45°	20	1	€ 5,77
07152 7550	DN D/D1 75/50 Angolo 45°	20	1	€ 5,85
07152 9040	DN D/D1 90/40 Angolo 45°	20	1	€ 6,12
07152 9050	DN D/D1 90/50 Angolo 45°	20	1	€ 5,69
07152 1140	DN D/D1 110/40 Angolo 45°	20	1	€ 6,00
07152 1150	DN D/D1 110/50 Angolo 45°	20	1	€ 6,00



## BRAGA 67° PPS

CODICE	DESCRIZIONE	CF	M.V.	PREZZO
07154 5050	DN D/D1 50/50 Angolo 67°	20	1	€ 4,91
07154 1150	DN D/D1 110/50 Angolo 67°	20	1	€ 7,05
07154 1111	DN D/D1 110/110 Angolo 67°	10	1	€ 8,51

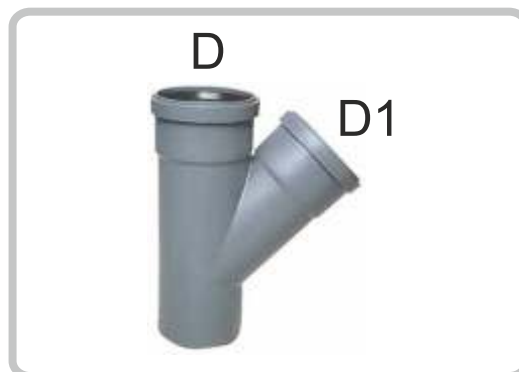

## BRAGA 87 1/2° PPS

CODICE	DESCRIZIONE	CF	M.V.	PREZZO
07156 3232	DN D/D1 32/32 Angolo 87½°	30	1	€ 3,55
07156 4040	DN D/D1 40/40 Angolo 87½°	20	1	€ 2,51
07156 5050	DN D/D1 50/50 Angolo 87½°	20	1	€ 3,15
07156 9090	DN D/D1 90/90 Angolo 87½°	20	1	€ 8,23
07156 1111	DN D/D1 110/110 Angolo 87½°	10	1	€ 9,08
07156 1212	DN D/D1 125/125 Angolo 87½°	5	1	€ 44,53
07156 1616	DN D/D1 160/160 Angolo 87½°	5	1	€ 96,07



## BRAGA 87 1/2° RIDOTTA PPS

CODICE	DESCRIZIONE	CF	M.V.	PREZZO
07158 9050	DN D/D1 90/50 Angolo 87½°	20	1	€ 7,57
07158 1140	DN D/D1 110/40 Angolo 87½°	20	1	€ 7,57
07158 1150	DN D/D1 110/50 Angolo 87½°	20	1	€ 7,38



## ISPEZIONE CON TAPPO A VITE PPS

CODICE	DESCRIZIONE	CF	M.V.	PREZZO
07159 0090	DN 90	20	1	€ 14,04
07159 0110	DN 110	20	1	€ 11,98





## GIUNTO RIPARAZIONE

CODICE	DESCRIZIONE	CF	M.V.	PREZZO
07170 0040	L. mm 163 - dm 40	20	1	€ 4,83
07170 0050	L. mm 163 - dm 50	20	1	€ 5,97
07170 0090	L. mm 197 - dm 90	20	1	€ 14,56
07170 0110	L. mm 257 - dm 110	20	1	€ 10,43



## TAPPO IN PP GRIGIO

CODICE	DESCRIZIONE	CF	M.V.	PREZZO
07160 0032	DN 32	40	1	€ 2,12
07160 0040	DN 40	20	1	€ 0,87
07160 0050	DN 50	20	1	€ 1,16
07160 0090	DN 90	20	1	€ 3,63
07160 0110	DN 110	20	1	€ 3,16
07160 0125	DN 125	10	1	€ 7,45



## SIFONE TIPO FIRENZE

CODICE	DESCRIZIONE	CF	M.V.	PREZZO
07172 0050	Ø 50	1	1	€ 36,69
07172 0075	Ø 75	1	1	€ 43,50
07172 0090	Ø 90	1	1	€ 54,21
07172 0110	Ø 110	1	1	€ 54,21
07172 0125	Ø 125	1	1	€ 116,52
07172 0160	Ø 160	1	1	€ 197,84



## SCIVOLINA

CODICE	DESCRIZIONE	CF	M.V.	PREZZO
07210 0000	250 ml	1	1	€ 5,82

# Il clima ideale con Bampi



cdvbampi©2026

SISTEMA RADIANTE A SOFFITTO  
SENZA INGRESSO DI OSSIGENO

CONTROLLO DI TUTTA L'IMPIANTISTICA INDOOR CON

SMARTOUCH



Sistemi evoluti classe V-VI-VIII BACS classe «B» UNI EN 15232

SISTEMA RADIANTE A PARETE  
SENZA INGRESSO DI OSSIGENO

GESTIONE IMPIANTISTICA CON COLLETTORE INOX BREVETTATO

EFOS



PORTATA VARIABILE

SISTEMA RADIANTE A PAVIMENTO  
SENZA INGRESSO DI OSSIGENO



## Specialisti della bassa inerzia

In Bampi ogni progetto di sistema radiante viene affrontato con l'obiettivo di assicurare il più elevato livello di benessere a coloro che vivranno gli ambienti.



FACILITÀ DI MONTAGGIO



MATERIALI ECOCOMPATIBILI



CERTIFICATO CAM

**BSPINN** consente di realizzare impianti radianti a pavimento in **solì 19 mm.\***

\* Finito a 25 mm. con livelline

\* Finito a 30 mm. con autolivellanti



# BAMPI

Sistemi radianti per tutti gli ambiti applicativi



MONORESIDENZIALE



PLURIRESIDENZIALE



RISTRUTTURAZIONE



TERZIARIO & UFFICI



INDUSTRIALE



## G3 - COLLARI CON TASSELLO



### COLLARE FERMA TUBO COMPLETO

CODICE	DESCRIZIONE	CF	M.V.	PREZZO
08110 0300	3/8	100	2	€ 0,91
08110 0400	1/2	100	2	€ 0,91
08110 0500	3/4	100	2	€ 0,97
08110 0600	1"	100	2	€ 0,97
08110 0700	1" 1/4	100	2	€ 1,05
08110 0800	1" 1/2	100	2	€ 1,16
08110 0900	2"	50	2	€ 1,26
08110 1000	2" 1/2	50	2	€ 2,00
08110 1100	3"	50	2	€ 2,89
08110 1200	4"	50	2	€ 3,15

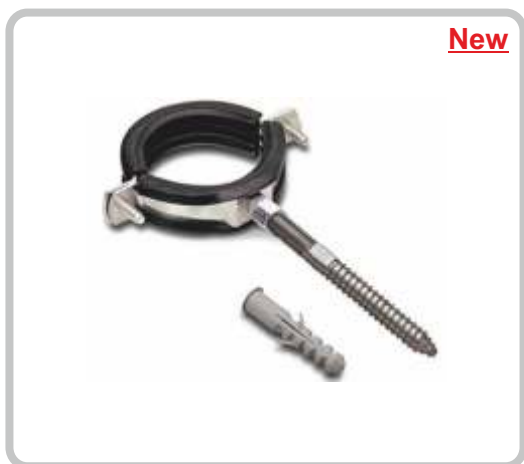

New

### COLLARE FERMA TUBO COMPLETO + GOMMA ANTIVIBRANTE

CODICE	DESCRIZIONE	CF	M.V.	PREZZO
08112 0400	1/2	100	2	€ 2,07
08112 0500	3/4	100	2	€ 2,25
08112 0600	1"	100	2	€ 2,35
08112 0700	1-1/4	100	2	€ 2,55
08112 0800	1-1/2	100	2	€ 2,59
08112 0900	2"	50	2	€ 3,00
08112 1000	2-1/2	50	2	€ 3,81
08112 1100	3"	50	2	€ 4,18
08112 1200	4"	50	2	€ 4,97

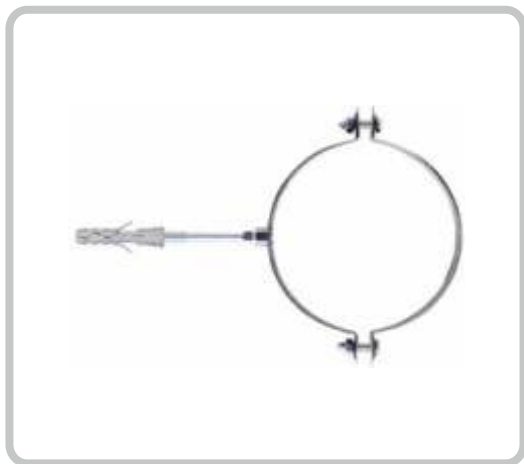

### COLLARE FERMA TUBO PER TUBO PLUVIALE

CODICE	DESCRIZIONE	CF	M.V.	PREZZO
08130 8000	tubo pluviale Ø 80	100	2	€ 1,50
08130 9000	tubo pluviale Ø 90 tipo pesante	50	2	€ 2,88
08130 1000	tubo pluviale Ø 100	100	2	€ 1,54
08130 1100	tubo pluviale Ø 110 tipo pesante	50	2	€ 3,11
08130 1200	tubo pluviale Ø 120	100	2	€ 1,55



### COLLARE LEGGERO IN RAME

CODICE	DESCRIZIONE	CF	M.V.	PREZZO
08120 1200	mm 12	10	10	€ 2,20
08120 1400	mm 14	10	10	€ 2,20
08120 1600	mm 16	10	10	€ 2,50
08120 1800	mm 18	10	10	€ 2,50
08120 2200	mm 22	10	10	€ 2,60
08120 2800	mm 28	10	10	€ 2,74

- Completo di perno e tassello

## STAFFA PESANTE A 1 FORO

CODICE	DESCRIZIONE	CF	M.V.	PREZZO
08150 1600	mm 16	100	1	€ 0,25
08150 2000	mm 20	100	1	€ 0,25
08150 2600	mm 26	100	1	€ 0,30
08150 3200	mm 32	100	1	€ 0,39



## STAFFA PESANTE A 2 FORI

CODICE	DESCRIZIONE	CF	M.V.	PREZZO
08151 1600	mm 16	100	1	€ 0,25
08151 2000	mm 20	100	1	€ 0,25
08151 2600	mm 26	100	1	€ 0,32
08151 3200	mm 32	100	1	€ 0,47



## COLLARINO SINGOLO IN POLIAMIDE

CODICE	DESCRIZIONE	CF	M.V.	PREZZO
08160 1600	16	10	1	€ 0,68
08160 2000	20	10	1	€ 1,02



## FISSATUBO CLIPS A FASCETTA

CODICE	DESCRIZIONE	CF	M.V.	PREZZO
08164 1632	16-32	1000	100	€ 0,425
08164 4063	40-63	1000	100	€ 0,700



**New**



## TASSELLI VITE GANCIO CORTO

CODICE	DESCRIZIONE	CF	M.V.	PREZZO
08185 0940	9X40 M4	100	100	€ 0,33
08185 1246	12X46	100	100	€ 0,42



**New**

## TASSELLI VITE GANCIO MEDIO

CODICE	DESCRIZIONE	CF	M.V.	PREZZO
08179 0940	9 x 40 - M 4	200	10	€ 0,36
08179 1246	12 x 43 - M 5	100	10	€ 0,46



## TASSELLI VITE GANCIO LUNGO

CODICE	DESCRIZIONE	CF	M.V.	PREZZO
08186 0940	9X40 M4	100	100	€ 0,37
08186 1246	12X46	100	100	€ 0,47



**New**

## TASSELLI IN ACCIAIO + VITE T.E. 8.8 E RONDELLA

CODICE	DESCRIZIONE	CF	M.V.	PREZZO
08192 0650	∅ 6 x 50 mm (DM 10)	100	10	€ 1,13
08192 0860	∅ 8 x 60 mm (DM 12)	50	10	€ 1,33
08192 1080	∅ 10 x 80 mm (DM 15)	25	5	€ 2,62
08192 1290	∅ 12 x 90 mm (DM 18)	25	5	€ 3,50

- Prezzo riferito al singolo pezzo.

## TASSELLO + VITE SECCHIELLO PICCOLO

CODICE	DESCRIZIONE	CF	M.V.	PREZZO
08142 0640	6 x 40	100	100	€ 6,80
08142 0845	8 x 45	50	50	€ 9,00
08142 1060	10 x 60	50	50	€ 13,60

- Tassello multiuso a 4 settori in nylon + vite TPS croce

Il prezzo si riferisce alla confezione,



## TASSELLO + VITE + PUNTA SECCHIELLO GRANDE

CODICE	DESCRIZIONE	CF	M.V.	PREZZO
08143 0640	6 x 40	300	300	€ 19,25
08143 0845	8 x 45	150	150	€ 19,25



## FASCETTE NYLON PER CABLAGGIO BIANCHE

CODICE	DESCRIZIONE	CF	M.V.	PREZZO
08166 1435	140 x 3,5	100	100	€ 2,98
08166 2036	200 x 3,6	100	100	€ 4,06
08166 2548	250 x 4,8	100	100	€ 7,24
08166 3648	360 x 4,8	100	100	€ 9,99



## FASCETTE NYLON PER CABLAGGIO NERE

CODICE	DESCRIZIONE	CF	M.V.	PREZZO
08167 1325	130 x 2,5	100	100	€ 1,57
08167 2025	200 x 2,5	100	100	€ 2,77
08167 2935	290 x 3,5	100	100	€ 5,88
08167 4348	430 x 4,8	100	100	€ 9,99



# G4 - BANDELLA



## BANDELLA METALLICA

CODICE	DESCRIZIONE	CF	M.V.	PREZZO
08170 1700	mm 17 x mm 10	10	1	€ 15,35

- Dispenser in plastica.



## CHIODI PER BANDELLA

CODICE	DESCRIZIONE	CF	M.V.	PREZZO
08174 2200	4 x 18	200	200	€ 18,00

- Prezzo riferito alla confezione da 200 pezzi.



**New**

## PERCUSSORE MANUALE PER CHIODI

CODICE	DESCRIZIONE	CF	M.V.	PREZZO
08177 0000	--	1	1	€ 70,00

## GRIGLIA TONDA DA INCASSO IN PP BIANCO PESANTE

CODICE	DESCRIZIONE	CF	M.V.	PREZZO
07190 0080	DM 80	1	1	€ 0,70
07190 0100	DM 100	1	1	€ 1,10
07190 0125	DM 125	1	1	€ 1,20
07190 0140	DM 140	1	1	€ 1,50
07190 0160	DM 160	1	1	€ 1,80
07190 0200	DM 200	1	1	€ 4,40



**New**

## GRIGLIA QUADRA E RETTANGOLARE DA SOVRAPPORRE IN PP BIANCO

CODICE	DESCRIZIONE	CF	M.V.	PREZZO
07192 2323	230 x 230	60	1	€ 3,60
07192 5023	500 x 230	35	1	€ 7,60



**New**

## SCHIUMA POLIURETANICA

CODICE	DESCRIZIONE	CF	M.V.	PREZZO
07221 0750	ml 750	12	1	€ 8,65



**SODAL**

## TASSELLO CHIMICO

CODICE	DESCRIZIONE	CF	M.V.	PREZZO
07222 0000	300 ml	12	1	€ 12,80





## ADESIVO PASTOSO RIEMPITIVO

CODICE	DESCRIZIONE	CF	M.V.	PREZZO
07216 0125	tubetto da 125 gr. rosso	10	1	€ 5,80
07216 0700	barattolo da 700 gr. rosso	10	1	€ 27,66



## TANGIT

CODICE	DESCRIZIONE	CF	M.V.	PREZZO
07218 0125	tangit 125 gr.	12	1	€ 17,23



## NEOGIT HP (TIPO TANGIT)

CODICE	DESCRIZIONE	CF	M.V.	PREZZO
07219 0125	gr. 125	12	1	€ 9,00

- Colla speciale per tubi e componenti in PVC rigido anche in pressione o per tubi di scarico.



**New**

## MUFFYXID - PULISCI MUFFA

CODICE	DESCRIZIONE	CF	M.V.	PREZZO
07225 0000	500 ml	12	1	€ 11,40

- Efficace e potente
- Agisce in 3-5 minuti
- Pulisce lo sporco di muffa, muschi, alghe e licheni
- Igienizza e ne ritarda la ricomparsa

## SBLOKKA

CODICE	DESCRIZIONE	CF	M.V.	PREZZO
07226 0000	400 ml	12	1	€ 8,25

- Spray sbloccante, lubrificante, istantaneo.



## ELASTUK

CODICE	DESCRIZIONE	CF	M.V.	PREZZO
07224 0000	8x15x490 mm x 4 file	16	1	€ 10,60

- Assicura perfetta tenuta tra vetro, metallo, legno e materie plastiche.



## EPOSTIK

CODICE	DESCRIZIONE	CF	M.V.	PREZZO
07227 0000	gr. 50	15	1	€ 9,30

- Mastice epossidico bicomponente in unico pezzo; ripara perdite anche sott'acqua, piscina, serbatoi. Ripara metalli, plastica, legno, ecc.



## AQUAKIT

CODICE	DESCRIZIONE	CF	M.V.	PREZZO
07212 0000	57 G	1	1	€ 22,80

- Ferma la perdita senza smontare, anche in presenza di bagnato e sott'acqua, in soli 15 minuti. Ottimo per riparare superfici danneggiate, anche in condizioni estreme. Utilizzabile con metallo, ceramica, legno, vetro e materie plastiche.

**New**





# SOUDAL

**IL GRUPPO SOUDAL  
COSTRUISCE IL FUTURO**

**Il Gruppo Soudal** è il più grande produttore europeo indipendente di sigillanti, adesivi e schiume poliuretaniche per utenti professionali e privati. Azienda player internazionale ed esperta in prodotti chimici per l'edilizia.

**Il Gruppo Soudal** produce prodotti per i propri marchi e per private label che coprono 7 famiglie: siliconi e altri sigillanti, schiume poliuretaniche, adesivi, polimeri ibridi, aerosol tecnici e prodotti chimici per l'edilizia. Con i propri marchi il **Gruppo Soudal** si focalizza su 3 segmenti di mercato: i settori edile, industriale e retail.



**Incollaggio**



**Sigillatura dei giunti**



**Riempimento**



**Isolamento**



**Sigillatura**



**Ancoraggio**

## SILICONE ACETICO

CODICE	DESCRIZIONE	CF	M.V.	PREZZO
07230 0100	Bianco 280 ml	24	1	€ 4,37
07230 0200	Trasparente 280 ml	24	1	€ 4,37

- Resistente ai raggi UV
- Permanente elastico dopo l'applicazione
- Per applicazioni interne ed esterne
- Idoneo su vetro, metallo, ceramica, alluminio, legno verniciato
- Non indicato su materiali sintetici, pietre naturali, metalli delicati o che contengono rame



**SODAL**

## SILICONE PER SANITARI BAGNI E CUCINE STOP MUFFA

CODICE	DESCRIZIONE	CF	M.V.	PREZZO
07232 0100	Bianco 300 ml	12	1	€ 7,25
07232 0200	Trasparente 300 ml	12	1	€ 7,25

- Non annerisce, insensibile alla muffa.
- Ottimo per applicazioni in bagni, cucine, box doccia ed ambienti con forte presenza di umidità.
- 10 anni di garanzia.



**SODAL**

## SILICONE ACRILICO FESSURE E MURI

CODICE	DESCRIZIONE	CF	M.V.	PREZZO
07234 0100	Bianco 300 ml	24	1	€ 3,20

- Verniciabile
- Ottimo su materiali da costruzione e per sigillare crepe su muri o sull'intonaco



**SODAL**

## SILICONE ALTE TEMPERATURE

CODICE	DESCRIZIONE	CF	M.V.	PREZZO
07237 0001	Nero ml 310	12	1	€ 12,30



**SODAL**

## G5 - ADESIVI E SIGILLANTI



### SIGILLANTE REFRAATTARIO KAMIN

CODICE	DESCRIZIONE	CF	M.V.	PREZZO
07236 0000	Nero 500 gr	12	1	€ 8,69

- Sigilla anche parti esposte alla fiamma diretta.



### SILICON

CODICE	DESCRIZIONE	CF	M.V.	PREZZO
07247 0150	gr. 150	40	1	€ 3,75



### PASTA VERDE ANTIGRIPPANTE

CODICE	DESCRIZIONE	CF	M.V.	PREZZO
07248 0450	gr. 450	24	1	€ 3,95

### CANAPA PETTINATA IN BUSTA

CODICE	DESCRIZIONE	CF	M.V.	PREZZO
07249 0000	gr. 250	40	1	€ 9,30

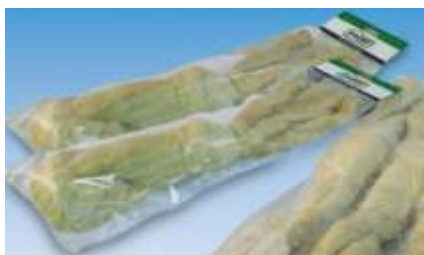

## CANAPA PETTINATA

CODICE	DESCRIZIONE	CF	M.V.	PREZZO
07250 0000	gr 250	1	1	€ 8,60



## TEFLON A FILO LOCTITE 55

CODICE	DESCRIZIONE	CF	M.V.	PREZZO
07257 0000	mt 160	48	1	€ 33,50

- Nastro in multifibra di nylon, utilizzabile per sigillare qualsiasi raccordo fino a 6", in plastica e metallo.
- Idoneo per acqua potabile, secondo DM 174/2004.
- Non indurisce.
- Sostituisce completamente canapa, pasta e nastri sigillanti.
- Temperatura di esercizio -55° a +130° C.



## TEFLON PROFESSIONALE GAS

CODICE	DESCRIZIONE	CF	M.V.	PREZZO
07252 1212	12 mm x 12 mt	150	10	€ 0,55
07252 1519	15 x 3/4 - 19	25	5	€ 2,08



## GAS SEAL

CODICE	DESCRIZIONE	CF	M.V.	PREZZO
07253 0000	100 gr	24	1	€ 16,25

- Prodotto anaerobico con elevata resistenza meccanica; per gas; GPL; metano; idrocarburi; olii; nafta.



**New**



**FAREN**

## F200 ANTICALCARE PER CASSETTE

CODICE	DESCRIZIONE	CF	M.V.	PREZZO
07229 0000	1 lt	12	1	€ 11,25

- Disincrostante a base di acidi sicuri e concentrati, specifico per la pulizia anticalcare delle cassette wc. Risolve completamente il problema delle incrostazioni che inceppano la cassetta wc.
- Agisce in pochi minuti.
- Non intacca guarnizioni, gomme e plastiche.



**FAREN**

## MELT DISGORGANTE

CODICE	DESCRIZIONE	CF	M.V.	PREZZO
07259 0000	750 ml	12	1	€ 7,90



**FACOT**

## DISINEX VIRAGGIO

CODICE	DESCRIZIONE	CF	M.V.	PREZZO
07255 0500	lt 5	4	1	€ 23,00

- Disincrostante a base acida, idoneo per trattare scambiatori in acciaio, rame e ghisa (NO per alluminio e superfici zincate).



**FACOT**

## ZINCONEX - LQ

CODICE	DESCRIZIONE	CF	M.V.	PREZZO
07256 0500	lt 5	4	1	€ 29,95

- Disincrostante concentrato, non corrosivo, ideale per trattare scambiatori di caldaie a condensazione e pompe di calore.



## THERMAKIL 2X STRONG

CODICE	DESCRIZIONE	CF	M.V.	PREZZO
07238 0050	lt 0,5	16	1	€ 14,60
07238 0300	lt 3	4	1	€ 49,00

**SUPER CONCENTRATO lt 0,5 STRONG THERMAKIL = lt 1 THERMAKIL CLASSICO**

- Algicida ad ampio spettro, ideale per rimuovere impurità da impianti a pavimento, impianti di riscaldamento e raffrescamento.



## ANTINEX 2X STRONG - SCIOGLIFANGHI PER IMPIANTI TERMICI

CODICE	DESCRIZIONE	CF	M.V.	PREZZO
07241 0050	lt 0,5	16	1	€ 15,00
07241 0300	lt 3	4	1	€ 56,00

**SUPER CONCENTRATO lt 0,5 STRONG ANTINEX = lt 1 ANTINEX CLASSICO**

- Sciogli fanghi ad alta concentrazione, per tutti i tipi di impianti termici; svolge anche azione risanante.



## FILMAX 2X STRONG

CODICE	DESCRIZIONE	CF	M.V.	PREZZO
07243 0050	lt 0,5	16	1	€ 25,00
07243 0300	lt 3	4	1	€ 107,00

**SUPER CONCENTRATO lt 0,5 STRONG FILMAX = lt 1 FILMAX CLASSICO**

- Svolge una funzione protettiva come inibitore di corrosione; idoneo sia per impianti termici classici, che per impianti a pavimento.



## THERMO CLEAN 750 ml CON EROGATORE

CODICE	DESCRIZIONE	CF	M.V.	PREZZO
07244 0000	Disincrostante	12	1	€ 38,30

- Ideale per pulire le camere di combustione delle caldaie a condensazione





## THERMO SAN 750 ml CON EROGATORE

CODICE	DESCRIZIONE	CF	M.V.	PREZZO
07246 0000	Sanificante	12	1	€ 35,50

- Protettivo, da usare dopo il trattamento con THERMO CLEAN



## ALIGEL HC30 BIO - ad alta concentrazione

CODICE	DESCRIZIONE	CF	M.V.	PREZZO
09539 0000	lt 5	4	1	€ 51,13

- Fluido termovettore anticongelante, anticorrosivo a base di glicole monopropilenico biodegradabile. Prestazioni elevate, resistente da -32° a +160°C (5 bar), con rilevatore di perdite fluorescente.



## GLICOLE PURO ALIGEL

CODICE	DESCRIZIONE	CF	M.V.	PREZZO
09538 0000	5 lt.	4	1	€ 64,50

- Puro, da diluire.



## POLIFLUID

CODICE	DESCRIZIONE	CF	M.V.	PREZZO
09380 0010	lt 10	1	1	€ 41,50

- Additivo superfluidificante per massetti, specifico per pavimenti radianti.



## IGIENIZZANTE SPRAY PER CONDIZIONATORE

CODICE	DESCRIZIONE	CF	M.V.	PREZZO
07268 0000	400 ml	12	1	€ 11,25



## KLIMA FOAM

CODICE	DESCRIZIONE	CF	M.V.	PREZZO
07273 0000	400 ml	12	1	€ 9,88



## CLIMAFAST TUBI MANUALE

CODICE	DESCRIZIONE	CF	M.V.	PREZZO
07270 0000	ml 800	12	1	€ 30,00

- È la soluzione più semplice e veloce per lavare piccole linee di un impianto di condizionamento. Non è necessario utilizzare altre attrezzature; premendo direttamente il cono di gomma in dotazione della bomboletta.



## FUGAS ACC

CODICE	DESCRIZIONE	CF	M.V.	PREZZO
07274 0000	ml 400	12	1	€ 10,00

- Cercafughe schiumoso per la rilevazione di fughe di gas e aria su impianti a bassa ed alta pressione.





## PISTOLA PER SILICONE BASIC

CODICE	DESCRIZIONE	CF	M.V.	PREZZO
07280 0000	--	12	1	€ 6,00



## PISTOLA PER SILICONE PROFESSIONALE

CODICE	DESCRIZIONE	CF	M.V.	PREZZO
07282 0000	--	12	1	€ 11,25



## ARCHETTO PROFESSIONALE

CODICE	DESCRIZIONE	CF	M.V.	PREZZO
07284 0000	304 mm	12	1	€ 6,00



## CUTTER IN ALLUMINIO

CODICE	DESCRIZIONE	CF	M.V.	PREZZO
07288 0000	lama 18 x 100 mm	12	1	€ 5,70



## SET 10 LAME PER CUTTER

CODICE	DESCRIZIONE	CF	M.V.	PREZZO
07289 0000	18 x 100 mm	20	1	€ 3,00

## POMPA DISINCROSTANTE MAXI 1.2

CODICE	DESCRIZIONE	RIF. F.	CF	M.V.	PREZZO
07301 0000	Prevalenza 12 mt Serbatoio 20 lt.	939890	1	1	€ 785,00

- Per rimuovere calcare da bollitori, caldaie e scambiatori.
- Facile da pulire e ideale per la decalcificazione di grandi impianti.
- Inversione di flusso.



**MGF**

## POMPA DISOSTRUENTE PUSH-UP

CODICE	DESCRIZIONE	RIF. F.	CF	M.V.	PREZZO
07312 0000	Aspira e spinge	904150	1	1	€ 254,00

- Per disotturare lavandini, bidet, scarichi in genere.
- 3 tamponi in dotazione per adattarsi a tutte le esigenze.



**MGF**

## POMPA DISOSTRUENTE MANUALE FULL OPTIONAL

CODICE	DESCRIZIONE	RIF. F.	CF	M.V.	PREZZO
07314 0000	260x120x570 mm; kg 8	904100	1	1	€ 347,08

- In dotazione tamponi DM 65, 100, 170 e spirale.
- Disostruisce scarichi da DM 21 a DM 170 mm.
- Può essere utilizzata per collaudi fino a 9,5 bar.
- Idonea al gonfiaggio di pneumatici.



**MGF**

## MDM 150

CODICE	DESCRIZIONE	RIF. F.	CF	M.V.	PREZZO
07316 0000	Ø tubo 20-150 mm	904199	1	1	€ 4.500,00

- Lunghezza max 30 mt.
- Inversione di rotazione.
- Dotazione: molle DM 8, 16 e 22 mm; 5 spirali e 3 lance.
- Leggera e maneggevole lavora in modo veloce e pulito.



**MGF**



## STURALAVELLO A MOLLA

CODICE	DESCRIZIONE	CF	M.V.	PREZZO
07318 0035	mt 3,5	1	1	€ 6,80
07318 0050	mt 5	1	1	€ 8,90

- Filo 1.30



## PISTOLA STURA SCARICHI AD ARIA COMPRESSA

CODICE	DESCRIZIONE	CF	M.V.	PREZZO
07319 0000	--	1	1	€ 45,50

- Uso semplicissimo.  
- Ideale per lavabo, bidet, vasca da bagno, doccia, wc, lavelli, ecc.  
- Completa di 4 adattatori in gomma.



## KIT CHIAVE ESAGONALE

CODICE	DESCRIZIONE	RIF. F.	CF	M.V.	PREZZO
07330 0000	9-10-11-12-13-14-17	920392	1	1	€ 76,80

- Asta cava cm 25 e testa snodata cm 12.

**MGF**



## KIT CHIAVE A SCALINO + CHIAVE A CRICCHETTO

CODICE	DESCRIZIONE	RIF. F.	CF	M.V.	PREZZO
07332 0000	Per codoli UNI	916000	1	1	€ 88,00

- In acciaio al cromo-vanadio, temperata e zincata

**MGF**

## PINZA REGOLABILE CLASSIC C/IMPUGNATURA

CODICE	DESCRIZIONE	RIF. F.	CF	M.V.	PREZZO
07340 0740	7"/180 mm - Ap. 1 - 1/4 /40 mm	920179	1	1	€ 50,50
07340 0850	10"/240 mm - Ap. 1 - 1/2 /50 mm	920178	1	1	€ 52,50
07340 0965	12"/300 mm - Ap. 2 - 1/2 /65 mm	920177	1	1	€ 93,50



**MGF**

## GIRATUBI AMERICANO

CODICE	DESCRIZIONE	RIF. F.	CF	M.V.	PREZZO
07342 1190	24"/609 mm - Ap. 3"/90 mm	920496	1	1	€ 164,06

- In lega di alluminio rinforzato, ganascia in acciaio speciale CR-MO temperato.



**MGF**

## GIRATUBI SVEDEVE 90°

CODICE	DESCRIZIONE	RIF. F.	CF	M.V.	PREZZO
07344 0635	12"/320 mm - Ap. 1"/35 mm	920699	1	1	€ 74,37
07344 0846	16"/420 mm - Ap. 1 - 1/2 /46 mm	920698	1	1	€ 112,30
07344 0965	20"/560 mm - Ap. 2"/65 mm	920697	1	1	€ 145,69

- Blocco rullino.  
- Con protezione anti-schiacciamento.  
- Dentatura asimmetrica.



**MGF**

## GIRATUBI SVEDEVE 45° C/INCAVO

CODICE	DESCRIZIONE	RIF. F.	CF	M.V.	PREZZO
07346 0635	12"/320 mm - Ap. 1"/35 mm	920598	1	1	€ 49,43
07346 0846	16"/420 mm - Ap. 1 - 1/2 /46 mm	920597	1	1	€ 70,73
07346 0965	20"/560 mm - Ap. 2"/65 mm	920596	1	1	€ 115,94

- Blocco rullino.  
- Con protezione anti-schiacciamento.  
- Dentatura asimmetrica.



**MGF**



## PINZA REGOLABILE AUTOBLOCCANTE A CATENA

CODICE	DESCRIZIONE	RIF . F	CF	M.V.	PREZZO
07336 0000	Catena diametro 150 Lunghezza 482 mm	922451	1	1	€ 58,19

- Lunghezza pinza 240 mm



## CHIAVE PER PILETTE

CODICE	DESCRIZIONE	CF	M.V.	PREZZO
07334 0000	Lunghezza 160 mm	1	1	€ 72,77



## CHIAVE PER PILETTE NORTON

CODICE	DESCRIZIONE	CF	M.V.	PREZZO
07335 0000	1"; 1-1/4	1	1	€ 47,00



## CHIAVE A RULLINO

CODICE	DESCRIZIONE	CF	M.V.	PREZZO
07338 0200	200 mm	12	1	€ 10,00
07338 0250	250 mm	6	1	€ 15,00



## CURVATUBI CM 22

CODICE	DESCRIZIONE	RIF. F.	CF	M.V.	PREZZO
07350 1022	10-12-14-16-18-20-22 mm	902300	1	1	€ 445,96

- Per tubi rame e multistrato con e senza rivestimento.



## MOLLE CURVATUBI

CODICE	DESCRIZIONE	CF	M.V.	PREZZO
07352 0012	Diametro 12	1	1	€ 17,15
07352 0014	Diametro 14	1	1	€ 19,85
07352 0016	Diametro 16	1	1	€ 25,31
07352 0020	Diametro 20	1	1	€ 30,87
07352 0026	Diametro 26	1	1	€ 40,43

- Per tubo multistrato e rame;  
la misura fa riferimento al diametro interno del tubo.



## CESOIA CLASSIC 35

CODICE	DESCRIZIONE	CF	M.V.	PREZZO
07366 0000	Economica	1	1	€ 16,59

- \* Funzionamento a cricco  
- Lama intercambiabile  
- Apertura manuale



## CESOIA PER TUBI DI PLASTICA

CODICE	DESCRIZIONE	CF	M.V.	PREZZO
07368 0000	Ø 75	1	1	€ 172,50

- Per tubi PE, PE-X, PP fino a Ø 75 mm.  
- Funzionamento a cricco.





## SBAVATORE INTERNI/ESTERNI

CODICE	DESCRIZIONE	RIF. F.	CF	M.V.	PREZZO
07370 0000	40 mm	922999	1	1	€ 33,00

- Per tubi rame, alluminio, plastica e multistrato



## CALIBRATORE - SBAVATORE - SMUSSATORE

CODICE	DESCRIZIONE	CF	M.V.	PREZZO
07372 0000	16x2; 20x2; 26x3; 32x3	1	1	€ 87,36

- In acciaio temperato  
- Ricalibra e sbava all'interno del tubo multistrato



## CALIBRATORE SVASATORE CON LAME IN ACCIAIO

CODICE	DESCRIZIONE	CF	M.V.	PREZZO
07373 0000	Ø 16 - 20 - 26	1	1	€ 13,95



## CALIBRATORE IN PLASTICA

CODICE	DESCRIZIONE	CF	M.V.	PREZZO
07374 0000	Da 14 a 32 mm	1	1	€ 9,49

## PRESSATRICE A BATTERIA MINI 32

CODICE	DESCRIZIONE	RIF. F.	CF	M.V.	PREZZO
07380 0000	Fino a 32 mm, completa di ganasce	900988	1	1	€ 3.840,00

- N. 02 Batterie incluse
- Pressa i raccordi in soli 4 secondi
- Segnalazioni a led
- Pesa soltanto 1,6 kg, ruota a 360°
- Inserti optional



**MGF**

## GANASCE TH

CODICE	DESCRIZIONE	CF	M.V.	PREZZO
07381 0026	Diametro 26	1	1	€ 261,04
07381 0020	Diametro 20	1	1	€ 261,04

- Tipo ganasce: Comap - Sudopress - Dalpex - Giacomini - Giacoflex  
Giacoterm - Henco - Tiemme - Cobrapress.
- In acciaio speciale di altissima qualità.
- Sono compatibili con macchine di altre marche.



**MGF**

## PRESSATRICE MANUALE

CODICE	DESCRIZIONE	RIF. F.	CF	M.V.	PREZZO
07382 0000	MGF	900970	1	1	€ 686,18

- Con inserti TH 16, 20 e 26



**MGF**

## KIT SALDATURA OSSIACETILENICA (OSSIGENO + MAP GAS)

CODICE	DESCRIZIONE	CF	M.V.	PREZZO
07384 0000	DM 16-20-26	1	1	€ 341,25

- Completa di inserti
- Profilo TH



# G11 - ATTREZZATURA IDRAULICA PER RAME



## TAGLIATUBI MINI

CODICE	DESCRIZIONE	CF	M.V.	PREZZO
07360 0322	3 - 22 mm	1	1	€ 29,89
07360 0328	3 - 28 mm	1	1	€ 43,60

- Per rame.

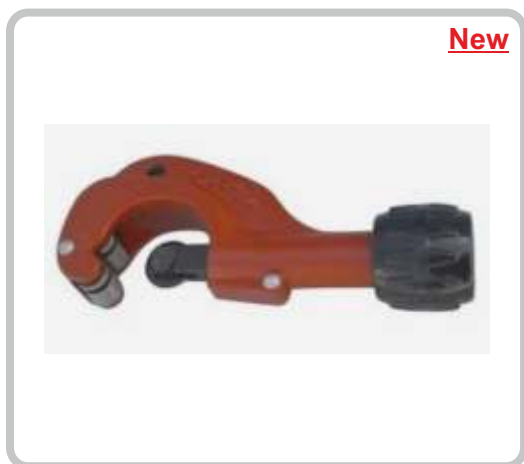

**New**

## TAGLIATUBI A RULLO

CODICE	DESCRIZIONE	CF	M.V.	PREZZO
07363 0335	Ø 3 - 35	10	1	€ 25,00

- Per tubi in rame.



## ESPANSORE PER TUBI IN RAME

CODICE	DESCRIZIONE	CF	M.V.	PREZZO
07378 1022	Ø 10-22	1	1	€ 65,00



## KIT SALDATURA OSSIACETILENICA (OSSIGENO + MAP GAS)

CODICE	DESCRIZIONE	RIF . F	CF	M.V.	PREZZO
07390 0000	T° fiamma > 3100°C	938087	1	1	€ 315,00

- 2,5 Volte più conveniente dei sistemi standard
- Cannello con protezione anti-ritorno a 2 punte

## POMPA VUOTO BISTADIO

CODICE	DESCRIZIONE	RIF. F.	CF	M.V.	PREZZO
07802 0042	42 l/min	930456	1	1	€ 396,00
07802 0085	85 l/min	930457	1	1	€ 612,00

- Con elettrovalvola e vacuometro
- Attacco 1/4 SAE



## TERMOMETRO DIGITALE

CODICE	DESCRIZIONE	RIF. F.	CF	M.V.	PREZZO
07812 0000	con cavo 1 mt	932398	1	1	€ 61,95

- Campo temperatura -55 °C/300 °C
- Funzioni: massimo, minimo e hold



## KIT GRUPPO MANOMETRICO

CODICE	DESCRIZIONE	RIF. F.	CF	M.V.	PREZZO
07824 0000	4 vie R410A, R32	930792	1	1	€ 197,40

- Manometro diametro 80



## FOGGY - NEBULIZZATORE AD ULTRASUONI

CODICE	DESCRIZIONE	CF	M.V.	PREZZO
07830 0100	Foggy + Alfaclean 500 ml	1	1	€ 1.309,35
07830 0200	Alfaclean 500 ml	1	1	€ 34,65

- Da utilizzare nelle condotte di aerazione e negli scambiatori.
- Il disinfettante certificato Alfaclean è efficace su tutti i batteri che popolano le unità di trattamento aria, con un'esposizione di soli 2 minuti.





**TEFLON**



**SIGILLANTI**



**PRODOTTI CHIMICI**



**ATTREZZATURE DISOSTRUENTE**



**TUBI E RACCORDI PPS GRIGIO**

# RAME

## CLIMATIZZAZIONE

*Se non mi trovi subito non scoraggiarti,  
se non mi trovi in un posto cerca in un altro,  
da qualche parte starò fermo ad aspettarti.*

*Walt Whitman*





# TUBO E RACCORDI RAME



# TRATTAMENTO ARIA



# CONDIZIONAMENTO

## SANCO - TUBI IN VERGHE DA 5 METRI

CODICE	DESCRIZIONE	MT	M.V.	PREZZO
07500 1200	12 x 1	5	5	€ 12,97
07500 1400	14 x 1	5	5	€ 15,80
07500 1600	16 x 1	5	5	€ 19,30
07500 1800	18 x 1	5	5	€ 21,43
07500 2200	22 x 1	5	5	€ 24,80
07500 2800	28 x 1	5	5	€ 34,12

- Prezzo riferito al metro.



## TUBO RAME RIVESTITO "373"

CODICE	DESCRIZIONE	MT	M.V.	PREZZO
07502 1001	10 x 1	50	50	€ 14,46
07502 1201	12 x 1	50	50	€ 15,51
07502 1401	14 x 1	50	50	€ 17,15
07502 1601	16 x 1	50	50	€ 22,32
07502 1801	18 x 1	50	50	€ 23,87
07502 2201	22 x 1	25	25	€ 31,35



## TUBO RAME RIVESTITO PER GAS

CODICE	DESCRIZIONE	MT	M.V.	PREZZO
07504 1201	12 x 1	50	50	€ 15,79
07504 1401	14 x 1	50	50	€ 19,30
07504 1801	18 x 1	50	50	€ 26,66
07504 2201	22 x 1	25	25	€ 53,63



## TUBO SPIRALATO AUTOESTINGUENTE PER RIVESTIMENTI TUBI GAS

CODICE	DESCRIZIONE	MT	M.V.	PREZZO
07406 0020	Diametro 20	50	50	€ 1,80
07406 0025	Diametro 25	25	25	€ 2,45
07406 0030	Diametro 30	25	25	€ 2,63
07406 0035	Diametro 35	25	25	€ 5,00





## TUBO ISOLANTE POLAR SPESSORE 6 mm/mt 2

CODICE	DESCRIZIONE	CF	M.V.	PREZZO
07400 0622	22 (interno 23,5 - 25), 1/2	97	1	€ 3,88
07400 0627	27 (interno 28,5 - 30), 3/4	70	1	€ 4,81
07400 0634	34 (interno 35,5 - 37), 1"	55	1	€ 5,60
07400 0642	42 (interno 45 - 47), 1 - 1/4	40	1	€ 6,59

- Prezzo riferito a barra da 2 mt.



## TUBO ISOLANTE CELLULE CHIUSE SPESSORE 9 mm/mt 2

CODICE	DESCRIZIONE	CF	M.V.	PREZZO
07402 1022	22 (interno 23,5 - 25), 1/2	1	1	€ 3,56
07402 1028	28 (interno 29 - 31), 3/4	1	1	€ 3,18
07402 1035	35 (interno 36 - 37,5), 1"	1	1	€ 3,78
07402 1042	42 (interno 45 - 47), 1 - 1/4	1	1	€ 4,62
07402 1048	48 (interno 51 - 53), 1 - 1/2	1	1	€ 5,07
07402 1060	60 (interno 63 - 65), 2"	1	1	€ 6,35
07402 1088	88 (interno 92 - 95), 3"	1	1	€ 10,96

- Prezzo riferito a barra da 2 mt.



**New**

## TUBO ISOLANTE CELLULE CHIUSE SPESSORE 13 MM FIT2

CODICE	DESCRIZIONE	CF	M.V.	PREZZO
07403 0035	35 (interno 36-37,5), 1"	1	1	€ 4,69
07403 0042	42 (interno 45-47), 1-1/4	1	1	€ 5,43
07403 0048	48 (interno 51-53), 1-1/2	1	1	€ 6,20
07403 0054	54 (interno 55-58)	1	1	€ 7,30
07403 0064	64 (interno 63-65), 2"	1	1	€ 8,80
07403 0075	76 (interno 76-79), 2"1/2	1	1	€ 10,35
07403 0088	89 (interno 92-95), 3"	1	1	€ 12,63

- Prezzo riferito al tubo da 2 mt.



## NASTRO ISOLANTE ANTICONDENZA ADESIVO NERO

CODICE	DESCRIZIONE	CF	M.V.	PREZZO
07404 0000	mt 10	24	1	10,23

- Spessore 3 mm.



# H3 - RACCORDI A STRINGERE PER RAME

## MANICOTTO RAME PER ACQUA - GAS - IDROCARBURI

CODICE	DESCRIZIONE	CF	M.V.	PREZZO
07510 1010	10	10	1	€ 5,07
07510 1212	12	10	1	€ 6,41
07510 1414	14	10	1	€ 6,86
07510 1616	16	10	1	€ 6,90
07510 1818	18	10	1	€ 7,84
07510 2222	22	10	1	€ 12,71
07510 2828	28	10	1	€ 19,38



**GIACOMINI**  
WATER E-MOTION

## GIUNTO DRITTO MASCHIO RAME PER ACQUA - GAS - IDROCARBURI

CODICE	DESCRIZIONE	CF	M.V.	PREZZO
07512 1004	½ x 10	10	1	€ 3,30
07512 1204	½ x 12	10	1	€ 3,65
07512 1404	½ x 14	10	1	€ 3,80
07512 1604	½ x 16	10	1	€ 4,00
07512 1804	½ x 18	10	1	€ 4,95
07512 1805	¾ x 18	10	1	€ 5,30
07512 2205	¾ x 22	10	1	€ 8,49
07512 2806	1" x 28	10	1	€ 11,50



**GIACOMINI**  
WATER E-MOTION

## GIUNTO DRITTO FEMMINA RAME PER ACQUA - GAS - IDROCARBURI

CODICE	DESCRIZIONE	CF	M.V.	PREZZO
07514 1004	½ x 10	10	1	€ 3,28
07514 1204	½ x 12	10	1	€ 3,59
07514 1404	½ x 14	10	1	€ 3,94
07514 1604	½ x 16	10	1	€ 4,55
07514 1804	½ x 18	10	1	€ 5,52
07514 1805	¾ x 18	10	1	€ 5,64
07514 2205	¾ x 22	10	1	€ 9,75
07514 2806	1" x 28	10	1	€ 11,45



**GIACOMINI**  
WATER E-MOTION

# H3 - RACCORDI A STRINGERE PER RAME



## GOMITO RAME PER ACQUA - GAS - IDROCARBURI

CODICE	DESCRIZIONE	CF	M.V.	PREZZO
07520 1010	10	10	1	€ 5,44
07520 1212	12	10	1	€ 6,53
07520 1414	14	10	1	€ 7,47
07520 1616	16	10	1	€ 8,82
07520 1818	18	10	1	€ 11,21
07520 2222	22	10	1	€ 17,47
07520 2828	28	10	1	€ 24,44



## GOMITO MASCHIO RAME PER ACQUA - GAS - IDROCARBURI

CODICE	DESCRIZIONE	CF	M.V.	PREZZO
07522 1004	½ X 10	10	1	€ 5,05
07522 1204	½ X 12	10	1	€ 5,11
07522 1404	½ X 14	10	1	€ 5,89
07522 1604	½ X 16	10	1	€ 6,97
07522 1804	½ X 18	10	1	€ 8,69
07522 1805	¾ X 18	10	1	€ 8,94
07522 2205	¾ X 22	10	1	€ 13,99
07522 2806	1" X 28	10	1	€ 30,52



## GOMITO FEMMINA RAME PER ACQUA - GAS - IDROCARBURI

CODICE	DESCRIZIONE	CF	M.V.	PREZZO
07523 1004	½ X 10	10	1	€ 4,95
07523 1204	½ X 12	10	1	€ 5,08
07523 1404	½ X 14	10	1	€ 5,80
07523 1604	½ X 16	10	1	€ 6,64
07523 1804	½ X 18	10	1	€ 8,28
07523 1805	¾ X 18	10	1	€ 8,51
07523 2205	¾ X 22	10	1	€ 13,34
07523 2806	1" X 28	10	1	€ 22,61



## GOMITO FEMMINA C/STAFFA RAME PER ACQUA - GAS - IDROCARBURI

CODICE	DESCRIZIONE	CF	M.V.	PREZZO
07526 1204	½ X 12	10	1	€ 7,98
07526 1404	½ X 14	10	1	€ 8,01
07526 1604	½ X 16	10	1	€ 8,57

# H3 - RACCORDI A STRINGERE PER RAME

## TES RAME PER ACQUA - GAS - IDROCARBURI

CODICE	DESCRIZIONE	CF	M.V.	PREZZO
07550 0010	10	10	1	€ 7,72
07550 0012	12	10	1	€ 8,44
07550 0014	14	10	1	€ 10,20
07550 0016	16	10	1	€ 11,68
07550 0018	18	10	1	€ 14,96
07550 0022	22	10	1	€ 23,89
07550 0028	28	10	1	€ 34,90



 **GIACOMINI**  
WATER E-MOTION

## TES FEMMINA RAME PER ACQUA - GAS - IDROCARBURI

CODICE	DESCRIZIONE	CF	M.V.	PREZZO
07551 1204	1/2 X 12	50	1	€ 7,75
07551 1404	1/2 X 14	50	1	€ 8,97
07551 1604	1/2 X 16	50	1	€ 13,23
07551 1805	3/4 X 18	50	1	€ 16,18
07551 2205	3/4 X 22	50	1	€ 23,56
07551 2806	1" X 28	50	1	€ 38,08



 **GIACOMINI**  
WATER E-MOTION

# H4 - RACCORDI PER CONDIZIONAMENTO



## DADO PER RACCORDI CONDIZIONAMENTO

CODICE	DESCRIZIONE	CF	M.V.	PREZZO
07610 0200	1/4 ø 6	10	1	€ 1,32
07610 0300	3/8 ø 10	10	1	€ 2,26
07610 0400	1/2 ø 12	10	1	€ 2,74
07610 1600	5/8 ø 16	10	1	€ 4,20



## RACCORDO DOPPIO PER CONDIZIONAMENTO

CODICE	DESCRIZIONE	CF	M.V.	PREZZO
07630 0202	1/4 x 1/4 ø 6	10	1	€ 1,76
07630 0303	3/8 x 3/8 ø 10	10	1	€ 3,06
07630 0404	1/2 x 1/2 ø 12	10	1	€ 4,71
07630 1616	5/8 x 5/8 ø 16	10	1	€ 8,93



## RACCORDO DOPPIO RIDOTTO PER CONDIZIONAMENTO

CODICE	DESCRIZIONE	CF	M.V.	PREZZO
07632 0203	Ridotto 1/4 x 3/8	10	1	€ 4,76
07632 0204	Ridotto 1/4 x 1/2	10	1	€ 5,78
07632 0216	Ridotto 1/4 x 5/8	10	1	€ 7,83
07632 0304	Ridotto 3/8 x 1/2	10	1	€ 7,14
07632 0316	Ridotto 3/8 x 5/8	10	1	€ 7,83
07632 0416	Ridotto 1/2 x 5/8	10	1	€ 7,83



## GOMITO DOPPIO PER CONDIZIONAMENTO

CODICE	DESCRIZIONE	CF	M.V.	PREZZO
07620 0202	1/4	10	1	€ 3,57
07620 0303	3/8	10	1	€ 6,09
07620 0404	1/2	10	1	€ 8,60
07620 1616	5/8	10	1	€ 10,19

## CURVE DI INVERSIONE

CODICE	DESCRIZIONE	CF	M.V.	PREZZO
07646 0200	1/4 SAE	1	1	€ 13,50
07646 0300	3/8 SAE	1	1	€ 22,00



## MANICOTTO GIUNZIONE AUTOCARTELLANTE

CODICE	DESCRIZIONE	CF	M.V.	PREZZO
07648 0200	1/4	1	1	€ 39,00
07648 0300	3/8	1	1	€ 54,50
07648 0400	1/2	1	1	€ 69,50



## ADATTATORE PER 410A

CODICE	DESCRIZIONE	CF	M.V.	PREZZO
07644 0000	1/4 "SAE Mx5/16" SAE F	1	1	€ 12,30



## RIDUZIONE PER BOMBOLA (R32)

CODICE	DESCRIZIONE	CF	M.V.	PREZZO
07634 0220	1/4 SAE x M20	1	1	€ 14,30
07634 0320	3/8 SAE x M20	1	1	€ 14,30



# H4 - RACCORDI PER CONDIZIONAMENTO



## RUBINETTO PER BOMBOLA R32 KG1

CODICE	DESCRIZIONE	CF	M.V.	PREZZO
07638 0000	--	1	1	€ 35,70



## VALVOLA PER FRUSTA-CLIMA-VUOTO

CODICE	DESCRIZIONE	CF	M.V.	PREZZO
07640 0000	«1/4 SAE F c/girello x 1/4" SAE M	1	1	€ 22,80



## VALVOLA M-M

CODICE	DESCRIZIONE	CF	M.V.	PREZZO
07641 0000	1/4 "SAE Mx1/4" SAE M	1	1	€ 22,80

## FRUSTA PER CONDIZIONAMENTO 5/16F x 5/16F

CODICE	DESCRIZIONE	CF	M.V.	PREZZO
07804 0100	Rossa (recuperat. - bombola GAS)	1	1	€ 49,50
07804 0200	Blu (condizion. - vacuometro)	1	1	€ 49,50

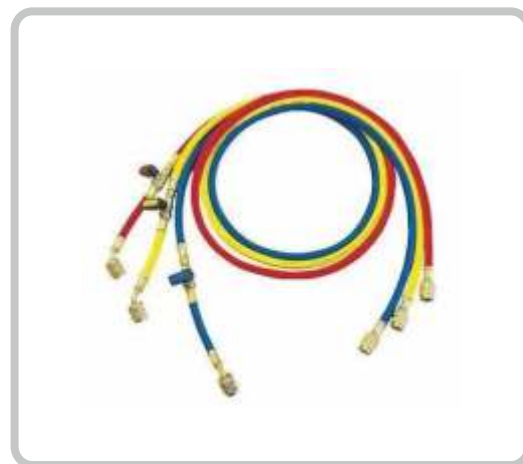

## FRUSTA PER CONDIZIONAMENTO 1/4F x 5/16F

CODICE	DESCRIZIONE	CF	M.V.	PREZZO
07806 0300	Gialla (1/4 pompa vuoto - 5/16 vacuometro)	1	1	€ 49,50



## GAS REFRIGERANTE KG 1

CODICE	DESCRIZIONE	CF	M.V.	PREZZO
08042 0407	R 407	1	6	€ 122,50
08042 0410	R 410	1	6	€ 131,90
08042 0422	R 422	1	6	€ 147,50
08042 0032	R 32	1	6	€ 80,00





## NASTRO ALLUMINIO ADESIVO

CODICE	DESCRIZIONE	CF	M.V.	PREZZO
07408 5050	H 50 mm x 50 mm	12	1	€ 14,17



## BENDA BIANCA

CODICE	DESCRIZIONE	CF	M.V.	PREZZO
07410 1025	cm 10 x mt 25	1	1	€ 9,72



## TUBO RAME CONDIZIONAMENTO

CODICE	DESCRIZIONE	MT	M.V.	PREZZO
07506 0200	1/4" (6,35 x 1,0)	50	50	€ 7,34
07506 0300	3/8" (9,52 x 1,0)	50	50	€ 10,85
07506 0400	1/2" (12,70 x 1,0)	50	50	€ 14,38
07506 0450	5/8" (15,87 x 1,0)	50	50	€ 17,50
07506 0500	3/4" (19,05 x 1,0)	25	25	€ 23,88

- Prezzo riferito al metro.



## TUBO RAME CONDIZIONAMENTO

CODICE	DESCRIZIONE	MT	M.V.	PREZZO
07508 0200	1/4" x 0,8	50	50	€ 6,05
07508 0300	3/8" x 0,8	50	50	€ 8,65
07508 0400	1/2" x 0,8	50	50	€ 11,47

- Prezzo riferito al metro.

## CASSETTA DI PREDISPOSIZIONE CONDIZIONAMENTO

CODICE	DESCRIZIONE	CF	M.V.	PREZZO
08002 0000	45x10x6	20	1	€ 11,28



## CASSETTA DI PREDISPOSIZIONE CONDIZIONAMENTO C/GALLEGGIANTE

CODICE	DESCRIZIONE	CF	M.V.	PREZZO
08003 0000	Genius box	1	1	€ 30,00



## KIT SIFONE A SECCO PER SCARICO CONDENSA

CODICE	DESCRIZIONE	CF	M.V.	PREZZO
08004 0000	15x17 Ispezionabile. BAMPI	15	1	€ 20,75

- Con sfera antiodore



## SIFONE A SECCO PER SCARICO CONDENSA

CODICE	DESCRIZIONE	CF	M.V.	PREZZO
08006 0000	Incasso	15	1	€ 15,50



# H8 - TUBO CONDENSA E ACCESSORI



## SIFONE SCARICO CONDENSA «WALLTRAP»

CODICE	DESCRIZIONE	CF	M.V.	PREZZO
08008 0000	Incasso o parete	1	1	€ 8,82

- Ø 16 - 18 - 20 - 32 - 1"



## GIUNTO A «Y» UNIVERSALE

CODICE	DESCRIZIONE	CF	M.V.	PREZZO
08010 0000	16/18/20	20	1	€ 3,30



## RACCORDO CONNESSIONE DA TUBO RIGIDO A TUBO SPIRALATO

CODICE	DESCRIZIONE	CF	M.V.	PREZZO
08009 0016	DM 16	20	1	€ 4,00
08009 0020	DM 20	20	1	€ 4,25



## TUBO PER CONDENSA

CODICE	DESCRIZIONE	MT	M.V.	PREZZO
08012 0016	Ø 16	30	30	€ 1,31
08012 0020	Ø 20	30	30	€ 1,75

## CANALE COPERCHIO - ML. 2

CODICE	DESCRIZIONE	CF	M.V.	PREZZO
08020 6045	60 x 45	12	1	€ 11,05
08020 8060	80 x 60	8	1	€ 14,81
08020 1175	110 x 75	4	1	€ 23,56

- Prezzo riferito ad asta da mt 2.



## CANALINA CONDIZIONAMENTO

CODICE	DESCRIZIONE	CF	M.V.	PREZZO
08022 3035	30 x 35	32	1	€ 7,17

- Prezzo riferito ad asta da mt 2.



## CURVA A MURO

CODICE	DESCRIZIONE	CF	M.V.	PREZZO
08030 6045	60 x 45	9	1	€ 4,59
08030 8060	80 x 60	6	1	€ 5,71
08030 1175	110 x 75	4	1	€ 8,32



## CURVA PIANA

CODICE	DESCRIZIONE	CF	M.V.	PREZZO
08032 6045	60 x 45	10	1	€ 3,63
08032 8060	80 x 60	8	1	€ 5,17
08032 1175	110 x 75	6	1	€ 7,15



# H9 - CANALINA PER CLIMA



## ANGOLO ESTERNO

CODICE	DESCRIZIONE	CF	M.V.	PREZZO
08034 6045	60 x 45	12	1	€ 4,04
08034 8060	80 x 60	9	1	€ 4,96



## ANGOLO INTERNO

CODICE	DESCRIZIONE	CF	M.V.	PREZZO
08036 6045	60 x 45	8	1	€ 4,04
08036 8060	80 x 60	6	1	€ 4,96
08036 1175	110 x 75	4	1	€ 6,35



## PASSAGGIO A MURO

CODICE	DESCRIZIONE	CF	M.V.	PREZZO
08040 6045	60 x 45	10	1	€ 4,04
08040 8060	80 x 60	8	1	€ 4,96



**New**

## GIUNTO PER CANALINA

CODICE	DESCRIZIONE	CF	M.V.	PREZZO
08043 6045	60 x 45	1	1	€ 2,99
08043 8060	80 x 60	1	1	€ 3,10
08043 1175	110 x 75	1	1	€ 4,09

## STAFFE PER CONDIZIONATORE

CODICE	DESCRIZIONE	CF	M.V.	PREZZO
08050 3541	350x410x800 ELEFANT	1	1	€ 22,70
08050 3548	350x480x800 ELEFANT	1	1	€ 24,41
08050 6060	600x600x1000 ELEFANT	1	1	€ 72,50



## STAFFE PER CONDIZIONATORE A TETTO

CODICE	DESCRIZIONE	CF	M.V.	PREZZO
08052 0000	480x350x800	1	1	€ 71,76

- Inclinabile



## BASE A TERRA PER CONDIZIONATORE

CODICE	DESCRIZIONE	CF	M.V.	PREZZO
08056 0035	cm 35	12	1	€ 13,00
08056 0045	cm 45	12	1	€ 15,75
08056 1045	cm 45 H10	12	1	€ 17,65

- Prezzo riferito a coppia



## KIT ANTIVIBRANTE

CODICE	DESCRIZIONE	CF	M.V.	PREZZO
08058 0000	pz. 4 - kg 50	1	1	€ 27,50



## SUPPORTO A PAVIMENTO IN GOMMA

CODICE	DESCRIZIONE	CF	M.V.	PREZZO
08059 0040	kg 250 x 2 - L400 - L160 x 95H	1	1	€ 54,50
08059 0060	kg 400 x 2 - L400 - L160 x 95H	1	1	€ 70,00

- Il prezzo è riferito alla coppia.





## ASPIRATORE DA MURO

CODICE	DESCRIZIONE	RIF. F.	CF	M.V.	PREZZO
08312 0000	Ø 100 - 15w - mc/h90	11123	1	1	€ 95,20

- LxPxH 7,7x15,9x15,9 cm



## ASPIRATORE DA MURO ELICOCENTRICO

CODICE	DESCRIZIONE	RIF. F.	CF	M.V.	PREZZO
08313 0100	Ø 100 9W MC/H90	11313	1	1	€ 147,81
08313 0120	Ø 120 13 W MC/H175	11333	1	1	€ 176,23

- Idoneo per scarico diretto o canalizzato fino a 5 mt.  
- Centrifugo



## ASPIRATORE DA MURO/VETRO 230/9" AR LL S

CODICE	DESCRIZIONE	RIF. F.	CF	M.V.	PREZZO
08316 0230	700 mc/h 35w	12455	1	1	€ 349,00
08316 0100	comando 5 velocità		1	1	€ 103,00

- Aspiratore elicoidale reversibile (solo abbinato al comando).  
- Chiusura automatica griglia.



## ASPIRATORE FILO-MURO 230/9" ARI LL S

CODICE	DESCRIZIONE	RIF. F.	CF	M.V.	PREZZO
08318 0230	680 mc/h 35w	12456	1	1	€ 473,00
08316 0100	comando 5 velocità		1	1	€ 103,00

- Aspiratore elicoidale reversibile da incasso.  
- Chiusura automatica griglia.



## RECUPERATORE DI CALORE DECENTRALIZZATO VORT HRW 30 MONO EVO HCS

CODICE	DESCRIZIONE	RIF. F.	CF	M.V.	PREZZO
08320 0100	Tubazione Ø 100	12436	1	1	€ 805,00
08320 0160	Tubazione Ø 160	12437	1	1	€ 883,00

- Unità per VMC da singolo ambiente a flussi alternati con recuperatore di calore ad altissima efficienza (fino al 90%).
- 5 velocità impostabili: da 18 a 40 mc/h
- Telecomando.
- Sensore di umidità relativa a bordo macchina.
- Installazione a parete min. 260 mm - max 700 mm.
- Bus comunicazione per sincronizzare più apparecchi.



## TUBO PVC PER VMC HRW

CODICE	DESCRIZIONE	CF	M.V.	PREZZO
08322 0100	dm* 100 x cm 70	1	1	€ 26,00
08322 0160	dm* 160 x cm 70	1	1	€ 54,00

- \* diametro interno.



## BARRIERA D'ARIA

CODICE	DESCRIZIONE	RIF. F.	CF	M.V.	PREZZO
08340 0090	cm 90	65195	1	1	€ 425,00
08340 0120	cm 120	65196	1	1	€ 549,50
08340 0150	cm 150	65197	1	1	€ 691,80
08340 0200	cm 200	65198	1	1	€ 939,50

- Con telecomando.
- Aspirazione frontale: ti permette di montarla anche a filo tetto. Max 4 mt.



## PRODUTTORE DI OZONO

CODICE	DESCRIZIONE	CF	M.V.	PREZZO
07832 0000	--	1	1	€ 341,25

- Adatto sia per sanificare un ambiente, sia per purificare frutta e verdura immersi in acqua, grazie all'utilizzo di un tubicino fornito in dotazione.





## GRIGLIA TONDA DA INCASSO IN PP BIANCO PESANTE

CODICE	DESCRIZIONE	CF	M.V.	PREZZO
07190 0080	DM 80	1	1	€ 0,70
07190 0100	DM 100	1	1	€ 1,10
07190 0125	DM 125	1	1	€ 1,20
07190 0140	DM 140	1	1	€ 1,50
07190 0160	DM 160	1	1	€ 1,80
07190 0200	DM 200	1	1	€ 4,40



## GRIGLIA QUADRA E RETTANGOLARE DA SOVRAPPORRE IN PP BIANCO

CODICE	DESCRIZIONE	CF	M.V.	PREZZO
07192 2323	230 x 230	60	1	€ 3,60
07192 5023	500 x 230	35	1	€ 7,60



## MINI POMPA PER CONDENSA NTH 10.1

CODICE	DESCRIZIONE	CF	M.V.	PREZZO
08048 0000	MM 91 x 33,5 x H 51	1	1	€ 140,25



## CLIMATIZZATORI Q-CONFORT IBLEO-R32

CODICE	DESCRIZIONE	CF	M.V.	PREZZO
08380 2500	9000	1	1	€ 612,11
08380 3500	12000	1	1	€ 660,56
08380 5200	18000	1	1	€ 1.288,65



## CHIAVETTA WI-FI MIDEA

CODICE	DESCRIZIONE	CF	M.V.	PREZZO
08370 0000	Midea	1	1	€ 47,50



## CHIAVETTA WI-FI IDEMA

CODICE	DESCRIZIONE	CF	M.V.	PREZZO
08372 0000	Idema	1	1	€ 47,50



## CHIAVETTA WI-FI DAIKIN

CODICE	DESCRIZIONE	CF	M.V.	PREZZO
08374 0000	Daikin	1	1	€ 125,00



## CHIAVETTA WI-FI UNICAL

CODICE	DESCRIZIONE	CF	M.V.	PREZZO
08376 0000	Unical	1	1	€ 47,50



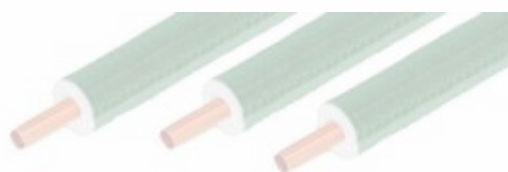

# TUBO E RACCORDI RAME



# TRATTAMENTO ARIA



# CONDIZIONAMENTO

# PRESSURIZZAZIONE E TRATTAMENTO ACQUE

*C'è una forza motrice più forte del vapore,  
dell'elettricità e dell'energia atomica:  
la volontà.*  
Albert Einstein



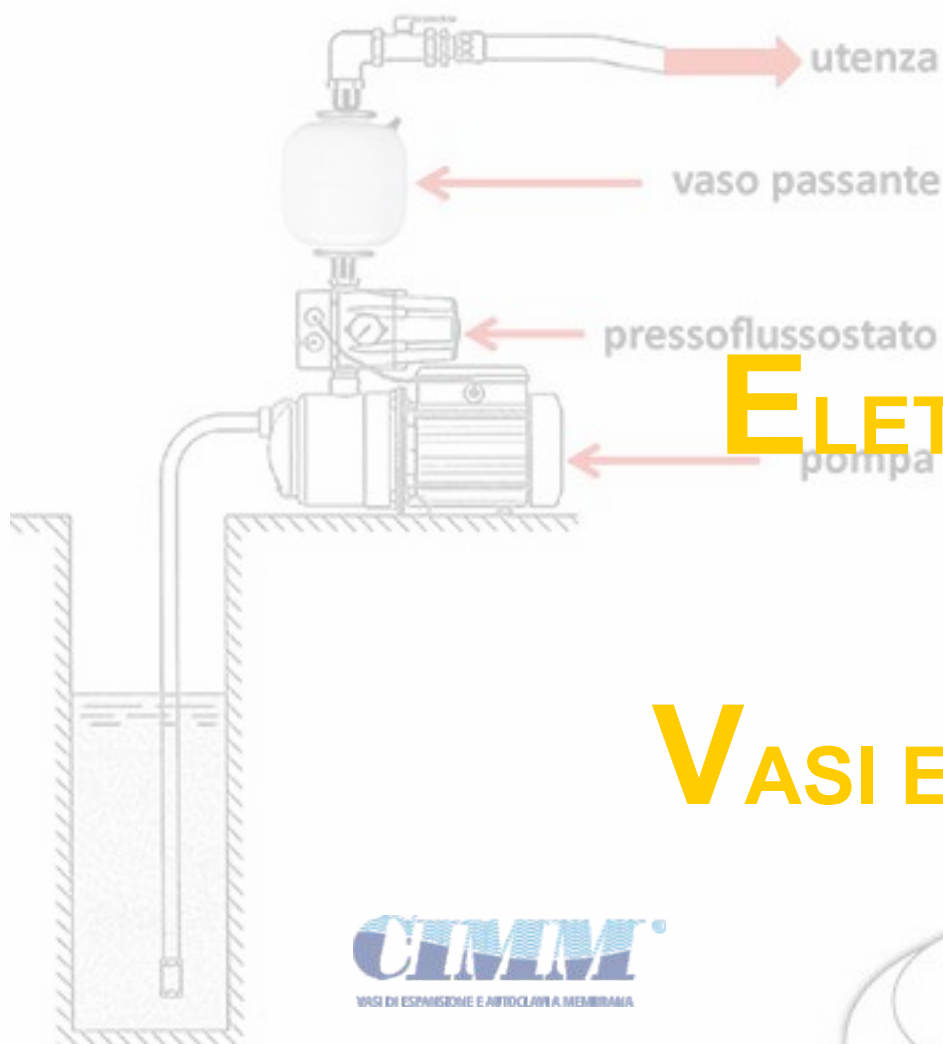

**ELETTROPOMPE**



**VASI ESPANSIONE**



**PRESSCONTROL**



**ADDOLCITORI**

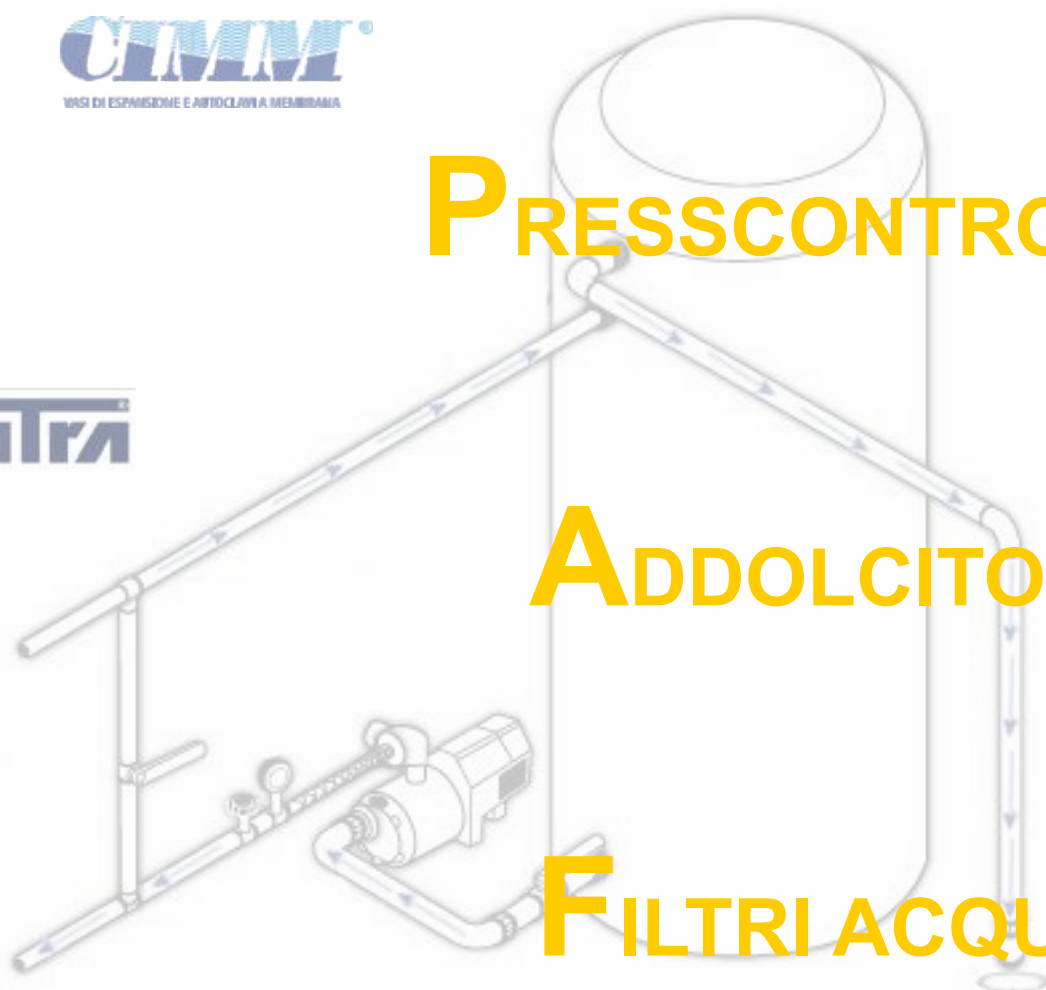

**FILTRI ACQUA**

## ELETTROPOMPE CON GIRANTE PERIFERICA

CODICE	TIPO	POTENZA		PRESTAZIONI		BOCCHIE		PREZZO
		KW	HP	Q	H	Asp.	Mand.	
08502 0000	Monofase Pkm60	0,37	0,50	5:40	38:5	1"	1"	Monofase € 142,44



## ELETTROPOMPE AUTOADESCANTI CON GIRANTE PERIFERICA

CODICE	TIPO	POTENZA		PRESTAZIONI		BOCCHIE		PREZZO
		KW	HP	Q	H	Asp.	Mand.	
08504 0060	Monofase PKSM60	0,37	0,50	5:40	38:5	1"	1"	Monofase € 200,51
08504 0065	PKSM65	0,55	0,75	5:50	50:6	1"	1"	€ 280,00
08504 0080	PKSM80	0,75	1	5:50	62:22	1"	1"	€ 380,00



## ELETTROPOMPE CENTRIFUGHE MULTIGIRANTI

CODICE	TIPO	POTENZA		PRESTAZIONI		BOCCHIE		PREZZO
		KW	HP	Q	H	Asp.	Mand.	
08506 2080	Monofase 2CPm80	0,37	0,50	5:70	26:5	1"	1"	Monofase € 281,58
08506 3080	3CPm80-C	0,45	0,60	5:80	38:5	1"	1"	€ 303,20
08506 4080	4CPm80-C	0,60	0,85	5:80	50:10	1"	1"	€ 334,30
08506 4100	4CPm100-C	0,75	1	5:130	50:5	1"	1"	€ 398,00



## ELETTROPOMPE CENTRIFUGHE

CODICE	TIPO	POTENZA		PRESTAZIONI		BOCCHIE		PREZZO
		KW	HP	Q	H	Asp.	Mand.	
08510 0130	Monofase CPM130	0,37	0,50	10:80	22:14	1"	1"	Monofase € 258,12
08510 0158	CPM158	0,75	1	10:90	34:25	1"	1"	€ 317,50
08510 0170	CPM170	1,1	1,5	30:160	30:19	1 1/4"	1"	€ 559,50



# 11 - ELETTROPOMPE PEDROLLO



## ELETTROPOMPE CENTRIFUGHE BIGIRANTI TURBO M

CODICE	TIPO	POTENZA		PRESTAZIONI		BOCCHIE		PREZZO
		KW	HP	Q	H	Asp.	Mand.	
08512 2514	TURBO M4B	1,1	1,5	20:100	52:22	1-1/4	1"	€ 753,50
08512 2516	TURBO M4A	1,5	2	20:140	56:30	1-1/4	1"	€ 865,00

- TURBO M4B: ex 2CPM25/14B
- TURBO M4A: ex 2CPM25/16B



## ELETTROPOMPE AUTOADESCANTI

CODICE	MODELLO	DESCRIZIONE						PREZZO
08520 0090	CKRM 90-E	0,75	1	5:50	49:13	1"	1"	€ 514,00

- Versione speciale con rasometro antibloccaggio



## ELETTROPOMPE AUTOADESCANTI JET

CODICE	MODELLO	DESCRIZIONE						PREZZO
08522 0102	Future Jet m1B	0.48	0.65	5-95	36-5.5	1"	1"	€ 300,40
08522 0101	Future Jet m1A	0.55	0.75	5-100	44-9	1"	1"	€ 300,40

- Girante in acciaio inox Aisi 304.



## ELETTROPOMPE AUTOADESCANTI JET

CODICE	MODELLO	DESCRIZIONE						PREZZO
08522 0203	Future Jet m2CX	0.75	1	5-120	52-10	1"	1"	€ 307,00
08522 0204	Future Jet m2AX	0.90	1.25	5-120	56-13,7	1"	1"	€ 381,50

- Girante in tecnopolimero.



## 12 - ELETTROPOMPE SOMMERSE PEDROLLO

### ELETTROPOMPE SOMMERSE CON GALLEGGIANTE

CODICE	MODELLO	DESCRIZIONE	PREZZO
08530 2200	UPM 2/2-GE	0,37 0,50 10:80 32:17 1-1/4	€ 700,00
08530 2300	UPM 2/3-GE	0,55 0,75 10:80 L6:23 1-1/4	€ 723,50
08530 2400	UPM 2/4-GE	0,75 1 10:80 61:31 1-1/4	€ 746,00
08530 4400	UPM 4/4-GE	0,75 1 20:120 52:16 1-1/4	€ 746,00
08530 2500	UPM 2/5-GE	1,1 1,5 10:80 79:40 1-1/4	€ 790,50

- Cavo alimentazione 20 MT



### ELETTROPOMPE SOMMERGIBILI VORTEX

CODICE	MODELLO	DESCRIZIONE	M.V.	PREZZO
08534 1035	VXM 10/35-N	HP 1 50:400 10:2 1-1/2	1	€ 588,00
08534 1535	VXM 15/35-N	HP 1,5 50:500 13,5:2 1-1/2	1	€ 790,00
08534 1550	VXM 15/50-N	HP 1,5 50:650 11:2 2"	1	€ 810,00



### ELETTROPOMPE SOMMERGIBILI TOP MULTI

CODICE	DESCRIZIONE	M.V.	PREZZO
08540 0100	TOP MULTI 1 - HP 0,5	1	€ 396,00
08540 0200	TOP MULTI 2 - Multigiranti - HP 0,75	1	€ 469,00
08540 0300	TOP MULTI 3 - Multigiranti - 0,75	1	€ 540,00



### ELETTROPOMPE SOMMERGIBILI TOP MULTI TECH

CODICE	DESCRIZIONE	M.V.	PREZZO
08542 0200	Presscontrol incorporato - HP 0,75 TECH 2	1	€ 581,30
08542 0400	Presscontrol incorporato - HP 1 TECH 4	1	€ 707,00

- Ripartenza impostata a 1,5 bar.
- Su richiesta possibilità di averla anche a 2,2 bar.
- Per il corretto funzionamento della pompa, è necessario installare la pompa con un vaso espansione tarato tra 1 e 1,2 bar.





**PEDROLLO**

## 4SR4 PUNTO DI MASSIMO RENDIMENTO 4m<sup>3</sup>/h

TIPO			POTENZA		PRESTAZIONI		BOCCHE	PREZZO
CODICE	TIPO	TIPO	kW	HP	Q	H	Mand.	Prezzo
08550 0220	4SR4m/8-PD	Monofase	0,75	1	20:100	60,2:22,5	1 1/4"	€ 748,50
08550 0380	4SR4/8-PD	Trifase	0,75	1	20:100	60,2:22,5	1 1/4"	€ 923,40



## 4SR6 PUNTO DI MASSIMO RENDIMENTO 6m<sup>3</sup>/h

TIPO			POTENZA		PRESTAZIONI		BOCCHE	PREZZO
CODICE	TIPO	TIPO	kW	HP	Q	H	Mand.	Prezzo
08552 0220	4SR6m/6-PD	Monofase	0,75	1	25:150	38:14,5	2"	€ 728,50
08552 0380	4SR6/6-PD	Trifase	0,75	1	25:150	38:14,5	2"	€ 903,30



## 4SR8 PUNTO DI MASSIMO RENDIMENTO 8m<sup>3</sup>/h

TIPO			POTENZA		PRESTAZIONI		BOCCHE	PREZZO
CODICE	TIPO	TIPO	kW	HP	Q	H	Mand.	Prezzo
08554 0220	4SR8m/7-PD	Monofase	1,1	1,5	40:200	47:14,5	2"	€ 780,24
08554 0380	4SR8/7-PD	Trifase	1,1	1,5	40:200	47:14,5	2"	€ 992,24



## 4SR10 PUNTO DI MASSIMO RENDIMENTO 10m<sup>3</sup>/h

TIPO			POTENZA		PRESTAZIONI		BOCCHE	PREZZO
CODICE	TIPO	TIPO	kW	HP	Q	H	Mand.	Prezzo
08556 0220	4SR10m/7-PD	Monofase	1,1	1,5	50:250	41,5:8,5	2"	€ 839,80
08556 0380	4SR10/7-PD	Trifase	1,1	1,5	50:250	41,5:8,5	2"	€ 1.014,40



## 4SR12 PUNTO DI MASSIMO RENDIMENTO 12m<sup>3</sup>/h

TIPO			POTENZA		PRESTAZIONI		BOCCHE	PREZZO
CODICE	TIPO	TIPO	kW	HP	Q	H	Mand.	Prezzo
08558 0220	4SR12m/9-PD	Monofase	1,5	2	50:300	47:11	2"	€ 988,63
08558 0380	4SR12/9-PD	Trifase	1,5	2	50:300	47:11	2"	€ 1.276,37



## CONDENSATORE CON ATTACCHI FASTON

CODICE	DESCRIZIONE	CF	M.V.	PREZZO
08580 1000	10 µF (∅ 30x70h)	1	1	€ 5,25
08580 1250	12,5 µF (∅ 36x68h)	1	1	€ 6,55
08580 1400	14 µF (∅ 36x68h)	1	1	€ 6,80
08580 2000	20 µF (∅ 40x70h)	1	1	€ 9,20
08580 2500	25 µF (∅ 45x70h)	1	1	€ 11,80
08580 3150	31,5 µF (∅ 45x92h)	1	1	€ 11,80

### COMPATIBILITÀ CON PRINCIPALI ELETTROPOMPE PEDROLLO

08580 1000: 2CPM80 - PKM60 - PKSM60

08580 1250: CPM130 - Futura Jet 1B - 3CPM80

08580 1400: 4CPM80 - Futura Jet 1A - PKM65 - CKRM90

08580 2000: 4CPM100 - CPM158 - PKM80/90 - PKSM80

08580 2500: Futura Jet 2C

08580 3150: 2CPM25/16 - CPM170



## CUSCINETTI PER ELETTROPOMPE

CODICE	DESCRIZIONE	RIF. F.	CF	M.V.	PREZZO
08582 6201	12x32x10mm	6201ZZ	10	1	€ 4,70
08582 6202	15x35x11mm	6202ZZC3	10	1	€ 7,10
08582 6203	17xx40x12mm	6203ZZ	10	1	€ 6,05
08582 6204	20x47x14mm	6204ZZC3E	10	1	€ 11,00

### COMPATIBILITÀ CON PRINCIPALI ELETTROPOMPE PEDROLLO

08582 6201: CPM130 - CK50 - PK60 - PKS60 - Futura Jet 1 - Top multi (pz 2)

08582 6202 + 08585 6201: 2CPM80 - 3CPM80 - 4CPM80 (pz 1+1)

08582 6203: 2CPM25 - 4CPM100 - CKR - CPM158 - Futura Jet 2 - PK80 (90) (pz 2)

08582 6204: CP160 - CP170



# I3 - RICAMBI PER ELETTROPOMPE PEDROLLO



## TENUTE MECCANICHE PER ELETTROPOMPE

CODICE	DESCRIZIONE	RIF. F.	CF	M.V.	PREZZO
08584 0012	Albero $\varnothing$ 12	AR-12	10	1	€ 8,65
08584 0013	Albero $\varnothing$ 13	AR-13	10	1	€ 8,65
08584 0014	Albero $\varnothing$ 14	AR-14	10	1	€ 8,65

### COMPATIBILITÀ CON PRINCIPALI ELETTROPOMPE

08584 0012: PKM60 - Futura Jet 1 - CPM130

08584 0013: 2CPM80 - 3CPM80 - 4CPM80 - 4CPM100

08584 0014: CPM158 - Futura Jet 2 - 2CPM25/130



## VENTOLE PER ELETTROPOMPE

CODICE	DESCRIZIONE	RIF. F.	CF	M.V.	PREZZO
08588 0063	101x21 mm	FAN-63	1	1	€ 4,70
08588 0071	114x20 mm	FAN-71	1	1	€ 6,00
08588 0080	126x26 mm	FAN-80	1	1	€ 8,40

### COMPATIBILITÀ CON PRINCIPALI ELETTROPOMPE

08588 0063: albero  $\varnothing$  12 x PK, JSW1, CPM130, 3CPM80, 4CPM80

08588 0071: albero  $\varnothing$  14,5 x JSW2, CP158, 4CPM100

08588 0080: albero  $\varnothing$  20 mm x 2CP, JSW3



## VALVOLA PER ELETTROPOMPE PKS

CODICE	DESCRIZIONE	CF	M.V.	PREZZO
08505 0000	--	1	1	€ 12,90



**MADE IN ITALY**

**Elettropompe di superficie, sommerse,  
sommersibili e motori**

# 14 - ELETTROPOMPE LOWARA



## ELETTROPOMPA SOMMERSA 5" SCUBA C/GALL.

CODICE	DESCRIZIONE	M.V.	PREZZO
08620 0505	3SC4/05/5G HP 0,75; Q: 20-70; P 40,8-17,8	1	€ 723,60
08620 0705	3SC5/07/5G HP 1; Q: 20-70; P 51,1-22	1	€ 784,00
08620 1105	3SC8/11/5G HP 1,5; Q: 20-70; P 75,6-29,3	1	€ 921,00



## ELETTROPOMPA SOMMERSA PER POZZI MONOBLOCCO

CODICE	DESCRIZIONE	M.V.	PREZZO
08622 0407	4GS07 HP 1 Parte idraulica	1	€ 306,00
08622 0411	4GS11 HP 1,5 Parte idraulica	1	€ 349,68
08624 0407	4OS07M HP 1 Motore monofase	1	€ 399,00
08624 0411	4OS11M HP 1,5 Motore monofase	1	€ 447,84



## PRESSCONTROL GENYO

CODICE	DESCRIZIONE	CF	M.V.	PREZZO
08804 1600	16A/R15-30	1	1	€ 148,60

- Adatto per pompe fino a 3 HP.

## ELETTROPOMPA CENTRIFUGA MULTISTADIO ORIZZONTALE

CODICE	DESCRIZIONE	M.V.	PREZZO
08603 0305	3HM03P05M HP 0,66 Q:20-70 P31,2-14,4	1	€ 339,50
08603 0405	3HM04P05M HP 0,75 Q: 20-70 P40,6-16,3	1	€ 365,80
08603 0506	3HM05P07M HP 1 Q: 20-70 P55,1-26,2	1	€ 463,50



## ELETTROPOMPA AUTODESCANTE GBGM7

CODICE	DESCRIZIONE	CF	M.V.	PREZZO
08604 0700	HP1	1	1	€ 329,00



## ELETTROPOMPA DI DRENAGGIO ACQUE CHIARE

CODICE	DESCRIZIONE	M.V.	PREZZO
08610 0000	DOC 3/A HP 0,33; Q: 50-135; P 5,6-2	1	€ 283,20



## ELETTROPOMPA DI DRENAGGIO ACQUE SPORCHE

CODICE	DESCRIZIONE	M.V.	PREZZO
08612 0000	DOMO 7 VX/B HP 0,75; Q: 100-260; P 6,6-2	1	€ 596,40



# 15 - ELETTROPOMPE X-POWER



## SMARTPUMP AUTODESCANTE

CODICE	DESCRIZIONE	CF	M.V.	PREZZO
08706 0500	HP 0,5 H 38	1	1	€ 256,25
08706 0750	HP 0,75 H 47	1	1	€ 307,50
08706 1000	HP 1 H 54	1	1	€ 349,40

- Con vaso espansione integrato da 1 lt.
- Protezione marcia a secco.
- Automatica.
- Testi periodico anti-bloccaggio.



## MIDIBOX - INVERTER SILENZIOSO

CODICE	DESCRIZIONE	CF	M.V.	PREZZO
08712 0000	250 - 750 watt H 40	1	1	€ 540,00
08712 0150	350 - 1500 watt H 52	1	1	€ 750,00

- Modulazione automatica della partenza in funzione della richiesta.
- Vaso espansione 200 ml integrato.
- Protezione marcia a secco.
- Auto-reset a tempo.



## EMAX - INVERTER

CODICE	DESCRIZIONE	RIF. F.	CF	M.V.	PREZZO
08714 0100	250 - 1000 watt - H 33	E-MAX 1	1	1	€ 513,00
08714 0200	250 - 1500 watt - H 47	E-MAX 2	1	1	€ 738,00

- Vaso espansione 400 ml integrato.
- Protezione marcia a secco.
- Auto-reset a tempo.
- Silenziosa.



## ELETTROPOMPA INVERTER AUTODESCANTE SILENZIOSA KOMODO

CODICE	DESCRIZIONE	CF	M.V.	PREZZO
08716 0008	Q 20,50,80 - H 38,24,8 - Watt 200+550	1	1	€ 475,00
08716 0010	Q 20,50,80 - H 45,30,15 - Watt 300+750	1	1	€ 545,00

- Protezione in caso di marcia a secco.
- Sistema di ripartenza automatica dopo la marcia a secco.
- Vaso espansione da 400 ml.
- Pressione di mantenimento regolabile.
- Spina e cavo elettrico in dotazione.



## ELETTROPOMPA CENTRIFUGA CON GIRANTE IN OTTONE

CODICE	MODELLO	DESCRIZIONE	CF	M.V.	PREZZO
08740 0000	CM6/2N	HP 0,5 H 36	1	1	€ 75,00



## ELETTROPOMPA AUTODESCANTE JET C

CODICE	DESCRIZIONE	CF	M.V.	PREZZO
08700 0075	HP 0,75 H 36	1	1	€ 160,00
08700 0100	HP 1 H 40	1	1	€ 175,00

- Autodescante fino a 8 mt



## ELETTROPOMPA MULTISTADIO SILEN-S

CODICE	DESCRIZIONE	RIF. F.	CF	M.V.	PREZZO
08702 0003	HP 0,50 H 32	SILEN - S3	1	1	€ 220,00
08702 0004	HP 0,75 H 42	SILEN - S4	1	1	€ 240,00
08702 0005	HP 1,00 H 52	SILEN - S5	1	1	€ 285,00

- Autodescante fino a 2 mt.  
- Silenziosa.



## ELETTROPOMPA MULTISTADIO SILENZIOSA SILEN-X

CODICE	DESCRIZIONE	CF	M.V.	PREZZO
08703 0120	HP 1,5 Q: 50,90,120 H: 50,38,25	1	1	€ 528,00
08703 0250	HP 2 Q:100, 180, 250 H: 43, 35 25	1	1	€ 695,00

- Girante in acciaio inox.  
- Termoprotettore incorporato.  
- Silenziosa.  
- 08703 0120 bocca 1", 08703 0250 bocca 1-1/2.





## MINIBOX - INVERTER - SILENZIOSO

CODICE	DESCRIZIONE	CF	M.V.	PREZZO
08720 0400	½ 2,8 bar	1	1	€ 325,00

- Ideale sia per aumentare la pressione idrica dell'impianto; sia per essere utilizzato come circolatore sanitario; con l'aggiunta del kit trasduttore lavora a pressione costante.



## CIRCOLATORE MINI-PUMP 120

CODICE	DESCRIZIONE	CF	M.V.	PREZZO
08722 0000	Int. 180	1	1	€ 245,00

- Ideale per aumentare la pressione dell'acqua di 1,2 bar.
- Stop per marcia a secco.
- Flussostato incorporato.
- All'apertura del rubinetto, la pompa parte e alla chiusura del rubinetto, la pompa si ferma.



## SUBTRONIC AUTOMATICA

CODICE	DESCRIZIONE	CF	M.V.	PREZZO
08730 0080	HP 0,80 H 36	1	1	€ 550,00
08730 0100	HP 1 H 50	1	1	€ 625,00

- Presscontrol incorporato
- Supporto di mandata in tecnopolimero
- Assenza di scaldature e punti deboli nell'involucro esterno



## PRESSOSTATO RICAMBIO PER SMART PUMP

CODICE	DESCRIZIONE	CF	M.V.	PREZZO
08705 0500	Smart pump 500 vecchio modello	1	1	€ 25,00
08705 0750	Smart pump 750 vecchio modello	1	1	€ 25,00
08705 1000	Smart pump 100 vecchio modello	1	1	€ 25,00
08705 2500	Smart pump 500 TIME	1	1	€ 25,00
08705 2750	Smart pump 750 TIME	1	1	€ 25,00
08705 2100	Smart pump 1000 TIME	1	1	€ 25,00



## FLUSSOSTATO RICAMBIO PER SMART PUMP

CODICE	DESCRIZIONE	CF	M.V.	PREZZO
08707 0001	Smart pump vecchio modello	1	1	€ 33,00
08707 0002	Smart pump TIME	1	1	€ 33,00



## VASETTO ESPANSIONE A BORDO MACCHINA

CODICE	DESCRIZIONE	CF	M.V.	PREZZO
08709 0800	1/2 800 gr	1	1	€ 36,00
08709 0400	3/8 400 gr	1	1	€ 36,00

- 800 gr x smart pump vecchio modello e nuovo.
- 400 gr per Komodo, mini box e vario smart.



## KIT TRASDUTTORE

CODICE	DESCRIZIONE	CF	M.V.	PREZZO
08720 0500	kit trasduttore	1	1	€ 76,28

- Accoppiato al MINI-BOX diventa un sistema automatico per l'aumento della pressione idrica in modalità costante.
- Max assortimento 250 W.



# 17 - ELETTROPOMPE SOMMERSE X-POWER



## ELETTROPOMPA SOMMERSA MULTISTADIO STAR 4GQ

CODICE	DESCRIZIONE	CF	M.V.	PREZZO
08630 0750	HP 0,75; Q: 20-40-90; P 35-32-19	1	1	€ 390,00

- Raffreddamento a liquido.
- Completa di galleggiante, quadro elettrico e 10 mt. di cavo.
- Giranti in PPO.
- Acqua con contenuto di sabbia non superiore a 30g/mc.



**New**

## ELETTROPOMPA SOMMERSA MONOBLOCCO MAX 4 SLIM

CODICE	DESCRIZIONE	CF	M.V.	PREZZO
08731 0075	HP 0,75; H 45	1	1	€ 360,00
08731 0100	HP 1; H 63	1	1	€ 445,00

- Particolarmente resistente alle correnti galvaniche
- Con galleggiante
- In dotazione 10 metri di cavo elettrico
- Condensatore all'interno della pompa
- Assenza di saldature e punti deboli nell'involucro esterno



**New**

## ELETTROPOMPA SOMMERSA MONOBLOCCO MAX 5

CODICE	DESCRIZIONE	CF	M.V.	PREZZO
08731 0150	HP 1,5; H 80	1	1	€ 626,00

- Particolarmente resistente alle correnti galvaniche
- Con galleggiante
- In dotazione 10 metri di cavo elettrico
- Il condensatore è all'interno del quadro avviatore
- Assenza di saldature e punti deboli nell'involucro esterno

# 17 - ELETTROPOMPE SOMMERSE X-POWER

## ELETTROPOMPA SOMMERSA 4" MAX4-2XP COMPLETA DI QUADRO ELETTRICO

CODICE	DESCRIZIONE	CF	M.V.	PREZZO
08733 0100	HP1 - Q 20,40,75 - H 92,75,16	1	1	€ 542,00
08733 0150	HP1,5 - Q 20,40,75 - H 133,107,23	1	1	€ 613,00
08733 0200	HP2 - Q 20,40,75 - H 173,138,28	1	1	€ 695,00

- Ideale per pozzi con sabbia, fino a max 400 gr/mc.
- Giranti e diffusori in PPOM caricato con fibra di vetro.
- Quadro elettrico completo di interruttore luminoso stagno, salvamotore, condensatore e spina shuko.
- Mandata 1"-1/4



## ELETTROPOMPA SOMMERSA 4" MAX 4-4XP- COMPLETA DI QUADRO ELETTRICO

CODICE	DESCRIZIONE	CF	M.V.	PREZZO
08734 0100	HP 1 Q. 20,70,100 H 74,46,14	1	1	€ 486,50
08734 0150	HP 1,5 Q. 20,70,100 H 104,62,21	1	1	€ 552,50
08734 0200	HP 2 Q. 20,70,100 H 133,85,29	1	1	€ 618,50

- Ideali per pozzi con sabbia fino a max 400 gr/m3.
- Giranti e diffusori in PPOM caricato con fibra di vetro.
- Quadro elettrico completo di interruttore luminoso stagno, salvamotore, condensatore e spina shuko.
- Mandata 1"-1/4



## ELETTROPOMPA SOMMERSA 4" MAX4-6XP COMPLETA DI QUADRO ELETTRICO

CODICE	DESCRIZIONE	CF	M.V.	PREZZO
08735 0100	HP1 - Q 20,80,100 - H 48,35,12	1	1	€ 453,00
08735 0150	HP1,5 - Q 20,80,100 - H 68,52,20	1	1	€ 503,00
08735 0200	HP2 - Q 20,80,100 - H 92,70,25	1	1	€ 579,00

- Ideale per pozzi con sabbia, fino a max 400 gr/mc.
- Giranti e diffusori in PPOM caricato con fibra di vetro.
- Quadro elettrico completo di interruttore luminoso stagno, salvamotore, condensatore e spina shuko.
- Mandata 1"-1/4



## PIRANHA - ELETTROPOMPA SOMMERSA PER ACQUE SPORCHE

CODICE	DESCRIZIONE	CF	M.V.	PREZZO
08738 0100	HP 1 H 14	1	1	€ 671,00
08738 0150	HP 1,5 H 16	1	1	€ 737,00
08738 0200	HP 2 H 23	1	1	€ 790,00

- Con galleggiante elettrico
- 8 mt di cavo
- Elevata capacità di triturazione
- Ideale per acque fognarie di civili abitazioni



# 18 - ACCESSORI PER ELETTROPOMPE SOMMERSE



## QUADRO ELETTRICO PER POMPE SOMMERSE

CODICE	DESCRIZIONE	CF	M.V.	PREZZO
08736 0100	Hp1 - 9A - 25µF	1	1	€ 47,00
08736 0150	HP1,5 - 12A - 35µF	1	1	€ 48,00
08736 0200	HP2 - 15A - 45µF	1	1	€ 52,00

- Alimentazione monofase 230V.
- Interruttore start-stop.
- Fornito con cavo di alimentazione e spina shuko.



## BARILOTTO REGGIPOMPA

CODICE	DESCRIZIONE	CF	M.V.	PREZZO
08737 0600	1" cm 20	1	1	€ 18,00
08737 0700	1-1/4 cm 20	1	1	€ 27,00
08737 0800	1-1/2 cm 20	1	1	€ 33,00
08737 0900	2" cm 20	1	1	€ 42,00

- In acciaio inox 316, per aggrappaggio pompa sommersa.



## PROTEZIONE CATODICA PER POMPE SOMMERSE

CODICE	DESCRIZIONE	CF	M.V.	PREZZO
08739 0700	1-1/4"	1	1	€ 87,00
08739 0900	2"	1	1	€ 106,50

- Realizzato in lega di ghisa e zinco; attira a sé le correnti galvaniche.
- Da avvitare sulla mandata della pompa.



## COPERCHIO PER POZZI

CODICE	DESCRIZIONE	CF	M.V.	PREZZO
08741 0000	DM 250 x 40 MM	1	1	€ 170,00
08741 0050	DM 250 x 50 MM	1	1	€ 185,00
08741 0063	DM 250 x 63 MM	1	1	€ 195,00



## ELETTROPOMPA SOMMERSA MPT ACQUE CHIARE E SCURE

CODICE	DESCRIZIONE	CF	M.V.	PREZZO
08743 0400	Watt 400 - H 5,5 mt - Q 6 mc h	1	1	€ 111,50
08743 0550	Watt 550 - H 7 mt - Q 8 mc h	1	1	€ 125,00
08743 0900	Watt 900 - H 8,5 mt - Q 12 mc h	1	1	€ 137,00

- Uscita 1"-1/2.
- Passaggio solido max 25 mm.



## ELETTROPOMPA SOMMERSA MSS ACQUE CHIARE E SCURE

CODICE	DESCRIZIONE	CF	M.V.	PREZZO
08745 0550	Watt 400 - H 7 mt - Q 8 mc h	1	1	€ 193,20
08745 0900	Watt 900 - H 9 mt - Q 10 mc h	1	1	€ 205,00

- Uscita 1"-1/2.
- Passaggio solido max 25 mm.



## ELETTROPOMPA PER PISCINA CON PREFILTRO

CODICE	MODELLO	DESCRIZIONE	CF	M.V.	PREZZO
08750 0100	PPB 100M	HP 1 monofase	1	1	€ 437,50
08750 0150	PPB 150M	HP 1.5 monofase	1	1	€ 700,00
08750 3150	PPB 150T	HP 1.5 trifase	1	1	€ 600,00
08750 0200	PPB 200M	HP 2 monofase	1	1	€ 740,00
08750 3200	PPB 200T	HP 2 trifase	1	1	€ 687,50
08750 3300	PPB 300T	HP 3 trifase	1	1	€ 725,00

\* Adatte anche per acqua salata



## TUBO SEMIRIGIDO AD INCOLLAGGIO PER PISCINA

CODICE	DESCRIZIONE	CF	M.V.	PREZZO
08752 0000	DM 50	50	50	€ 9,00





## RACCORDO PLASTICA 3PZ

CODICE	DESCRIZIONE	CF	M.V.	PREZZO
08851 0000	1"	50	1	€ 4,00

- Completo di guarnizione piana ed OR.



## PRESSCONTROL MATRA 3 REGOLABILE CON MANOMETRO

CODICE	DESCRIZIONE	CF	M.V.	PREZZO
08800 1530	0,5 - 4 bar.	12	1	€ 43,75

- Regolatore di pressione per elettropompe



## MATRACONTROL SMART-AUTOMATICO

CODICE	DESCRIZIONE	CF	M.V.	PREZZO
08802 0000	Fino a 3 HP	12	1	€ 46,75

- Regolazione automatica pressione di partenza.
- Installazione verticale/orizzontale.
- Ripartenza automatica in caso di mancanza di acqua.
- Scheda resinata IP67.
- Completo di manometro.



## INVERTER PER ELETTROPOMPE MONOFASE

CODICE	DESCRIZIONE	CF	M.V.	PREZZO
08820 0100	Fino a 1 HP 1"	1	1	€ 305,00
08820 0200	Fino a 2 HP 1-1/4"	1	1	€ 439,00

- Modula i giri dell'elettropompa, ottenendo risparmio energetico e pressione costante.
- Evita i colpi d'ariete.
- Regolazione intuitiva.
- Protezione marcia a secco.
- Completo di cavi elettrici.
- Il modello XP4700 riesce a gestire anche una 2° pompa.



## PRESSCONTROL PLUTO CON MANOMETRO

CODICE	DESCRIZIONE	CF	M.V.	PREZZO
08812 1500	1,5 bar	12	1	€ 43,75
08812 2200	2,2 bar	12	1	€ 43,75

- Protezione marcia a secco.



## SCHEDA PER PRESSCONTROL PLUTO CON MANOMETRO

CODICE	DESCRIZIONE	CF	M.V.	PREZZO
08814 1500	Scheda 1,5 bar	1	1	€ 27,75
08814 2200	Scheda 2,2 bar	1	1	€ 27,75

- Protezione marcia a secco.



## MASCONTROL

CODICE	DESCRIZIONE	CF	M.V.	PREZZO
08836 0000	1-1/4	10	1	€ 189,00

- Ideale dove necessita un passaggio d'acqua maggiore  
 - Può essere montato su pompe di superficie e su pompe sommerse, fino a 3 HP



## CONTROLPRES 3 PHASE UP

CODICE	DESCRIZIONE	CF	M.V.	PREZZO
08837 0000	1-1/4	10	1	€ 462,50

- Alimentazione trifase 400 VAC  
 - Può essere montato su pompe di superficie e su pompe sommerse fino a 3 HP  
 - Protezione contro l'inverione del senso di rotazione del motore  
 - Protezione contro la mancanza di una fase in alimentazione





## AUTOCLAVE PRESSCONTROL WATERTECH

CODICE	DESCRIZIONE	CF	M.V.	PREZZO
08830 1500	Bar. 1,5	10	1	€ 93,05
08830 2200	Bar. 2,2	10	1	€ 93,05
08830 3000	Bar. 3,0	10	1	€ 93,05

- Autoclave presscontrol
- Regolatore di pressione
- Per elettropompe



## SCHEDA ELETTRONICA PER PRESSCONTROL WATERTECH

CODICE	DESCRIZIONE	CF	M.V.	PREZZO
08832 0000		1	1	€ 57,50

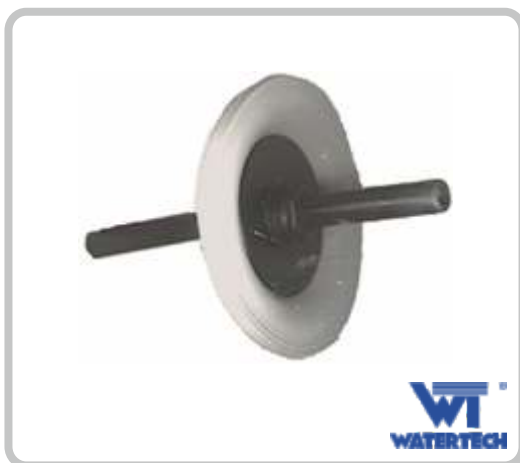

## MEMBRANA PER AUTOCLAVE PRESSCONTROL

CODICE	DESCRIZIONE	CF	M.V.	PREZZO
08834 1500	Press. bar. 1,5	1	1	€ 25,00
08834 2200	Press. bar. 2,2	1	1	€ 25,00



## PRESSOFLUSSOSTATO UP WATERTECH

CODICE	DESCRIZIONE	CF	M.V.	PREZZO
08838 0000	1"	1	1	€ 73,50



## ALIMENTATORE AUTOMATICO D'ARIA TIPO 1

CODICE	DESCRIZIONE	CF	M.V.	PREZZO
08840 0100	Per serbatoi da litri 24 a 500	1	1	€ 62,30
08840 0200	Per serbatoi da litri 750 a 2000	1	1	€ 101,70



## SFIATO PER ALIMENTATORE ARIA

CODICE	DESCRIZIONE	CF	M.V.	PREZZO
08841 0000	--	1	1	€ 10,90



## FLESSIBILE PER SERBATOIO

CODICE	DESCRIZIONE	CF	M.V.	PREZZO
08842 0070	F 1/2 x 1/2 M cm 70	1	1	€ 11,10
08842 0100	F 3/4 x 1/2 M cm 100	1	1	€ 21,20



## SERBATOIO ZINCATO SENZA COLLAUDO

CODICE	DESCRIZIONE	M.V.	M.V.	PREZZO
08843 0100	LT 100	1	1	€ 391,00





## NIPPLES FORATO

CODICE	DESCRIZIONE	CF	M.V.	PREZZO
08844 0603	1" x 1/4 M	1	1	€ 7,96



## NIPPLES FORATO

CODICE	DESCRIZIONE	CF	M.V.	PREZZO
08845 0603	1" x 1/4 F	1	1	€ 7,96



## ATTACCO A 5 VIE

CODICE	DESCRIZIONE	CF	M.V.	PREZZO
08850 0000	1" Alto	1	1	€ 12,50



## PRESSOSTATO SQUARE D

CODICE	DESCRIZIONE	CF	M.V.	PREZZO
08846 1446	FSG2 1,4 - 4,6	25	1	€ 25,00
08846 2870	FY22 2,8 - 7,0 (bar)	1	1	€ 42,89



## PRESSOSTATO CON GIRELLO

CODICE	DESCRIZIONE	CF	M.V.	PREZZO
08848 0000	2 - 4,2 bar	25	1	€ 10,50



## MANOMETRO RADIALE 1/4

CODICE	DESCRIZIONE	CF	M.V.	PREZZO
08852 0600	6 bar	1	1	€ 7,00
08852 1000	10 bar	1	1	€ 7,00
08852 1600	16 bar	1	1	€ 7,00



## TERMOMANOMETRO 120°C 0-6 BAR

CODICE	DESCRIZIONE	CF	M.V.	PREZZO
08858 0120	1/2 - 0-120°C - 0-6 bar	1	1	€ 31,15



## MANOMETRO ATTACCO POSTERIORE 1/4

CODICE	DESCRIZIONE	CF	M.V.	PREZZO
08854 0600	0 - 6 BAR - DN 50	1	1	€ 7,00
08854 1000	0 - 10 BAR - DN 50	1	1	€ 7,00
08854 1600	0 - 16 BAR - DN 50	1	1	€ 7,00



## MANOMETRO ATTACCO POSTERIORE 1/4

CODICE	DESCRIZIONE	CF	M.V.	PREZZO
08856 1000	0 - 10 BAR - DN 63	1	1	€ 7,53





## IDROSFERA

CODICE	DESCRIZIONE	CF	M.V.	PREZZO
08862 2400	LT 24	30	1	€ 48,33

- Corpo in acciaio verniciato membrana sostituibile in gomma per acqua uso alimentare e flangia in acciaio al carbonio zincata.



## MEMBRANA RICAMBIO PER IDROSFERA

CODICE	DESCRIZIONE	CF	M.V.	PREZZO
08860 2400	lt 24	1	1	€ 6,98



## IDROSFERA VERTICALE EASYTANK

CODICE	DESCRIZIONE	CF	M.V.	PREZZO
08866 0060	60 lt verticale	1	1	€ 201,00
08866 0080	80 lt verticale	1	1	€ 272,00
08866 0100	100 lt verticale	1	1	€ 317,00
08866 0300	300 lt verticale	1	1	€ 1.400,00

- Manometro integrato.  
- Piedini antivibranti.



## MEMBRANE DI RICAMBIO PER IDROSFERE BASY TANK

CODICE	DESCRIZIONE	CF	M.V.	PREZZO
08861 0060	LT 60	1	1	€ 57,50
08861 0080	LT 80-100	1	1	€ 82,50

## IDROSFERA ORIZZONTALE

CODICE	DESCRIZIONE	CF	M.V.	PREZZO
08864 0050	50 LT orizzontale	1	1	€ 199,50



## IDROSFERA POWER TANK - GARANZIA 5 ANNI

CODICE	DESCRIZIONE	CF	M.V.	PREZZO
08870 0024	lt 24 H 425	1	1	€ 81,00

- Si può utilizzare anche su impianti di riscaldamento.



## IDROSFERA POWER TANK - GARANZIA 5 ANNI

CODICE	DESCRIZIONE	CF	M.V.	PREZZO
08872 0060	lt 60 H 678	1	1	€ 246,27
08872 0080	lt 80 H 728	1	1	€ 311,42
08872 0100	lt 100 H 770	1	1	€ 385,60
08872 0150	lt 150 H 898	1	1	€ 765,00
08872 0200	lt 200 H 1100	1	1	€ 1.140,00

- Si può utilizzare anche su impianti di riscaldamento.



## GALLEGGIANTE ELETTRICO GUARDIAN

CODICE	DESCRIZIONE	CF	M.V.	PREZZO
08891 0200	MT 2	1	1	€ 15,00
08891 0500	MT 5	1	1	€ 20,80

- Protezione IP68.
- Cavo neopreme.
- Contrappeso di serie.
- Ampere 10 (6a).





## GALLEGGIANTI ELETTRICI MAC3

CODICE	DESCRIZIONE	CF	M.V.	PREZZO
08890 0200	galleggiante doppio isolamento - mt. 2	1	1	€ 25,00
08890 0300	galleggiante doppio isolamento - mt. 3	1	1	€ 28,50
08890 0500	galleggiante doppio isolamento - mt. 5	1	1	€ 37,00
08890 1000	galleggiante doppio isolamento - mt. 10	1	1	€ 57,50

- Per serbatoi da litri 24 a 500.



## GALLEGGIANTE ELETTRICO ESTERNO RIO

CODICE	DESCRIZIONE	CF	M.V.	PREZZO
08892 0000	galleggiante elettrico RIO esterno - mt. 3	1	1	€ 39,50



## WATER LEVEL A PILE 9V

CODICE	DESCRIZIONE	CF	M.V.	PREZZO
08894 0000	5 FILI	1	1	€ 53,15



## TUBO TRASPARENTE PER LIVELLO SERBATOI

CODICE	DESCRIZIONE	CF	M.V.	PREZZO
08898 0000	16 x 12	10	1	€ 21,50

## PORTAFILTRO 10"

CODICE	DESCRIZIONE	CF	M.V.	PREZZO
08902 0600	Trasparente 1"	12	1	€ 31,04
08902 0500	Trasparente 3/4"	12	1	€ 31,04



## PORTAFILTRO 7"

CODICE	DESCRIZIONE	CF	M.V.	PREZZO
08906 0500	Trasparente 3/4"	12	1	€ 26,25



## PORTAFILTRO 5"

CODICE	DESCRIZIONE	CF	M.V.	PREZZO
08908 0500	Trasparente 3/4"	12	1	€ 26,25



## OR DI RICAMBIO PER PORTAFILTRO

CODICE	DESCRIZIONE	CF	M.V.	PREZZO
08901 0000	--	1	1	€ 3,75





## STAFFA A MURO PER PORTAFILTRO

CODICE	DESCRIZIONE	CF	M.V.	PREZZO
08910 0100	Staffa singola plastica	1	1	€ 8,75
08910 0200	Staffa doppia plastica	1	1	€ 9,75



## CHIAVE PER PORTAFILTRO

CODICE	DESCRIZIONE	CF	M.V.	PREZZO
08912 0000	Chiave plastica	1	1	€ 5,70



## PORTAFILTRO 10"

CODICE	DESCRIZIONE	CF	M.V.	PREZZO
08905 0600	Opaco 1"	12	1	€ 27,50

- Completo di staffa e chiave.



## PORTAFILTRO ACCIAIO 10"

CODICE	DESCRIZIONE	CF	M.V.	PREZZO
08914 0500	3/4	1	1	€ 72,20

- Completo di staffa e chiave.

## PORTAFILTRO ANTICALCARE MIDI 10

CODICE	DESCRIZIONE	CF	M.V.	PREZZO
09292 0000	1/2"	1	1	€ 31,00

- Inserti in ottone.
- Completo di chiave e staffa.



## CARTUCCIA PER FILTRO A FILO AVVOLTO 10"

CODICE	DESCRIZIONE	CF	M.V.	PREZZO
08920 0500	5 u	72	1	€ 4,90
08920 1000	10 u	72	1	€ 4,90
08920 2000	20 u	72	1	€ 4,90



## CARTUCCIA PER FILTRO A FILO AVVOLTO 7"

CODICE	DESCRIZIONE	CF	M.V.	PREZZO
08919 2000	20 μ	1	1	€ 4,30



## CARTUCCIA PER FILTRO A FILO AVVOLTO 5"

CODICE	DESCRIZIONE	CF	M.V.	PREZZO
08918 2000	20 μ	1	1	€ 3,50





## CARTUCCE MELTBLOWN 9"/10"

CODICE	DESCRIZIONE	CF	M.V.	PREZZO
08922 0100	1 m	1	1	€ 4,75
08922 0500	5 m	1	1	€ 4,75
08922 1000	10 m	1	1	€ 4,75



## CARTUCCIA A RETE LAVABILE

CODICE	DESCRIZIONE	CF	M.V.	PREZZO
08924 0000	10"	1	1	€ 12,88



## CARTUCCIA AI SALI POLIFOSFATI

CODICE	DESCRIZIONE	CF	M.V.	PREZZO
08926 0500	Per portafiltro 5"	1	1	€ 17,00
08926 0700	Per portafiltro 7"	1	1	€ 22,50
08926 1000	Per portafiltro 10"	1	1	€ 32,50



## CARTUCCIA CARBONI ATTIVI

CODICE	DESCRIZIONE	CF	M.V.	PREZZO
08930 0000	10"	1	1	€ 18,50

## MINIFILTRO 3" C/CARTUCCIA INOX

CODICE	DESCRIZIONE	CF	M.V.	PREZZO
08915 0400	1/2"	1	1	€ 14,50

- Completa di cartuccia inox 80 micron



## PORTAFILTRO BIG BLUE 10"

CODICE	DESCRIZIONE	CF	M.V.	PREZZO
08907 0600	1"	1	1	€ 72,40

- PN 8 bar  
 - Completo di staffa e chiave  
 - Più grosso dei classici filtri per portate maggiori



## CARTUCCIA MELTBLOW BIG 10"

CODICE	DESCRIZIONE	CF	M.V.	PREZZO
08923 5000	50 μ	1	1	€ 21,00



**New**



## DEPURATORE OSMOSI INVERSA C/ACCUMULO

CODICE	DESCRIZIONE	CF	M.V.	PREZZO
08943 0000	P19 x L35 x H50	1	1	€ 350,00

Il kit comprende:

- Display alfanumerico
- Kit pre-filtri
- Filtro remineralizzatore
- Membrana osmotica 100 GPD
- Pompa 100 GPD
- Serbatoio accumulo acqua depurata
- Rubinetto e kit montaggio
- Penna TDS

**New**



## IMPIANTO TRATTAMENTO UV LUXE STERYL BASIC

CODICE	DESCRIZIONE	CF	M.V.	PREZZO
08932 0000	1 x 55W	1	1	€ 345,00

- Impianto per installazioni domestiche, fino a 2 famiglie
- MC/H 2,7; LT/MIN 45
- Realizzato in acciaio inox AISI 304
- Display digitale, c/contagiorni totale
- Durata media della lampada 9000 ore

**New**



## LAMPADE UV 4-ISTANT START

CODICE	DESCRIZIONE	CF	M.V.	PREZZO
08934 0040	40W - 435 MM	1	1	€ 100,00
08934 0055	55W - 900 MM	1	1	€ 100,00

## DEPURATORE OSMOSI INVERSA - 6 STADI DI FILTRAZIONE - "DUO"

CODICE	DESCRIZIONE	RIF. F.	CF	M.V.	PREZZO
08941 0000	P14xL38xH47	Xp6706	1	1	€ 1.064,00

- 1° STADIO - filtro sedimentatore 10 micr.
- 2° STADIO - filtro carbone granulare (assorbimento composti organici disciolti)
- 3° STADIO - filtro carbon block (rimozione cloro e cattivi odori)
- 4° STADIO - coppia membrana osmotiche 400GPD (eliminazione sali disciolti, organici, batteri)
- 4° STADIO - coppia membrana osmotiche 400GPD (eliminazione sali disciolti, organici, batteri)
- 5° STADIO - filtro al cocco (rimozione cattivi odori e sapori)
- 6° STADIO: - rinineralizzatore

- Produce acqua depurata ed acqua depurata alcalina
- Incluso kit di montaggio
- Incluso rubinetto 2 vie
- Incluso misuratore di conducibilità
- Produzione 120 lt/h
- Controllo conducibilità in entrata ed uscita.

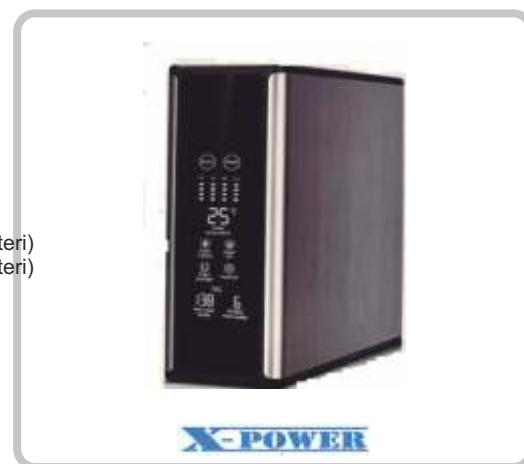

## FILTRI RICAMBIO PER OSMOSI "DUO"

CODICE	DESCRIZIONE	CF	M.V.	PREZZO
08941 0005	5 filtri	1	1	€ 113,50

- Sedimentatore 5 micron D. 2"
- Filtro gac 2"
- Sedimentatore 1 micron D. 2"
- Post filtro D. 2"
- Remineralizzatore D. 2"

**New**



## DEPURATORE ULTRAFILTRAZIONE 5 STADI

CODICE	DESCRIZIONE	CF	M.V.	PREZZO
08945 0000	P11 x L32 x H 40	1	1	€ 222,20

- 5 FILTRI:
- 1) Filtro per sedimenti 10 micron.
- 2) Filtro carbone granulare per togliere composti organici disciolti.
- 3) Filtro carbon block per rimuovere cloro e cattivi odori
- 4) Ultrafiltrazione fino a 0,001 micron.
- 5) Filtro coconut per rimuovere cattivi odori e sapori.

- Consigliato per acqua proveniente da acquedotto comunale.





## DEPURATORE OSMOSI INVERSA SOTTO ZOCCOLO SILVERBOX VP

CODICE	DESCRIZIONE	CF	M.V.	PREZZO
08939 0000	LT/H 70	1	1	€ 1.760,00



## FRIGOGASATORE FRIGOMAX60

CODICE	DESCRIZIONE	RIF. F.	CF	M.V.	PREZZO
08946 0000	P39xL25xH40	XPF600	1	1	€ 2.700,00
09846 0001	Kit montaggio optional		1	1	€ 350,00

- Produzione di acqua naturale fredda.
- Produzione di acqua naturale ambiente.
- Produzione di acqua frizzante fredda.
- Produzione max 60 lt/h.
- Optional bombola CO2.
- Optional ultrafiltrazione.
- Optional kit di montaggio e contalitri.
- Optional rubinetto a 3 vie.



## RUBINETTO OSMOSI C/LEVA

CODICE	DESCRIZIONE	CF	M.V.	PREZZO
08942 0000	--	1	1	€ 41,25

## ADDOLCITORE DOLPHIN

CODICE	BOMBOLA	MISURE	SALAMOIA	CAP. RESINA	ATTACCO	PREZZO
08952 0017	10x17"	500x325xH680	30 Lt	12,5	3/4	€ 1.050,00
08952 0035	10x35"	500x325xH1150	60 Lt	26	3/4	€ 1.350,00

- In dotazione kit bypass
- In dotazione kit analisi durezza.



## ADDOLCITORI EQUO SOFT

CODICE	MODELLO	BOMBOLA	MISURE	SALAMOIA	CAP. RESINA	CAP. CICLICA	PREZZO
08950 3600	Mini	10"x17"	686x386xH637	36Lt	12	66	€ 1.320,00
08950 7800	Maxi	10"x35"	686x386xH1040	78Lt	28	154	€ 1.470,00

- Completo di bypass

Gli addolcitori EQUO SOFT si avvalgono di una centralina computerizzata che fornisce all'utente tutte le informazioni sulla programmazione ecc. Sono provvisti di sistema automatico di rigenerazione delle resine, in modalità TEMPO/VOLUME. By-PASS fornito di serie.



## ADDOLCITORE EUROCLEAR BICORPO

CODICE	BOMBOLA	MISURE	SALAMOIA	CAP. RESINA	ATTACCO	PREZZO
08956 0036	10x44"	DM26xH153	70 Lt	36	1"	€ 1.355,00
08956 0045	10x54"	DM26xH153	70 Lt	45	1"	€ 1.452,00
08956 0075	13x54"	DM33xH153	100 Lt	75	1"	€ 1.889,00
08956 0110	14x65"	DM33xH176	150 Lt	110	1"	€ 2.689,00

- Completo di bypass da 1"
- In dotazione kit analisi di durezza.





## KIT DUREZZA MONOCOMPONENTE

CODICE	DESCRIZIONE	CF	M.V.	PREZZO
08954 0000	---	1	1	€ 20,75

- Semplice da usare, ad ogni goccia corrisponde un grado francese di durezza.



## SALE IN PASTIGLIE PER ADDOLCITORE

CODICE	DESCRIZIONE	CF	M.V.	PREZZO
08958 0010	Kg 10	1	1	€ 7,35
08958 0025	Kg 25	40	1	€ 15,70



## TUBO ALTA PRESSIONE PER OSMOSI

CODICE	DESCRIZIONE	CF	M.V.	PREZZO
08970 0600	DM 6	1	1	€ 1,94
08970 0800	DM 8	1	1	€ 2,57
08970 1000	DM 10	1	1	€ 2,57



## MANICOTTO RAPIDO

CODICE	DESCRIZIONE	CF	M.V.	PREZZO
08972 0600	DM 6	10	1	€ 2,26
08972 0800	DM 8	10	1	€ 2,73
08972 1000	DM 10	10	1	€ 3,22



## MANICOTTO RAPIDO FILETTATO M

CODICE	DESCRIZIONE	CF	M.V.	PREZZO
08973 0602	DM6x1/4	10	1	€ 2,57
08973 0803	DM8x3/8	10	1	€ 3,49
08973 1000	DM10x3/8	10	1	€ 4,38



## MANICOTTO RAPIDO FILETTATO F

CODICE	DESCRIZIONE	CF	M.V.	PREZZO
08974 0602	DM6x1/4	10	1	€ 3,36
08974 0803	DM8x1/4	10	1	€ 3,36
08974 1003	DM10x3/8	10	1	€ 4,73





## GOMITO ALTA PRESSIONE

CODICE	DESCRIZIONE	CF	M.V.	PREZZO
08976 0600	Dm6	10	1	€ 2,91
08976 0800	DM8	10	1	€ 2,91
08976 1000	DM10	10	1	€ 2,91



## TES ALTA PRESSIONE

CODICE	DESCRIZIONE	CF	M.V.	PREZZO
08979 0600	DM6	10	1	€ 4,52
08976 0800	DM8	10	1	€ 4,94
08979 1000	DM10	10	1	€ 5,59

## RIDUTTORE DI PRESSIONE MIGNON

CODICE	DESCRIZIONE	CF	M.V.	PREZZO
08962 0500	3/4	1	1	€ 34,86



## RIDUTTORE DI PRESSIONE NICHELATO

CODICE	DESCRIZIONE	RIF. F.	CF	M.V.	PREZZO
08964 0400	1/2	501.1/2	1	1	€ 50,88
08964 0500	3/4	501.3/4	1	1	€ 55,83



**FARG**

## RIDUTTORE DI PRESSIONE PESANTE BOCCHETTONATO

CODICE	DESCRIZIONE	RIF. F.	CF	M.V.	PREZZO
08966 0400	1/2	502.1/2	1	1	€ 70,81



**FARG**

## STAFFA ESTENSIBILE PER VASO ESPANSIONE

CODICE	DESCRIZIONE	CF	M.V.	PREZZO
09014 0605	1" x 3/4	1	1	€ 45,00



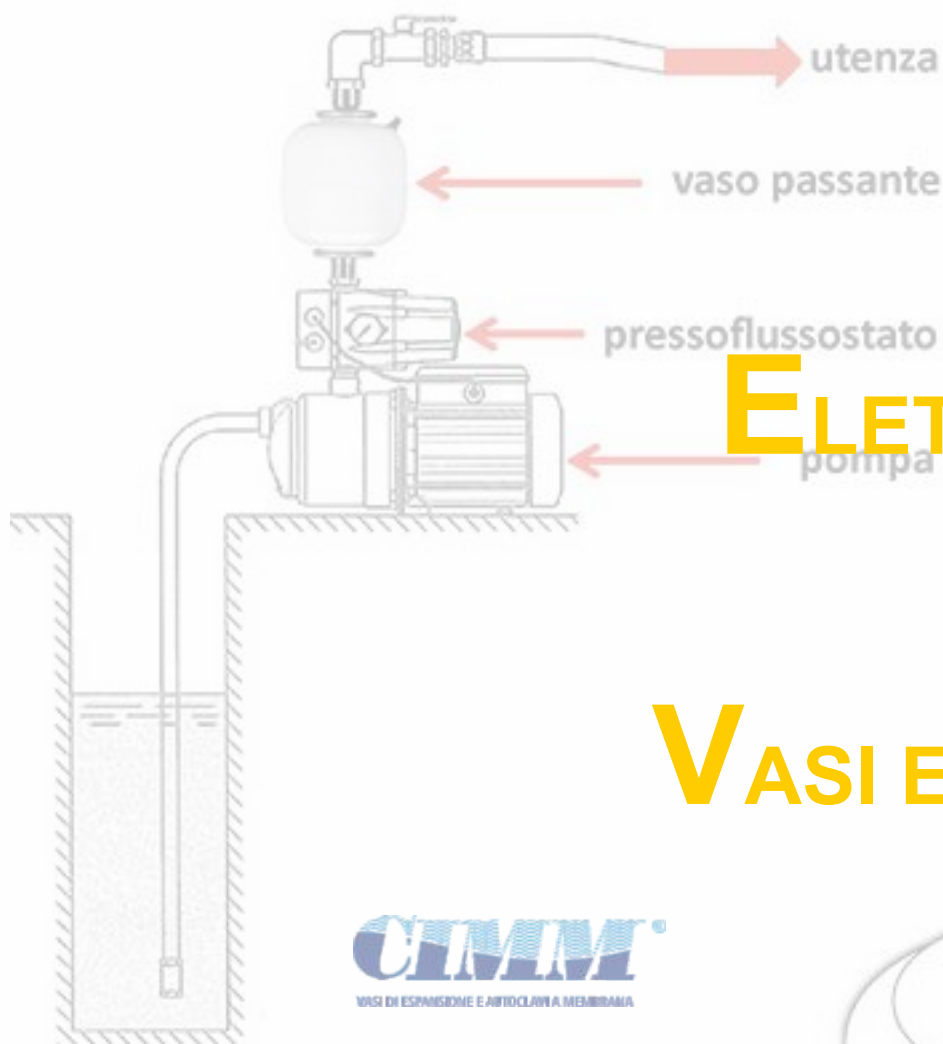

**ELETTROPOMPE**



**VASI ESPANSIONE**



**PRESSCONTROL**



**ADDOLCITORI**



**FILTRI ACQUA**

# RISCALDAMENTO

*Il successo non è definitivo,  
il fallimento non è fatale.  
È il coraggio di andare avanti che conta.*

*Winston Churchill*





**V**ALVOLE PER RADIATORI

**C**OLLETTORI



**R**ADIATORI



**S**CALDASALVIETTE



**zehnder**

**V**ENTILCONVETTORI



**C**ALDAIE A GAS



**C**HILLER



## VALVOLA MERCURY A SQUADRA

CODICE	DESCRIZIONE	CF	M.V.	PREZZO
09000 0304	3/8 x 1/2	10	1	€ 9,75
09000 0404	1/2 x 1/2	10	1	€ 11,37

- Valvola manuale a regolazione semplice, a squadra, con attacco per adattatori tubo rame, plastica o multistrato.



## DETENTORE MERCURY A SQUADRA

CODICE	DESCRIZIONE	CF	M.V.	PREZZO
09002 0304	3/8 x 1/2	10	1	€ 8,93
09002 0404	1/2 x 1/2	10	1	€ 9,75

- Detentore a squadra, con attacco per adattatori tubo rame, plastica o multistrato.



## VALVOLA MERCURY DRITTA

CODICE	DESCRIZIONE	CF	M.V.	PREZZO
09004 0304	3/8 x 1/2	10	1	€ 11,63
09004 0404	1/2 x 1/2	10	1	€ 13,80

- Valvola manuale a regolazione semplice, dritta, con attacco per adattatore tubo rame, plastica o multistrato.



## DETENTORE MERCURY DRITTO

CODICE	DESCRIZIONE	CF	M.V.	PREZZO
09006 0304	3/8 x 1/2	10	1	€ 10,80
09006 0404	1/2 x 1/2	10	1	€ 13,00

- Detentore manuale a regolazione semplice, dritto, con attacco per adattatore tubo rame, plastica o multistrato.



# K1 - VALVOLE E DETENTORI PER RADIATORI IVR



## VALVOLA SATURN TERMOSTABILIZZABILE SQUADRA

CODICE	DESCRIZIONE	CF	M.V.	PREZZO
09007 0304	3/8 x 1/2	10	1	€ 13,09
09007 0404	1/2 x 1/2	10	1	€ 13,92



## VALVOLA SATURN TERMOSTABILIZZABILE DRITTA

CODICE	DESCRIZIONE	CF	M.V.	PREZZO
09008 0304	3/8 x 1/2	10	1	€ 15,22
09008 0404	1/2 x 1/2	10	1	€ 15,22



## TESTA TERMOSTATICA IVR 597

CODICE	DESCRIZIONE	CF	M.V.	PREZZO
09009 0000	M30 x 1,5	1	1	€ 16,19

- Con sensore liquido.



## KIT RIQUALIFICAZIONE IVR

CODICE	DESCRIZIONE	CF	M.V.	PREZZO
09010 0304	3/8	20	1	€ 37,25
09010 0404	1/2	20	1	€ 38,75



## KIT VALVOLA + DETENTORE A SQUADRA 1/2

CODICE	DESCRIZIONE	CF	M.V.	PREZZO
09040 0404	½ x ½ Bianco	1	1	€ 74,80



## KIT VALVOLA + DETENTORE A SQUADRA 1/2

CODICE	DESCRIZIONE	CF	M.V.	PREZZO
09042 0000	½ x ½ Cromato	1	1	€ 74,80



## KIT VALVOLA + DETENTORE A SQUADRA 1/2

CODICE	DESCRIZIONE	CF	M.V.	PREZZO
09044 0000	½ x ½ Nero	1	1	€ 96,25



## KIT RIQUALIFICAZIONE CROMATO

CODICE	DESCRIZIONE	CF	M.V.	PREZZO
09046 0000	½ a squadra	1	1	€ 92,00

- Attacchi ½"



# K2 - ADATTATORI PER VALVOLE RADIATORI



## ADATTATORE CROMATO PER TUBO RAME

CODICE	DESCRIZIONE	CF	M.V.	PREZZO
09050 0412	12 x ½	2	1	€ 5,72



## ADATTATORE CROMATO PER TUBO MULTISTRATO

CODICE	DESCRIZIONE	CF	M.V.	PREZZO
09050 0416	16x2 x ½	2	1	€ 6,01



## ADATTATORE PER TUBI IN RAME

CODICE	DESCRIZIONE	CF	M.V.	PREZZO
09020 0410	DM 10 x ½	20	2	€ 2,89
09020 0412	DM 12 x ½	20	2	€ 2,89
09020 0414	DM 14 x ½	20	2	€ 3,03

- Compatibile anche con valvole APM.



## ADATTATORE PER TUBI MULTISTRATO

CODICE	DESCRIZIONE	CF	M.V.	PREZZO
09021 0416	DM 16 x ½	60	2	€ 2,81

- Compatibile anche con valvole APM.

# K3 - VALVOLE E DETENTORI PER RADIATORI ICMA

## VALVOLA PER RADIATORE A SQUADRA ICMA

CODICE	DESCRIZIONE	CF	M.V.	PREZZO
09060 0300	3/8	20	1	€ 7,07
09060 0400	1/2	20	1	€ 7,79



## DETENTORE A SQUADRA ICMA

CODICE	DESCRIZIONE	CF	M.V.	PREZZO
09062 0300	3/8	20	1	€ 7,07
09062 0400	1/2	20	1	€ 7,79



## VALVOLA PER RADIATORE DRITTA ICMA

CODICE	DESCRIZIONE	CF	M.V.	PREZZO
09061 0300	3/8	20	1	€ 14,75



## DETENTORE PER RADIATORE DRITTA ICMA

CODICE	DESCRIZIONE	CF	M.V.	PREZZO
09063 0300	3/8	20	1	€ 14,75



# K3 - VALVOLE E DETENTORI PER RADIATORI ICMA



## VALVOLA A SQUADRA TERMOSTABILIZZABILE ICMA

CODICE	DESCRIZIONE	CF	M.V.	PREZZO
09065 0300	3/8	20	1	€ 17,42
09065 0400	1/2	20	1	€ 18,29



## TESTA TERMOSTATICA ICMA

CODICE	DESCRIZIONE	CF	M.V.	PREZZO
09067 0000	M 30 x 1,5	1	1	€ 21,00

- Campo di regolazione temperatura 7-28 °C



## KIT RIQUALIFICAZIONE

CODICE	DESCRIZIONE	CF	M.V.	PREZZO
09064 0300	3/8	20	1	€ 43,45
09064 0400	1/2	20	1	€ 45,82



## ADATTATORE PER TUBI IN RAME

CODICE	DESCRIZIONE	CF	M.V.	PREZZO
09066 0410	10 x 1/2	1	1	€ 3,54
09066 0412	12 x 1/2	1	1	€ 3,54



## ADATTATORE PER TUBI MULTISTRATO

CODICE	DESCRIZIONE	CF	M.V.	PREZZO
09068 0416	16 x 1/2	1	1	€ 2,70

# VALVOLE E DETENTORI NERI PER TERMOARREDO



**NEW!**

## DESCRIZIONE

Valvole e detentori con finitura nero opaco per termoarredo corredati di bocchettone antigocciolamento.

## CARATTERISTICHE TECNICHE

**Fluidi di impiego:** acqua e soluzioni glicolate

**Percentuale max di glicole:** 50%

**Pressione max di esercizio:** 10 Bar

**Pressione max differenziale:** 1 Bar (con comando montato)

**Temperatura fluido termovettore:** 5 ÷ 120°C

**Connessione con testa termostatica:** 28 x 1,5

**Icma S.p.a.**

Via Garavaglia 4 Cuggiono (MI) - Italy  
+39 02 97 24 9134  
sales@icmaspa.it

**ICMA**<sup>®</sup>



WWW.ICMASPA.IT

Produciamo, orgogliosamente in Italia da oltre settant'anni, componenti per impianti di riscaldamento, condizionamento e distribuzione di acqua sanitaria nei settori residenziale, industriale e terziario. Realizziamo sistemi di climatizzazione radiante, privilegiando fonti energetiche rinnovabili, e soluzioni tecniche per la contabilizzazione dell'energia termica.



**GIACOMINI**  
WATER E-MOTION

# K4 - VALVOLE E DETENTORI PER RADIATORI GIACOMINI

## VALVOLA R25TG A SQUADRA

CODICE	DESCRIZIONE	CF	M.V.	PREZZO
09070 1603	Mis. 3/8"x16	1	1	€ 11,64
09070 1604	Mis. 1/2"x16	1	1	€ 13,40

- Valvola manuale a regolazione semplice, a squadra, in ottone, cromata, con attacco per adattatore.



## DETENTORE R29TG A SQUADRA

CODICE	DESCRIZIONE	CF	M.V.	PREZZO
09072 1603	Mis. 3/8"x16	1	1	€ 11,64
09072 1604	Mis. 1/2"x16	1	1	€ 12,05

- Detentore a squadra, in ottone, cromato, con attacco per adattatore tubo rame, plastica o multistrato.



## VALVOLA R27TG DRITTA

CODICE	DESCRIZIONE	CF	M.V.	PREZZO
09074 1603	Mis. 3/8"x16	1	1	€ 18,60
09074 1604	Mis. 1/2"x16	1	1	€ 20,10

- Valvola manuale a regolazione semplice, dritta, in ottone, cromata, con attacco per adattatore tubo rame, plastica o multistrato.



## DETENTORE R31TG DRITTO

CODICE	DESCRIZIONE	CF	M.V.	PREZZO
09076 1603	Mis. 3/8"x16	1	1	€ 14,56
09076 1604	Mis. 1/2"x16	1	1	€ 15,99

- Detentore dritto, in ottone, cromato, con attacco per adattatore tubo rame, plastica o multistrato.



# K4 - VALVOLE E DETENTORI PER RADIATORI GIACOMINI



## VALVOLA R431 A SQUADRA TERMOSTABILIZZABILE

CODICE	DESCRIZIONE	CF	M.V.	PREZZO
09078 1603	Mis. 3/8"x16	1	1	€ 18,60
09078 1604	Mis. 1/2"x16	1	1	€ 19,70

- Valvola micrometrica termostabilizzabile a squadra, cromata, con attacco per adattatore tubo rame, plastica o multistrato.



## VALVOLA R432TG DRITTA TERMOSTABILIZZABILE

CODICE	DESCRIZIONE	CF	M.V.	PREZZO
09080 1603	Mis. 3/8"x16	1	1	€ 26,17
09080 1604	Mis. 1/2 x16	1	1	€ 28,17

- Valvola micrometrica termostabilizzabile dritta, cromata, con attacco per adattatore tubo rame, plastica o multistrato.



## R470 TESTA TERMOSTATICA

CODICE	DESCRIZIONE	CF	M.V.	PREZZO
09082 0000	Testa termostatica a bassa inerzia con sensore a liquido, sistema di aggancio rapido CLIP CLAP.	1	1	€ 31,28



## KIT RIQUALIFICAZIONE ENERGETICO R470A

CODICE	DESCRIZIONE	CF	M.V.	PREZZO
09083 0300	3/8 a squadra	1	1	€ 60,78
09083 0400	1/2 a squadra	1	1	€ 62,15



# K4 - VALVOLE E DETENTORI PER RADIATORI GIACOMINI

## VALVOLA R421TG A SQUADA - ATTACCO FERRO TERMOSTABILIZZABILE

CODICE	DESCRIZIONE	CF	M.V.	PREZZO
09084 0303	3/8 x 3/8	1	1	€ 19,78
09084 0404	1/2 x 1/2	1	1	€ 20,55

- Valvola micrometrica termostabilizzabile a squadra, cromata, con attacco tubo ferro.



## DETENTORE R14TG A SQUADRA - ATTACCO FERRO

CODICE	DESCRIZIONE	CF	M.V.	PREZZO
09086 0303	3/8 x 3/8	1	1	€ 12,23
09086 0404	1/2 x 1/2	1	1	€ 12,78

- Detentore a squadra in ottone, cromato, con attacco tubo ferro.



## VALVOLA R422TG DRITTA - ATTACCO FERRO TERMOSTABILIZZABILE

CODICE	DESCRIZIONE	CF	M.V.	PREZZO
09088 0303	3/8 x 3/8	1	1	€ 28,75
09088 0404	1/2 x 1/2	1	1	€ 32,56

- Valvola micrometrica termostabilizzabile dritta, cromata, con attacco tubo ferro.



## DETENTORE R15TG DRITTO - ATTACCO FERRO

CODICE	DESCRIZIONE	CF	M.V.	PREZZO
09089 0303	3/8 x 3/8	1	1	€ 13,18
09089 0404	1/2 x 1/2	1	1	€ 15,27

- Detentore a squadra in ottone, cromato, con attacco tubo ferro.



# K5 - VALVOLE SFIATO PER RADIATORI



## ADATTATORE PER TUBI IN RAME

CODICE	DESCRIZIONE	CF	M.V.	PREZZO
09090 1610	16 x 10	50	1	€ 3,92
09090 1612	16 x 12	50	1	€ 3,92
09090 1614	16 x 14	1	1	€ 4,22



## ADATTATORE PER TUBI MULTISTRATO

CODICE	DESCRIZIONE	CF	M.V.	PREZZO
09092 1616	16 x (16x2)	25	1	€ 5,67
09092 1620	16 x (20x2)	25	1	€ 6,11



## R66A VALVOLA SFIATO

CODICE	DESCRIZIONE	CF	M.V.	PREZZO
09094 0100	Mis. 1/8	10	1	€ 2,29
09094 0200	Mis. 1/4"	50	1	€ 2,29
09094 0300	Mis. 3/8"	50	1	€ 2,87
09094 0400	Mis. 1/2"	25	1	€ 5,04

- Valvolina manuale di sfogo aria radiatori, con guarnizione autocontenuta.



## R200 VALVOLA SFIATO AUTOMATICA

CODICE	DESCRIZIONE	CF	M.V.	PREZZO
09096 0601	Mis. 1" dx	10	1	€ 24,82
09096 0602	Mis. 1" sx	10	1	€ 24,82
09096 0701	Mis. 1 1/4" dx	5	1	€ 26,95
09096 0702	Mis. 1 1/4" sx	5	1	€ 26,95

- Valvola automatica sfogo aria, in ottone, cromata.  
- Per radiatori. Con autotenuta e tappo di sicurezza.



## VALVOLA DI SFIATO A BARILOTTO

CODICE	DESCRIZIONE	CF	M.V.	PREZZO
09098 0300	3/8	10	1	€ 9,20
09098 0400	1/2	10	1	€ 9,20

**New**



## MENSOLA A PERCUSSIONE TELESCOPICA PER RADIATORI IN ALLUMINIO

CODICE	DESCRIZIONE	CF	M.V.	PREZZO
09100 0000	7x170 tassello 10x80 vern. bianca piatta	50	1	€ 1,87



## MENSOLA A PERCUSSIONE TELESCOPICA PER RADIATORI IN ALLUMINIO

CODICE	DESCRIZIONE	CF	M.V.	PREZZO
09102 0000	7x170 tassello 10x80 vern. bianca tonda	50	1	€ 2,08



## MENSOLA A PERCUSSIONE TELESCOPICA PER RADIATORI IN GHISA

CODICE	DESCRIZIONE	CF	M.V.	PREZZO
09104 2300	2/3 colonne	50	1	€ 9,30
09104 3400	3/4 colonne	50	1	€ 9,30
09104 5600	5/6 colonne	50	1	€ 9,50



**fischer**

## K6 - ACCESSORI PER RADIATORI



### BLISTER PER RADIATORI

CODICE	DESCRIZIONE	CF	M.V.	PREZZO
09106 0300	3/8	25	1	€ 6,70
09106 0400	1/2	25	1	€ 6,90



### BLISTER PER RADIATORI TUBOLARI

CODICE	DESCRIZIONE	CF	M.V.	PREZZO
09108 0000	1/2 x 1-1/4 (DM 56)	1	1	€ 14,18



**New**

### CHIAVE PLASTICA PER RADIATORI 1" E 1-1/4

CODICE	DESCRIZIONE	CF	M.V.	PREZZO
09109 0000	DM 17-22-25-28-32-40-41	1	1	€ 10,80

## GUARNIZIONI IN CARTONCINO PER RADIATORI ALLUMINIO

CODICE	DESCRIZIONE	CF	M.V.	PREZZO
09114 0010	41 x 33 x 1 mm	100	100	€ 0,13
09114 0005	41 x 33 x 0,5 mm	200	100	€ 0,12



## NIPPLES GIUNZIONE PER RADIATORI

CODICE	DESCRIZIONE	CF	M.V.	PREZZO
09116 0600	1"	100	1	€ 1,30
09116 0700	1-1/4	100	1	€ 1,45



## NIPPLES GIUNZIONE PER RADIATORI OSCAR

CODICE	DESCRIZIONE	CF	M.V.	PREZZO
09116 0603	1" MM 30	1	1	€ 1,50



## O-RING PER RADIATORI ALLUMINIO OSCAR

CODICE	DESCRIZIONE	CF	M.V.	PREZZO
09117 0000	38 x 32,5 x 25,5	1	1	€ 0,63



# K7 - CASSETTE PER COLLETTORI



## ROSETTA BIANCA IN PLASTICA UNIVERSALE

CODICE	DESCRIZIONE	CF	M.V.	PREZZO
09110 0000	8-16	100	1	€ 0,18



## ROSETTA IN PLASTICA COPRITUBO

CODICE	DESCRIZIONE	CF	M.V.	PREZZO
09112 0100	8-16 Bianca	30	1	€ 0,32
09112 0200	8-16 Cromata	1	1	€ 1,26



## CASSETTA PER COLLETTORI

CODICE	DESCRIZIONE	CF	M.V.	PREZZO
09140 0320	280 x 320 x 80	5	1	€ 24,96
09140 0420	300 x 420 x 80	5	1	€ 27,00
09140 0520	320 x 520 x 80	5	1	€ 35,40
09140 0620	320 x 620 x 80	5	1	€ 53,00

 DAMAST



## CASSETTE PER COLLETTORI

CODICE	DESCRIZIONE	CF	M.V.	PREZZO
09142 0332	332x272x86 mm	1	1	€ 29,90
09142 0412	412x272x86 mm	1	1	€ 33,00
09142 0512	512x272x86 mm	1	1	€ 41,50
09142 0612	612x272x86 mm	1	1	€ 58,00

 IVR



## COLLETTORE OTTONE 3/4 X 1/2 INCLINATO C/RUBINETTI

CODICE	DESCRIZIONE	CF	M.V.	PREZZO
09130 0200	3/4 x 1/2 - 2 vie	40	1	€ 14,70
09130 0300	3/4 x 1/2 - 3 vie	35	1	€ 22,05
09130 0400	3/4 x 1/2 - 4 vie	25	1	€ 29,42



## COLLETTORE LINEARE 3/4 x 1/2

CODICE	DESCRIZIONE	CF	M.V.	PREZZO
09120 0200	M.3/4 2 vie 1/2x16	50	1	€ 8,92
09120 0300	M.3/4 3 vie 1/2x16	50	1	€ 13,46
09120 0400	M.3/4 4 vie 1/2x16	40	1	€ 17,90
09120 0500	M.3/4 5 vie 1/2x16	35	1	€ 23,42



## COLLETTORE OTTONE 1" x 1/2

CODICE	DESCRIZIONE	CF	M.V.	PREZZO
09124 0200	1" x 1/2 2 vie	50	1	€ 14,70
09124 0300	1" x 1/2 3 vie	40	1	€ 19,10
09124 0400	1" x 1/2 4 vie	25	1	€ 22,80



## COLLETTORE LINEARE 1-1/4 x 3/4

CODICE	DESCRIZIONE	CF	M.V.	PREZZO
09128 0200	1-1/4 x 3/4 - 2 vie	1	1	€ 38,24
09128 0300	1-1/4 x 3/4 - 3 vie	1	1	€ 59,03
09128 0400	1-1/4 x 3/4 - 4 vie	1	1	€ 76,64



**TIEMME**  
GENERAL ITALIAN TRADEMARK

## K8 - ADATTATORI PER COLLETTORI



### ADATTATORE PER TUBI IN RAME

CODICE	DESCRIZIONE	CF	M.V.	PREZZO
09020 0410	DM 10 x ½	2	1	€ 2,89
09020 0412	DM 12 x ½	2	1	€ 2,89
09020 0414	DM 14 x ½	2	1	€ 3,03



### ADATTATORE PER TUBI MULTISTRATO

CODICE	DESCRIZIONE	CF	M.V.	PREZZO
09022 0416	DM 16 x ½	60	2	€ 2,53



### ADATTATORE 3/4 PER TUBI MULTISTRATO

CODICE	DESCRIZIONE	CF	M.V.	PREZZO
09154 0516	DM 16 x 3/4	10	1	€ 5,00
09154 0520	DM 20 x 3/4	10	1	€ 5,58

## COLLETTORE CON RUBINETTO MULTIFAR

CODICE	DESCRIZIONE	CF	M.V.	PREZZO
09160 0200	2 vie	25	1	€ 37,40
09160 0300	3 vie	25	1	€ 52,63
09160 0400	4 vie	25	1	€ 68,42

- Cromato
- 3/4 per uscita 24



## TAPPO MASCHIO PER COLLETTORE 3/4 CROMATO

CODICE	DESCRIZIONE	CF	M.V.	PREZZO
09166 0500	3/4	25	1	€ 4,35



## TAPPO FEMMINA PER COLLETTORE 3/4 CROMATO

CODICE	DESCRIZIONE	CF	M.V.	PREZZO
09167 0500	3/4	40	1	€ 3,80



## GOMITO FF RIDOTTO PER COLLETTORR 3/4 CROMATO

CODICE	DESCRIZIONE	CF	M.V.	PREZZO
09165 0500	3/4 x 1/2	30	1	€ 7,70



**New**



## ADATTATORE PER TUBO MULTISTRATO CALOTTA CROMATA

CODICE	DESCRIZIONE	CF	M.V.	PREZZO
09168 1600	16 x 2	50	1	€ 6,20
09168 2000	20 x 2	50	1	€ 6,20

**New**



## ADATTATORE PER TUBO RAME CALOTTA CROMATA

CODICE	DESCRIZIONE	CF	M.V.	PREZZO
09169 1000	∅ 10	100	1	€ 3,40
09169 1200	∅ 12	100	1	€ 3,40
09169 1400	∅ 14	100	1	€ 3,40

**New**



## CASSETTA PER COLLETTORE

CODICE	DESCRIZIONE	CF	M.V.	PREZZO
09162 0300	300 x 250 x 80	14	1	€ 35,90
09162 0400	400 x 250 x 80	12	1	€ 40,25
09162 0480	480 x 250 x 80	10	1	€ 48,00
09162 0600	600 x 300 x 80	5	1	€ 61,80

**New**



## COPPIA STAFFE PER COLLETTORE 3/4

CODICE	DESCRIZIONE	CF	M.V.	PREZZO
09164 0500	3/4	100	1	€ 5,25

## RADIATORI ALLUMINIO VOX EXTRA

CODICE	DESCRIZIONE	CF	PREZZO
09170 0500	INT. 500 $\Delta t$ 50K W 119	3-4-5-6-7-8-10	€ 27,45
09170 0600	INT. 600 $\Delta t$ 50K W 137	3-4-5-6-7-8-10	€ 28,58
09170 0700	INT. 700 $\Delta t$ 50K W 156	3-4-5-6-7-8-10	€ 32,34
09170 0800	INT. 800 $\Delta t$ 50K W 173	3-4-5-6-7-8-10	€ 35,07



## RADIATORI ALLUMINIO VIP

CODICE	DESCRIZIONE	CF	M.V.	PREZZO
09172 0600	INT. 600 $\Delta T$ 50K W 142,00	10	5	€ 28,58
09172 0700	INT. 700 $\Delta T$ 50K W 161,00	10	5	€ 32,34
09172 0800	INT. 800 $\Delta T$ 50K W 180,00	10	5	€ 35,07



## RADIATORI ALLUMINIO OSCAR TONDO

CODICE	DESCRIZIONE	CF	PREZZO
09176 1000	INT. 1000 $\Delta T$ 50K W 185,60	3-4-5-6	€ 73,71
09176 1200	INT. 1200 $\Delta T$ 50K W 214,00	3-4-5-6	€ 81,90
09176 1400	INT. 1400 $\Delta T$ 50K W 238,50	3-4-5-6	€ 85,26
09176 1600	INT. 1600 $\Delta T$ 50K W 262,60	3-4-5-6	€ 95,70
09176 1800	INT. 1800 $\Delta T$ 50K W 285,70	3-4-5-6	€ 111,96
09176 2000	INT. 2000 $\Delta T$ 50K W 308,60	3-4-5-6	€ 121,28



## RADIATORI ALLUMINIO OSCAR

CODICE	DESCRIZIONE	CF	PREZZO
09178 1800	INT. 1800 $\Delta t$ 50K W 297	3-4-5-6	€ 116,00
09178 2000	INT. 2000 $\Delta t$ 50K W 321	3-4-5-6	€ 125,58





## TERMOARREDO BIANCO BORMIO

CODICE	Altezza mm	Larghezza mm	Interasse mm	Watt $\Delta T 50^{\circ}C$	PREZZO
09191 8045	803	450	400	304	€ 72,08
09191 8050	803	500	450	331	€ 73,14
09191 8055	803	550	500	359	€ 75,26
09191 8060	803	600	550	386	€ 76,32
09191 1245	1188	450	400	454	€ 93,28
09191 1250	1188	500	450	496	€ 94,34
09191 1255	1188	550	500	538	€ 96,46
09191 1260	1188	600	550	580	€ 100,70
09191 1445	1400	450	400	538	€ 100,70
09191 1450	1400	500	450	588	€ 107,06
09191 1455	1400	550	500	637	€ 110,24
09191 1460	1400	600	550	687	€ 114,48
09191 1650	1600	500	450	679	€ 120,84
09191 1655	1600	550	500	736	€ 127,20
09191 1845	1785	450	400	699	€ 131,44
09191 1850	1785	500	450	763	€ 134,62
09191 1855	1785	550	500	827	€ 140,98
09191 1860	1785	600	550	891	€ 145,22



## TERMOARREDO CROMATO BOLZANO

CODICE	Altezza mm	Larghezza mm	Interasse mm	Watt $\Delta T 50^{\circ}C$	PREZZO
09193 1245	1188	450	400	316	€ 224,72
09193 1250	1188	500	450	345	€ 228,96
09193 1255	1188	550	500	374	€ 233,20
09193 1260	1188	600	550	402	€ 245,92
09193 1445	1400	450	400	372	€ 254,40
09193 1450	1400	500	450	406	€ 257,58
09193 1455	1400	550	500	441	€ 261,82
09193 1460	1400	600	550	475	€ 272,42
09193 1850	1785	500	450	524	€ 336,02
09193 1860	1785	600	550	614	€ 364,64



## SCALDASALVIETTE CROMATO

CODICE	Altezza mm	Larghezza mm	Interasse mm	Watt $\Delta$ T 50°C	PREZZO
09192 0745	750	450	400	243	€ 151,38
09192 0750	750	500	450	261	€ 156,98
09192 0755	750	550	500	280	€ 164,98
09192 0760	750	600	550	298	€ 170,26
09192 1545	1500	450	400	459	€ 277,41
09192 1745	1760	450	400	531	€ 318,26

- Fino ad esaurimento scorte.

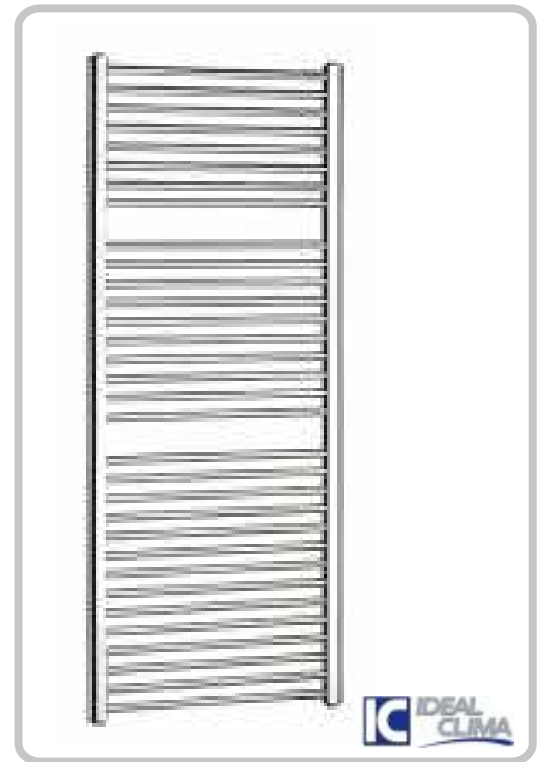

## SCALDASALVIETTE ELETTRICO BIANCO

CODICE	Altezza mm	Larghezza mm	Watt $\Delta$ T 50°C	PREZZO
09196 1150	1150	500	400	€ 288,00
09196 1650	1600	500	750	€ 348,00
09196 1750	1760	500	750	€ 388,00



## KIT FISSAGGI PER TERMOARREDI

CODICE	DESCRIZIONE	CF	M.V.	PREZZO
09197 0000	Bianco	1	1	€ 16,00



**New**

# K12 - VENTILCONVETTORI VENTILCLIMA

**New**



**Ventilclima**  
PER CLIMA COMFORT

## VENTILCONVETTORE CENTRIFUGO MODI V-M 3R

CODICE	MODELLO	RAFF.	RISC.	CF	M.V.	PREZZO
09225 0010	10 - V-M	1,34	1,55	1	1	€ 447,30
09225 0020	20 - V-M	2,19	2,25	1	1	€ 506,80
09225 0030	30 - V-M	3,10	2,95	1	1	€ 572,50
09225 0040	40 - V-M	3,60	3,51	1	1	€ 641,50
09225 0050	50 - V-M	4,61	4,58	1	1	€ 724,00
09225 0070	70 - V-M	6,46	6,54	1	1	€ 946,50
09225 0090	90 - V-M	8,94	9,70	1	1	€ 1.563,00

- Verticale/Orizzontale
- Ripresa aria inferiore
- Griglie fisse
- Attacchi sinistri

**New**



**Ventilclima**  
PER CLIMA COMFORT

## TERMOSTATO ELETTRONICO I-BASIC

CODICE	DESCRIZIONE	CF	M.V.	PREZZO
09226 0000	Elettronico	1	1	€ 97,50

**New**



**Ventilclima**  
PER CLIMA COMFORT

## PIEDINI PER VENTILCONVETTORI MODI V-M

CODICE	DESCRIZIONE	CF	M.V.	PREZZO
09228 0000	--	1	1	€ 53,50

- Preverniciati
- Prezzo riferito alla coppia



## Terminali per pompe di calore

Per una riqualificazione completa che massimizza l'efficienza

### Comfort climatico ad alta efficienza

La sostituzione della caldaia a gas con una pompa di calore è il primo passo per elettrificare ed efficientare un edificio. In assenza di un efficace isolamento dell'involucro e/o in presenza di terminali che funzionano a temperature elevate (come i radiatori), l'efficienza complessiva del sistema potrebbe tuttavia essere penalizzata. Grazie al funzionamento a bassa temperatura (circa 45°C contro i 65/70°C dei radiatori) i ventilconvettori sono i terminali ideali per garantire il corretto funzionamento della pompa di calore, per un comfort più efficiente.

### Massimo benessere acustico, con la tecnologia radiante

I ventilconvettori Bi2 sono disponibili anche nella versione ventilradiatore - con pannello radiante tubolare - che permette il funzionamento statico della macchina in riscaldamento (ventilatore spento), per una completa assenza di rumore.

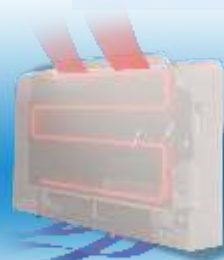

# K13 - VENTILCONVETTORI OLIMPIA SPLENDID



## VENTILCONVETTORE SLIM SL AIR INVERTER OLIMPIA SPLENDID

CODICE	MOD.	Dimensioni LxPxH	Resa freddo	Resa caldo	PREZZO
09200 0200	SL 200	695x129x599	0,82	1,05	€ 925,00
09200 0400	SL 400	895x129x599	1,74	2,31	€ 998,00
09200 0600	SL 600	1095x129x599	2,54	3,12	€ 1.137,00
09200 0800	SL 800	1295x129x599	3,29	4,10	€ 1.312,00
09200 1000	SL 1000	1495x129x599	3,78	4,67	€ 1.437,00

- Dotato di comando touch a bordo macchina e telecomando.
- Ventilatore tangenziale.
- Motore elettrico DC Brushless.
- Riscalda, rinfresca, deumidifica e filtra.
- Filtri estraibili.
- Spessore minimo 129 mm.

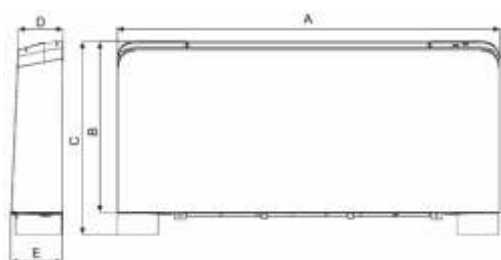

		200	400	600	800	1000
A	mm	695	895	1095	1295	1495
B	mm	599	599	599	599	599
C	mm	679	679	679	679	679
D	mm	129	129	129	129	129
E	mm	150	150	150	150	150
Peso netto SL	kg	11.5	13.0	15.5	18.5	21.5
Peso netto SLR	kg	13.5	15.5	19.5	22.5	25.5



## VENTILCONVETTORE SLIM SL AIR INVERTER ALTA POTENZA

CODICE	MOD.	Dimensioni LxPxH	Resa freddo	Resa caldo	PREZZO
09202 1400	SL 1400	1345x179x599	4,45	5,50	€ 1.712,00
09202 1600	SL 1600	1415x179x599	4,85	5,90	€ 1.887,00

- Dotato di comando touch a bordo macchina e telecomando.
- Ventilatore tangenziale.
- Motore elettrico DC Brushless.
- Riscalda, rinfresca, deumidifica e filtra.
- Filtri estraibili.
- Spessore minimo 179 mm.

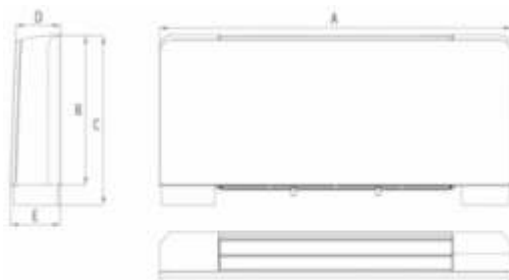

		1400	1600
A	mm	1345	1415
B	mm	599	599
C	mm	719	719
D	mm	179	179
E	mm	200	200
Peso netto SL	kg	22.5	24
Peso netto SLR	kg	24.5	26

# K13 - VENTILCONVETTORI OLIMPIA SPLENDID

## VENTILCONVETTORE HIGH-WALL SLIM INVERTER OLIMPIA SPLENDID

CODICE	MOD.	Dimensioni LxPxH	Resa freddo	Resa caldo	PREZZO
09206 0400	SLW 400	906x129x380	1,01	1,55	€ 1.257,00
09206 0600	SLW 600	1106x129x380	1,23	2,16	€ 1.360,00
09206 0800	SLW 800	1306x129x380	1,82	2,85	€ 1.493,00

- Dotato di comando touch a bordo macchina e telecomando.
- Ventilatore tangenziale.
- Motore elettrico DC Brushless.
- Riscalda, rinfresca, deumidifica e filtra.
- Filtri estraibili.
- Spessore minimo 129 mm.
- Fornito con valvola 2 o 3 vie integrata con attuatore elettrotermico a 4 fili.
- Possibilità di ruotare lo split e montarlo come consolle.



		400	600	800
A	mm	906	1106	1306
B	mm	380	380	380
C	mm	129	129	129
D	mm	150	150	150
Peso netto	kg	13	14,5	16



## VENTILCONVETTORE HIGH-WALL INVERTER ALTA POTENZA

CODICE	MOD.	Dimensioni LxPxH	Resa freddo	Resa caldo	PREZZO
09209 1000	SLW 1000	940x303x226	2,40	3,31	€ 1.325,00
09209 1200	SLW 1200	940x303x226	3,10	4,17	€ 1.388,00
09209 1400	SLW 1400	940x303x226	3,90	5,05	€ 1.438,00

- Dotato di telecomando.
- Climatizza, deumidifica, riscalda e filtra.
- Motore elettrico DC Brushless.
- Valvola a 3 vie integrata.



		1000	1200	1400
A	mm	940	940	940
B	mm	303	303	303
C	mm	226	226	226
Peso netto	kg	11	12	12



# K13 - VENTILCONVETTORI OLIMPIA SPLENDID



## VENTILCONVETTORE SLIM INCASSO INVERTER SLI

CODICE	MOD.	Resa freddo	Resa caldo	PREZZO
09212 0200	SLI 200	0,82	1,05	€ 560,00
09212 0400	SLI 400	1,74	2,31	€ 625,00
09212 0600	SLI 600	2,54	3,12	€ 740,00
09212 0800	SLI 800	3,29	4,10	€ 870,00
09212 1000	SLI 1000	3,78	4,67	€ 1.025,00

- Ingombro ridotto spessore solo 14,2 cm.
- Climatizza, deumidifica, riscalda e filtra.
- Motore elettrico DC Brushless.

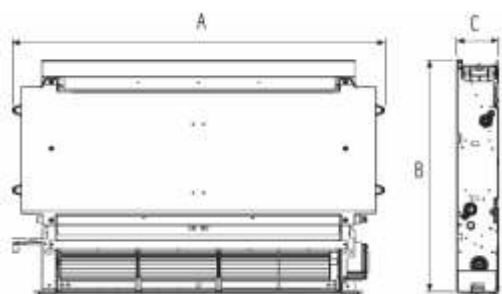

		200	400	600	800	1000
A	mm	525	725	925	1125	1325
B	mm	576	576	576	576	576
C	mm	126	126	126	126	126
Peso netto SLI	kg	7	9,5	11	14	17
Peso netto SLIR	kg	9	12	15	18	21



## VENTILCONVETTORE SLIM INCASSO INVERTER ALTA POTENZA

CODICE	MOD.	Resa freddo	Resa caldo	PREZZO
09214 1400	SLI 1400	4,45	5,50	€ 1.288,00
09214 1600	SLI 1600	4,85	5,90	€ 1.429,00

- Ingombro ridotto spessore solo 21,7 cm.
- Climatizza, deumidifica, riscalda e filtra.
- Motore elettrico DC Brushless.

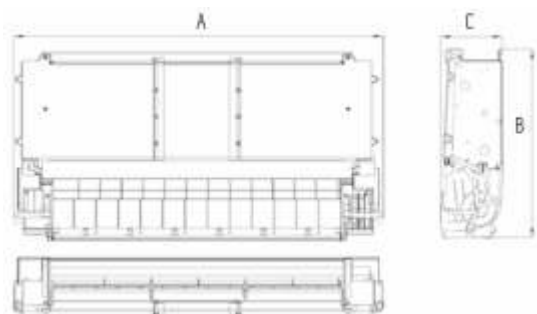

		1400	1600
A	mm	1110	1180
B	mm	599	599
C	mm	198	198
Peso netto SLI	kg	18	19,5
Peso netto SLIR	kg	20	21

# K13 - VENTILCONVETTORI OLIMPIA SPLENDID

## CASSAFORME INCASSO OLIMPIA SPLENDID

CODICE	DESCRIZIONE	M.V.	PREZZO
09216 0200	PER SLI 200	1	€ 135,00
09216 0400	PER SLI 400	1	€ 150,00
09216 0600	PER SLI 600	1	€ 160,00
09216 0800	PER SLI 800	1	€ 178,00
09216 1000	PER SLI 1000	1	€ 198,00
09216 1400	PER SLI 1400	1	€ 347,00
09216 1600	PER SLI 1600	1	€ 347,00



		200	400	600	800	1000
<b>A</b>	mm	713	913	1113	1313	1513
<b>B</b>	mm	725	725	725	725	725
<b>C</b>	mm	142	142	142	142	142

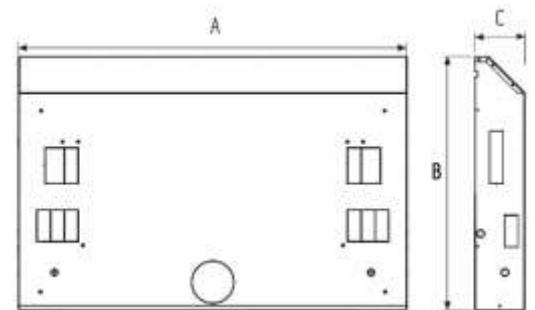

## PANNELLO ESTETICO DI CHIUSURA PER VENTILCONVETTORE INCASSO

CODICE	DESCRIZIONE	M.V.	PREZZO
09218 0200	PER SLI 200	1	€ 594,00
09218 0400	PER SLI 400	1	€ 667,00
09218 0600	PER SLI 600	1	€ 720,00
09218 0800	PER SLI 800	1	€ 770,00
09218 1000	PER SLI 1000	1	€ 825,00
09218 1400	PER SLI 1400	1	€ 875,00
09218 1600	PER SLI 1600	1	€ 890,00



		200	400	600	800	1000
<b>A</b>	mm	772	972	1172	1372	1572
<b>B</b>	mm	754	754	754	754	754

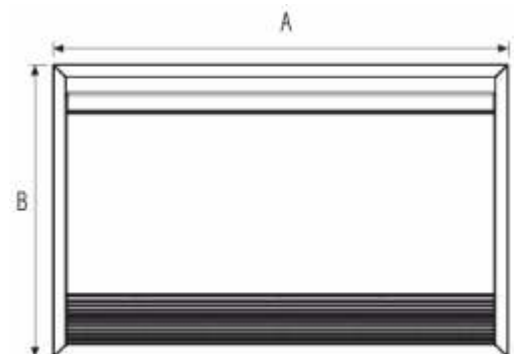



## KIT TERMOSTATO PARETE TOUCH A CONTATTI

CODICE	DESCRIZIONE	CF	M.V.	PREZZO
09220 0000	---	1	1	€ 398,00

- Incluso scheda bordo macchina.
- Termostato digitale con sonda ambiente, display retroilluminato e pulsanti touch.
- Installazione semincasso (15 mm uscente dalla parete) in scatole con interasse, viti 60 mm tonde o quadrate.
- Visualizzazione della temperatura ambiente desiderata da 5°C a 35°C, impostazione modalità "raffreddamento" o "riscaldamento", impostazione velocità del ventilatore (Min./Med./Max).
- Alimentazione a 230 V AC, dispone di una uscita elettrovalvola e di un ingresso sonda temperatura acqua.
- Abbinamento possibile con schede per remotizzazione AR, B0756 e B0873.



**New**

## TERMOSTATO AMBIENTE CEWAL ON/OFF

CODICE	DESCRIZIONE	CF	M.V.	PREZZO
91935 0030	--	1	1	€ 27,25



**New**

## CRONOMETRO CEWAL C/CAVALIERI

CODICE	DESCRIZIONE	CF	M.V.	PREZZO
91940 9350	2 livelli di temperatura	1	1	€ 71,50



**New**

## CRONOMETRO DIGITALE CEWAL C/CAVALIERI LIFE

CODICE	DESCRIZIONE	CF	M.V.	PREZZO
91945 0150	Digitale	1	1	€ 80,00

## CRNOTERMOSTATO GIORNALIERO FREETIME SEITRON

CODICE	DESCRIZIONE	CF	M.V.	PREZZO
09264 0000	Freetime	1	1	€ 101,00

- 3 livelli di temperatura, differenziale regolabile.
- Predisposizione per sonda esterna.

*Disponibile da settembre.*



## CRNOTERMOSTATO DIGITALE GIORNALIERO

CODICE	DESCRIZIONE	CF	M.V.	PREZZO
09268 0000	Freetime evo	1	1	€ 104,00

- Programmazione semplice ed affidabile.
- Adatto al controllo di impianti di riscaldamento e raffrescamento tramite un'uscita a relè con contatti di scambio (C, CN, NO).
- 2 livelli di temperatura: confort e riduzione.

*Disponibile da settembre.*



## COPRICALDAIA E COPRISCALDABAGNO

CODICE	DESCRIZIONE	CF	M.V.	PREZZO
09240 0085	85x50x35	1	1	€ 93,60
09240 0102	102x55x45	1	1	€ 105,00



# K15 - CALDAIE CHAFFOTEAUX

**New**



 Chaffoteaux

## CALDAIA CX GREEN CHAFFOTEAUX

CODICE	DESCRIZIONE	CF	M.V.	PREZZO
09270 0024	24 kW metano	6	1	€ 1.497,00
09270 0029	29 kW metano	6	1	€ 1.779,00

**New**



 Chaffoteaux

## KIT FUMI COASSIALE CHAFFOTEAUX

CODICE	DESCRIZIONE	CF	M.V.	PREZZO
09276 0000	Coassiale	1	1	€ 47,50

**New**



 Chaffoteaux

## KIT FUMI SDOPPIATO CHAFFOTEAUX

CODICE	DESCRIZIONE	CF	M.V.	PREZZO
09278 0000	Sdoppiato	1	1	€ 39,50

## CALDAIA SMART - ITALTHERM

CODICE	DESCRIZIONE	CF	M.V.	PREZZO
09251 2500	25 K - GPL/Metano	1	1	€ 1.782,50



## CALDAIA CITY CLASS - ITALTHERM

CODICE	DESCRIZIONE	CF	M.V.	PREZZO
09250 2500	25 kW GPL/METANO	1	1	€ 2.011,00
09250 3000	30 kW GPL/METANO	1	1	€ 2.596,00
09250 3500	35 kW GPL/METANO	1	1	€ 2.921,00



## CALDAIA CITY OPEN - ITALTHERM

CODICE	DESCRIZIONE	CF	M.V.	PREZZO
09252 2500	25 KW GPL-METANO	1	1	€ 2.856,00

- Comando remoto di serie.



## CALDAIA CITY BOX - ITALTHERM

CODICE	DESCRIZIONE	CF	M.V.	PREZZO
09254 2500	25 KW GPL-METANO	1	1	€ 2.743,51

- Comando remoto di serie.



# K16 - CALDAIE A GAS ITALTHERM



## CASSONE INCASSO PER CALDAIA ITALTHERM

CODICE	DESCRIZIONE	CF	M.V.	PREZZO
09255 0000	Cassone per caldaia LxHxP 550x1140x250	1	1	€ 287,50



## KIT FUMI - ITALTHERM

CODICE	DESCRIZIONE	CF	M.V.	PREZZO
09256 0000	Kit coassiale	1	1	€ 82,02



## KIT FUMI

CODICE	DESCRIZIONE	CF	M.V.	PREZZO
09258 0000	Tronchetto sdoppiato	1	1	€ 64,20



## CRONOTERMOSTATO ITALTHERM

CODICE	DESCRIZIONE	CF	M.V.	PREZZO
09259 0000	Modulante evoluto	1	1	€ 345,00

- Per city class, top, open e box.
- Non necessita di sonda esterna.

## TERMOREGOLATORE PER TERMOCAMINO

CODICE	DESCRIZIONE	CF	M.V.	PREZZO
09270 0000	2 uscite	1	1	€ 123,85



## DEFANGATORE MAGNETICO COMPATTO

CODICE	DESCRIZIONE	CF	M.V.	PREZZO
09281 0000	3/4	1	1	€ 64,00

- Ideale per caldaie ad incasso.



## DEFANGATORE MAGNETICO OPITEC

CODICE	DESCRIZIONE	CF	M.V.	PREZZO
09282 0000	3/4 - In plastica	12	1	€ 60,00



## DEFANGATORE MAGNETICO MAG BLUE

CODICE	DESCRIZIONE	CF	M.V.	PREZZO
09283 0000	1"	1	1	€ 177,20

- Ottimo per pompe di calore.





## PORTAFILTRO ANTICALCARE MIDI 10

CODICE	DESCRIZIONE	CF	M.V.	PREZZO
09292 0000	1/2"	1	1	€ 34,20

- Inerti in ottone.
- Completo di chiave e staffa.



## DOSATORE SALI POLIFOSFATI

CODICE	DESCRIZIONE	CF	M.V.	PREZZO
09284 0000	c/by pass girevole 360°	12	1	€ 45,00



## CARTUCCIA RICARICA POLIFOSFATI

CODICE	DESCRIZIONE	CF	M.V.	PREZZO
09286 0000	6 pezzi - sfusi	15	1	€ 10,25
09286 0001	6 pezzi - in blister	32	1	€ 12,89

N.B. Il prezzo è riferito alla confezione da 6 pezzi.



## KIT UNIKO SALVA CALDAIA

CODICE	DESCRIZIONE	CF	M.V.	PREZZO
09288 0000	deflangatore + dosatore sali polifosfati + neutralizzatore di condensa	10	1	€ 137,50



SCALDABAGNI

E

SOLARE TERMICO

*Il perdono libera l'anima, rimuove la paura,  
è per questo che il perdono  
è un'arma potente.*

*Nelson Mandela*





# SCALDABAGNI



# RESISTENZE



# BOLLITORI

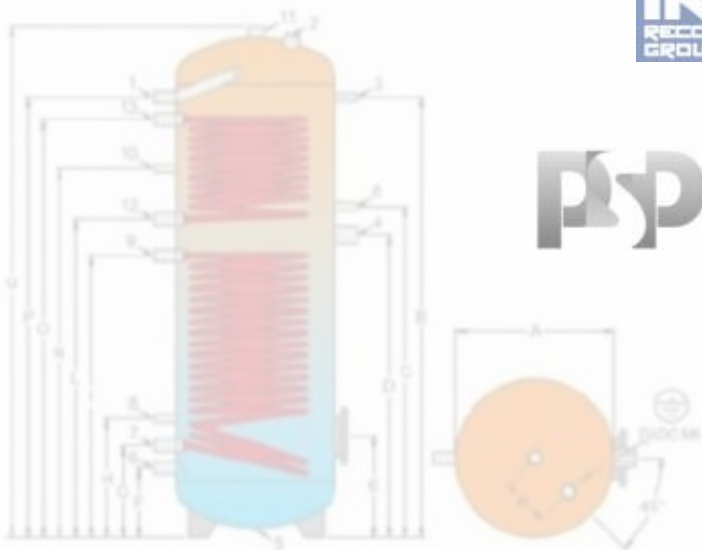

# TUBO SOLARE



# PANNELLI SOLARI

# L1 - SCALDABAGNI ELETTRICI ATLANTIC

## SCALDABAGNO ELETTRICO NANTO 5 ANNI

CODICE	DESCRIZIONE	CF	M.V.	PREZZO
09024 1002	10 litri sopra lavello	15	1	€ 151,40
09024 1001	10 litri sotto lavello	15	1	€ 158,00
09024 3000	30 litri	12	1	€ 194,20

- Fornito con cavo e spina.



## SCALDABAGNO ELETTRICO VERTICALE EGO

CODICE	DESCRIZIONE	CF	M.V.	PREZZO
09025 3000	30 litri	12	1	€ 183,33
09025 5000	50 litri	12	1	€ 204,16
09025 8000	80 litri	8	1	€ 208,33

- Fornito con cavo e spina.

- Garanzia 2 anni.



## SCALDABAGNO ELETTRICO ORIZZONTALE EGO

CODICE	DESCRIZIONE	CF	M.V.	PREZZO
09026 8000	80 litri orizzontale	8	1	€ 272,20



## SCALDABAGNO ELETTRICO GENIUS STEATITE WI-FI

CODICE	DESCRIZIONE	CF	M.V.	PREZZO
09029 0050	50 lt	1	1	€ 302,77
09029 0080	80 lt	1	1	€ 347,22

- Resistenza in steatite, protetta da una guaina vetrificata, non a contatto con l'acqua.

- Interfaccia digitale.

- Sistema automatico anti-legionella.

- Anodo di magnesio.

- Giunto dielettrico fornito di serie.

**New**



# L1 - SCALDABAGNI ELETTRICI CHAFFOTEAUX



## SCALDABAGNO ELETTRICO 2 ANNI

CODICE	DESCRIZIONE	RIF.	CF	M.V.	PREZZO
09400 1002	10 litri sopra lavello	3100372	1	1	€ 159,14
09400 1001	10 litri sotto lavello	3100377	1	1	€ 159,14
09400 3000	30 litri	3100385	30	1	€ 191,40



## SCALDABAGNO ELETTRICO VERTICALE 2 ANNI

CODICE	DESCRIZIONE	RIF.	CF	M.V.	PREZZO
09406 5000	50 litri	3201152	24	1	€ 208,33
09406 8000	80 litri	3201153	18	1	€ 214,50



## SCALDABAGNO ELETTRICO ORIZZONTALE 2 ANNI

CODICE	DESCRIZIONE	RIF.	CF	M.V.	PREZZO
09408 0000	80 litri H sx	3201236	1	1	€ 306,45



## CODOLO OTTONE CROMATO CURVO PER SCALDABAGNO

CODICE	DESCRIZIONE	CF	M.V.	PREZZO
05317 0404	1/2 x 1/2	1	1	€ 7,90
05317 0504	3/4 x 1/2	1	1	€ 6,75



## VALVOLA SICUREZZA SCALDABAGNO C/LEVETTA

CODICE	DESCRIZIONE	CF	M.V.	PREZZO
09420 0000	½ MF	10	1	€ 6,00



## VALVOLA SICUREZZA SCALDABAGNO TIPO PESANTE

CODICE	DESCRIZIONE	CF	M.V.	PREZZO
09422 0000	½	10	1	€ 13,23



## L2 - RESISTENZE SCALDABAGNI



### RESISTENZA DRITTA

CODICE	DESCRIZIONE	CF	M.V.	PREZZO
09430 0000	1200 W	1	1	€ 15,85



### RESISTENZA FLANGIATA FASTOM LUNGHI

CODICE	DESCRIZIONE	CF	M.V.	PREZZO
09432 0000	1200 W	1	1	€ 16,60



### RESISTENZA A VITE

CODICE	DESCRIZIONE	CF	M.V.	PREZZO
09434 0000	1200 W	1	1	€ 17,90



### RESISTENZA FLANGIATA CURVA

CODICE	DESCRIZIONE	CF	M.V.	PREZZO
09436 0000	1200 W	1	1	€ 20,48



## RESISTENZA FLANGIATA FASTOM LUNGI CURVA

CODICE	DESCRIZIONE	CF	M.V.	PREZZO
09438 0000	1200 W	1	1	€ 18,70



## RESISTENZA A VITE CURVA

CODICE	DESCRIZIONE	CF	M.V.	PREZZO
09440 0000	1200 W	1	1	€ 18,09



## RESISTENZA SCALDABAGNO 10-30 LT

CODICE	DESCRIZIONE	CF	M.V.	PREZZO
09442 0000	1200 W	1	1	€ 33,00



## RESISTENZA INOX C/PORTA ANODO

CODICE	DESCRIZIONE	CF	M.V.	PREZZO
09444 0000	1500 W	1	1	€ 35,13

- Per scaldabagni Thermex Hit e Hit ECO.



## RESISTENZA INOX C/PORTA ANODO AQUAVERSO

CODICE	DESCRIZIONE	CF	M.V.	PREZZO
09445 0000	1500 W	1	1	€ 35,13

- Per scaldabagni Aquaverso 50-80 lt.



## L3 - TERMOSTATI SCALDABAGNI



### TERMOSTATO SCALDABAGNO

CODICE	DESCRIZIONE	CF	M.V.	PREZZO
09450 0000	cm 30	1	1	€ 8,55



### TERMOSTATO SCALDABAGNO

CODICE	DESCRIZIONE	CF	M.V.	PREZZO
09452 0000	cm 30 doppia sicurezza	1	1	€ 13,15



### TERMOSTATO CON REGOLAZIONE ESTERNA

CODICE	DESCRIZIONE	CF	M.V.	PREZZO
09454 0000	Per tutti i modelli Thermex	1	1	€ 28,00

- Asta cm 27.



### ANODO DI MAGNESIO

CODICE	DESCRIZIONE	CF	M.V.	PREZZO
09458 0000	Per tutti i modelli Thermex	1	1	€ 9,91

- Champion e Champion eco.

## FLANGIA

CODICE	DESCRIZIONE	CF	M.V.	PREZZO
09460 0000	Per tutti i modelli Thermex	1	1	€ 10,13



## GUARNIZIONE FLANGIA

CODICE	DESCRIZIONE	CF	M.V.	PREZZO
09462 0000	Integrale a 5 buchi	1	1	€ 4,44



## GUARNIZIONE SCALDABAGNO

CODICE	DESCRIZIONE	CF	M.V.	PREZZO
09463 0000	5 fori	10	1	€ 4,44



## GUARNIZIONE PER RESISTENZA SCALDABAGNO

CODICE	DESCRIZIONE	CF	M.V.	PREZZO
09464 0000	--	1	1	€ 0,40



## GUARNIZIONE PER RESISTENZA OVALE

CODICE	DESCRIZIONE	CF	M.V.	PREZZO
09466 0000	10 - 30 LT	1	1	€ 2,68
09466 5080	50 - 80 LT	1	1	€ 2,68



# L5 - SCALDABAGNI A GAS INNOVITA



## SCALDINO CAMERA APERTA PRIMO LT 11 INNOVITA

CODICE	DESCRIZIONE	CF	M.V.	PREZZO
09300 1101	11 lt GPL	1	1	€ 389,00
09300 1102	11 lt MTN	1	1	€ 389,00



## SCALDINO CAMERA APERTA PRIMO LT 14 INNOVITA

CODICE	DESCRIZIONE	CF	M.V.	PREZZO
09300 1401	14 lt GPL	1	1	€ 472,50
09300 1402	14 lt MTN	1	1	€ 472,50



## SCALDABAGNO CAMERA STAGNA AMALFI HM INNOVITA

CODICE	DESCRIZIONE	CF	M.V.	PREZZO
09302 1101	11 lt GPL	1	1	€ 944,00
09302 1102	11 lt MTN	1	1	€ 944,00
09302 1401	14 lt GPL	1	1	€ 1.034,00
09302 1402	14 lt MTN	1	1	€ 1.034,00



## KIT FUMI PER SCALDABAGNO CAMERA STAGNA INNOVITA

CODICE	DESCRIZIONE	CF	M.V.	PREZZO
09308 0000	Kit coassiale	1	1	€ 80,49

# innovita



**TAAANTA ACQUA CALDA.  
FINO A 33 LITRI AL MINUTO.  
ISTANTANEA.**

**Akua è lo scaldabagno a  
condensazione Made in Italy che  
offre un **comfort senza limiti!****

- Ideale per grandi appartamenti e ville, hotel e b&b, parrucchieri, centri sportivi
- Altissima efficienza fino a 109%
- Modulazione fino a 1:10

UN'INTERA GAMMA  
DA **NON PERDERE**

- Caldaie
- Scaldabagni
- Pompe di calore
- Aria condizionata



[www.innovita.it](http://www.innovita.it)



## ESALATORE

CODICE	DESCRIZIONE	CF	M.V.	PREZZO
09232 0120	Ø 120	1	1	€ 27,75
09232 0130	Ø 130	1	1	€ 27,75
09232 0140	Ø 140	1	1	€ 29,20



## COPRICALDAIA E COPRISCALDABAGNO

CODICE	DESCRIZIONE	CF	M.V.	PREZZO
09240 0085	85x50x35	1	1	€ 93,60
09240 0102	102x55x45	1	1	€ 105,00



## VASO ESPANSIONE PLASTICA CIELO APERTO

CODICE	DESCRIZIONE	CF	M.V.	PREZZO
09241 0000	Lt 30	1	1	€ 44,50

## CIRCOLATORE XP 25-70

CODICE	DESCRIZIONE	CF	M.V.	PREZZO
09482 2513	Int. 130 - 1"-1/2	1	1	€ 137,50

- Dotato di selettore per modificare diverse velocità di regime della pompa in funzione dell'effettiva portata richiesta.
- Funzionamento da -10°C a + 110°C - IP44 - Cl. isolamento F.



## CIRCOLATORE XP 32-80

CODICE	DESCRIZIONE	CF	M.V.	PREZZO
09483 8018	Int. 180 - 2"	1	1	€ 245,00

- Dotato di selettore per modificare diverse velocità di regime della pompa in funzione dell'effettiva portata richiesta.
- Funzionamento da -10°C a + 110°C - IP44 - Cl. isolamento F.



## CIRCOLATORE MATRA

CODICE	DESCRIZIONE	CF	M.V.	PREZZO
09480 6018	A25/60 - 180 - 1"-1/2	1	1	€ 265,50
09480 8018	A25/80 - 180 - 1"-1/2	1	1	€ 385,00



## KIT BOCCHETTONI PER CIRCOLATORE

CODICE	DESCRIZIONE	CF	M.V.	PREZZO
09484 0705	1-1/4 x 3/4	1	1	€ 10,00
09484 0806	1-1/2 x 1"	1	1	€ 10,00
09484 0907	2" x 1-1/4	1	1	€ 16,00

- Il prezzo si riferisce alla coppia.



# L7 - CIRCOLATORI E GRUPPI RIEMPIMENTO

**New**



**X-POWER**

## CIRCOLATORE SANITARIO PROGRAMMABILE SANYPUMP

CODICE	DESCRIZIONE	CF	M.V.	PREZZO
09481 2060	1-1/2 - H6 mt; mc/h 4,2	1	1	€ 302,60

Sanyump è idoneo al ricircolo di acqua per consumo sanitario. Nel display sono impostabili le temperature di lavoro, si evita l'installazione di termostato.

- Pressione sonora max 8 db.
- Inclusi bocchettoni.



**X-POWER**

## MINIBOX - INVERTER - SILENZIOSO

CODICE	DESCRIZIONE	CF	M.V.	PREZZO
08720 0400	½ 2,8 bar	1	1	€ 325,00
08720 0500	kit trasduttore	1	1	€ 76,28

- Ideale sia per aumentare la pressione idrica dell'impianto, sia per essere utilizzato come circolatore sanitario; con l'aggiunta del kit trasduttore lavora a pressione costante.



**GIACOMINI**  
WATER MOTION

## GRUPPO DI RIEMPIMENTO Pn 10 CON MANOMETRO

CODICE	DESCRIZIONE	CF	M.V.	PREZZO
09488 0000	MF ½	10	1	€ 112,35

- Taratura 0,5 : 4 bar
- Completo di manometro



**APM**

## GRUPPO DI RIEMPIMENTO SENZA MANOMETRO

CODICE	DESCRIZIONE	CF	M.V.	PREZZO
09489 0000	MF ½	1	1	€ 46,00

## TERMOSTATO A CONTATTO

CODICE	DESCRIZIONE	CF	M.V.	PREZZO
09470 0000	20/90°	1	1	€ 26,60



## TERMOSTATO AD IMMERSIONE

CODICE	DESCRIZIONE	CF	M.V.	PREZZO
09472 0000	30/90°	1	1	€ 37,70



## TERMOSTATO A CAPILLARE CTR

CODICE	DESCRIZIONE	CF	M.V.	PREZZO
09474 0000	30/90°	1	1	€ 32,50

- Completo di ghiera e manopola.



## POZZETTO 1/2" PER TERMOSTATO

CODICE	DESCRIZIONE	CF	M.V.	PREZZO
09476 0000	cm 10	1	1	€ 9,76





**ICMA**

## VALVOLA DI SICUREZZA MF 1/2

CODICE	DESCRIZIONE	CF	M.V.	PREZZO
09490 0025	2,5 bar	50	1	€ 9,75
09490 0030	3,0 bar	50	1	€ 9,75
09490 0035	3,5 bar	50	1	€ 9,75
09490 0040	4,0 bar	50	1	€ 9,75
09490 0045	4,5 bar	50	1	€ 9,75
09490 0060	6,0 bar	50	1	€ 11,20
09490 0080	8,0 bar	50	1	€ 12,60



**TECNOGAS**

## VALVOLA DI SICUREZZA OMOLOGATA INAIL 2,5 BAR

CODICE	DESCRIZIONE	CF	M.V.	PREZZO
09496 0405	1/2 x 3/4	1	1	€ 97,50
09496 0506	3/4 x 1"	1	1	€ 130,00
09496 0607	1" x 1-1/4	1	1	€ 258,00

**New**



## VALVOLA SCARICO TERMICO C/REINTEGRO

CODICE	DESCRIZIONE	CF	M.V.	PREZZO
09498 0500	3/4	10	1	€ 130,00

- Previene il surriscaldamento di generatori termici.  
A raggiungimento della temperatura a 95 °C la valvola si apre permettendo lo scarico dell'acqua calda in eccesso e l'ingresso d'acqua fredda nella caldaia.



## VALVOLA DI SICUREZZA PER SOLARE

CODICE	DESCRIZIONE	CF	M.V.	PREZZO
09500 0060	6 bar	1	1	€ 19,00

## VALVOLA MISCELATRICE HYDROMARK

CODICE	DESCRIZIONE	CF	M.V.	PREZZO
09510 0000	1" x 3/4	25	1	€ 127,22

- Con bocchettoni MMM



## VALVOLA MISCELATRICE TERMOSTATICA PER SOLARE

CODICE	DESCRIZIONE	CF	M.V.	PREZZO
09512 0000	3/4 c/bocchettoni	10	1	€ 196,00



## VALVOLA MISCELATRICE TERMOSTATICA PER SOLARE

CODICE	DESCRIZIONE	CF	M.V.	PREZZO
09514 0605	1" x 3/4	10	1	€ 135,00



## VALVOLA DEVIATRICE PER SOLARE

CODICE	DESCRIZIONE	CF	M.V.	PREZZO
09516 0500	Termostatica 3/4	1	1	€ 199,00





## GRUPPO KIT INTEGRAZIONE SOLARE CALDAIA

CODICE	DESCRIZIONE	CF	M.V.	PREZZO
09520 0000	Deviatrice 45° + miscelatrice 30/60°	1	1	€ 284,00



## TES ALLACCIAMENTO SOLARE

CODICE	DESCRIZIONE	CF	M.V.	PREZZO
09524 0000	1"	1	1	€ 55,00

- Con portasonda e valvola di sfiato.



## CENTRALINA PER KIT FORZATO CON DUE USCITE

CODICE	DESCRIZIONE	CF	M.V.	PREZZO
09530 0000	Analogica	1	1	€ 180,00



## GRUPPO CIRCOLAZIONE ELETTRONICO

CODICE	DESCRIZIONE	CF	M.V.	PREZZO
09532 0001	Wilo	1	1	€ 631,58



## COLLETTORE SOLARE

CODICE	DESCRIZIONE	CF	M.V.	PREZZO
09534 0025	mq 2,5* - 1230 x 1980	1	1	€ 853,13
09534 0027	mq 2,75** - 1230 x 2250	1	1	€ 931,88

\*mq 2,5: conto termico 907,00

\*\*mq 2,75: conto termico 1.060,00



## TELAIO PER COLLETTORI SOLARI

CODICE	DESCRIZIONE	CF	M.V.	PREZZO
09535 0000	Tetto piano e inclinato	1	1	€ 380,63

- Adattabile per 1 oppure 2 collettori.



## ALIGEL HC30 BIO - ad alta concentrazione

CODICE	DESCRIZIONE	CF	M.V.	PREZZO
09539 0000	lt 5	4	1	€ 51,13

- Fluido termovettore anticongelante, anticorrosivo a base di glicole monopropilenico biodegradabile. Prestazioni elevate, resistente da -32° a +160°C (5 bar), con rilevatore di perdite fluorescente.



## GLICOLE PURO ALIGEL

CODICE	DESCRIZIONE	CF	M.V.	PREZZO
09538 0000	5 lt.	4	1	€ 64,50

- Puro, da diluire.





## KIT SOLARE TERMICO NATURALE LT 300

CODICE	DESCRIZIONE	CF	M.V.	PREZZO
09536 0300	300 lt	1	1	€ 3.500,00

- Bollitore lt 300.
- 2 pannelli da 2,9 mq.
- Staffaggio.
- Glicole e kit raccordi di collegamento.
- Incentivo GSE netto € 2.080,00.



## STAFFA PER VASO ESPANSIONE

CODICE	DESCRIZIONE	CF	M.V.	PREZZO
09012 0400	3/4	1	1	€ 46,25



## VASO ESPANSIONE SANITARIO/RISCALDAMENTO

CODICE	DESCRIZIONE	CF	M.V.	PREZZO
09548 0200	Litri 2	4	1	€ 49,00
09548 0500	Litri 5	2	1	€ 56,00
09548 0800	Litri 8	1	1	€ 63,00
09548 1200	Litri 12	1	1	€ 70,50
09548 1800	Litri 18	1	1	€ 76,50
09548 2400	Litri 24	1	1	€ 84,00



## VASO ESPANSIONE PER SOLARE

CODICE	DESCRIZIONE	CF	M.V.	PREZZO
09549 1200	Litri 12	1	1	€ 77,00
09549 1800	Litri 18	1	1	€ 88,30
09549 2500	Litri 25	1	1	€ 99,00

# Vertigo Steatite Wi-Fi WaterDrop

Intelligente, elegante e salva-spazio lo Scaldabagno Elettrico che ti garantisce il comfort ottimale per l'acqua calda



SERVIZIO GESTIONE GARANZIA  
5 ANNI DI GARANZIA  
**atlantic**  
Excellence



Cozytouch

## Modelli da 50 a 100 L

• Connettività Wi-Fi CozyTouch

## + VANTAGGI

- Equipaggiato di serie con cavo e spina, valvola di sicurezza 8 bar e giunto dielettrico
- Elementi riscaldanti in Steatite protetti da una guaina vetrificata per limitare le incrostazioni e facilitare la manutenzione
- Interfaccia digitale ed ergonomica "WaterDrop" con indicatore di riscaldamento, modalità di funzionamento e connettività & controllo remoto tramite l'applicazione Cozytouch
- Design ultrapiatto per soluzioni salvaspazio (profondità inferiore a 30 cm), installazione orizzontale e verticale
- Risparmio energetico: modalità Eco+, modalità assenza, monitoraggio consumo elettricità
- Sistema automatico trattamento antilegionella

### EQUIPAGGIAMENTO

- Smart control: sistema per il risparmio energetico e controllo dei consumi
- Funzione Boost: 1 doccia in meno di 30 minuti
- Tecnologia Steatite a doppio serbatoio: Doppio elemento riscaldante a secco in ceramica
- Termostato elettronico
- Isolamento ad alta densità senza CFC
- Protezione con anodo al magnesio
- Smaltatura Diamond Quality
- Valvola di sicurezza 8 bar
- Flangia di ispezione
- Facile installazione con staffe a muro e dima di montaggio
- Indicatore di riscaldamento "Waterdrop"
- Cavo e spina forniti di serie
- Giunto dielettrico fornito di serie

### CONNETTIVITÀ WI-FI

- Controllo remoto tramite l'applicazione Cozytouch
- Selezione modalità rapida: Manuale / Eco + / Boost / Assenza
- Monitoraggio del consumo di acqua ed elettricità
- Avviso mancanza acqua calda
- Tempo rimanente prima che la prossima doccia sia pronta

- 1 Smaltatura DIAMOND QUALITY
- 2 Isolamento poliuretano ad alta densità 0% CFC
- 3 Anodo al magnesio
- 4 Doppia resistenza immersa in steatite
- 5 Ingresso acqua
- 6 Tubo uscita ottimizzato in acciaio inox
- 7 Interfaccia digitale WaterDrop



**Steatite technology**  
resistenza elettrica in ceramica non a contatto con l'acqua, permette di ispezionare la resistenza senza svuotare l'accumulo

**Steatite**  
TECHNOLOGY

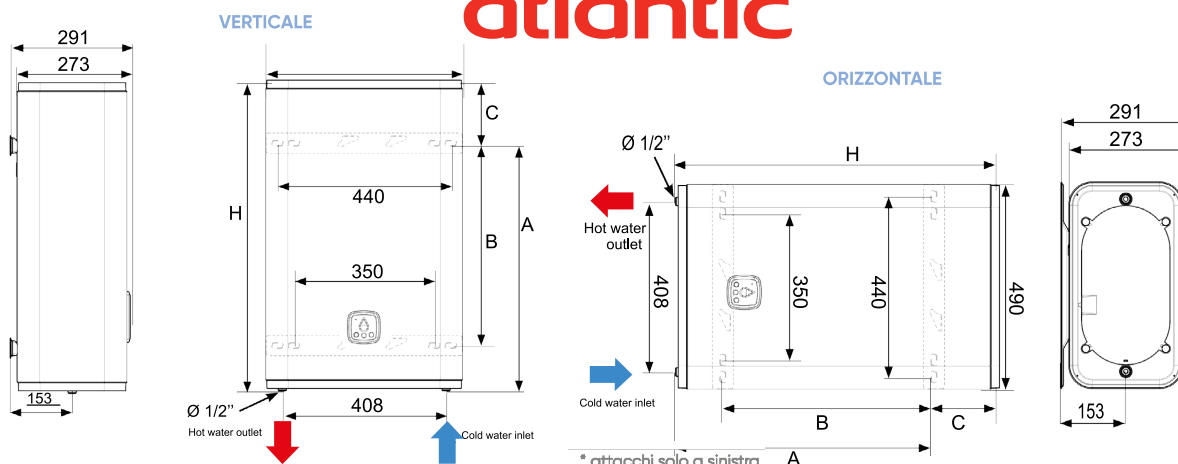

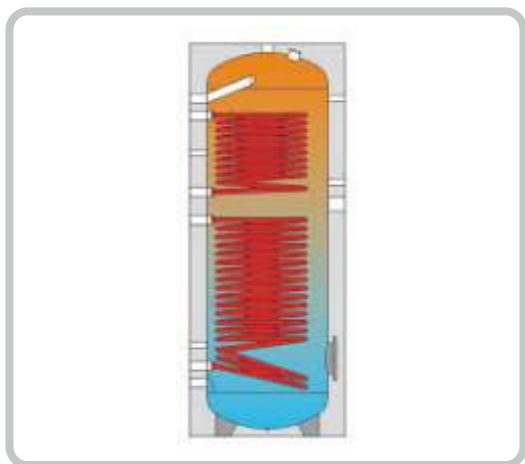

## BOLLITORE AQUA 2 BP

CODICE	DESCRIZIONE	CF	M.V.	PREZZO
09542 0300	LT 300 DM 500 x H 1615	1	1	€ 1.810,00
09542 0500	LT 500 DM 650 x H 1705	1	1	€ 2.590,00
09542 1000	LT 1000 DM 790 x H 2205	1	1	€ 4.650,00

- 2 serpentine in acciaio al carbonio, completo di anodo.
- Isolamento poliuretano rigido 50 mm.
- Pressione massima esercizio 10 bar.
- Temperatura massima esercizio 95°C.



## SCALDABAGNO IN POMPA DI CALORE CALYPSO VM

CODICE	DESCRIZIONE	CF	M.V.	PREZZO
09581 0100	100 lt	1	1	€ 2.150,00

- Canalizzabile
- Installazione murale
- Basso livello di rumorosità
- Comando a distanza tramite app
- Resistenza in steatite 1200 W non a contatto con l'acqua
- Anodo di magnesio + anodo elettronico
- Incentivo GSE € 400,00
- Valvola sicurezza 8bar fornita di serie
- Giunto di elettrico incluso
- Tubo espulsione condensa incluso

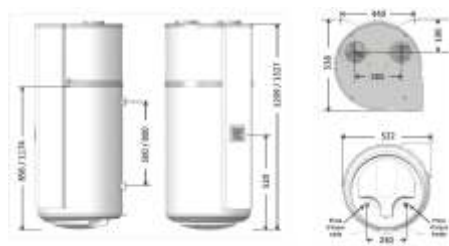

**New**

**atlantic**

## SCALDABAGNO IN POMPA DI CALORE EXPLORER R290

CODICE	DESCRIZIONE	CF	M.V.	PREZZO
09583 0200	Litri 200	1	1	€ 4.122,00
09483 0270	Litri 270	1	1	€ 4.310,00

- Gas R290
- Wi-Fi integrato
- Bassa rumorosità
- Compatibilità con impianto fotovoltaico
- Resistenza elettrica in acciaio Inox con protezione anodo di Magnesio + anodo elettronico.
- Con serpentina ausiliaria per collegamento ad altra fonte di energia o per ricircolo ACS
- Canalizzabile.



## PUFFER INERZIALE

CODICE	DESCRIZIONE	CF	M.V.	PREZZO
09544 0050	Litri 50	1	1	€ 590,00
09544 0100	Litri 100	1	1	€ 742,00



## TUBO SOLARE CON ISOLAMENTO MM 13 DN16

CODICE	DESCRIZIONE	CF	M.V.	PREZZO
09552 1610	DN 16 - DM 20 - MT 10	1	1	€ 376,00
09552 1615	DN 16 - DM 20 - MT 15	1	1	€ 564,00
09552 1625	DN 16 - DM 20 - MT 25	1	1	€ 926,00



## TUBO SOLARE CON ISOLAMENTO MM 13 DN20

CODICE	DESCRIZIONE	€	M.V.	PREZZO
09554 2015	DN 20 - DM 25 - MT 15	1	1	€ 670,00
09554 2025	DN 20 - DM 25 - MT 25	1	1	€ 1.110,00



## RACCORDO SOLARE MASCHIO

CODICE	DESCRIZIONE	CF	M.V.	PREZZO
09558 1605	DN 16 x 3/4 M	1	1	€ 19,75
09558 2006	DN 20 x 1" M	1	1	€ 27,20



## RACCORDO SOLARE - TUBO RAME

CODICE	DESCRIZIONE	CF	M.V.	PREZZO
09559 1622	DN 16 x RAME 22	1	1	€ 21,50
09559 2022	DN 20 x RAME 22	1	1	€ 30,50



# L14 - RACCORDI RAME PER SOLARE



## MANICOTTO MASCHIO PER TUBO RAME CON OGIVA IN OTTONE

CODICE	DESCRIZIONE	CF	M.V.	PREZZO
09560 1805	3/4 x 18	10	1	€ 6,47
09560 2205	3/4 x 22	5	1	€ 7,10



## MANICOTTO FEMMINA PER TUBO RAME CON OGIVA IN OTTONE

CODICE	DESCRIZIONE	CF	M.V.	PREZZO
09562 1805	3/4 x 18	10	1	€ 7,10
09562 2205	3/4 x 22	5	1	€ 7,10

- Con portasonda e valvola di sfiato.



## MANICOTTO DRITTO DOPPIO CON OGIVA IN OTTONE

CODICE	DESCRIZIONE	CF	M.V.	PREZZO
09564 1818	18 x 18	5	1	€ 10,00
09564 2222	22 x 22	5	1	€ 10,00



## TAPPO CON OGIVA IN OTTONE

CODICE	DESCRIZIONE	CF	M.V.	PREZZO
09566 1800	Ø 18	1	1	€ 4,80
09566 2200	Ø 22	1	1	€ 5,80

# CANNE FUMARIE

- Acciaio nero

- Coassiale

- PPS

- Acciaio monoparete

- Acciaio doppia pareete

*Io questa vita me la sono inventata.  
Ognuno lo può fare, ci vuole solo  
coraggio e determinazione.*

*Tiziano Terzani*

# CANNE FUMARIE

- Alluminio

- PPS

- Acciaio



# CANNE FUMARIE



# M1 - CANNE FUMARIE IN ACCIAIO INOX NERO TEFLONATA

## ELEMENTO DIRITTO L:1000 mm

CODICE	DESCRIZIONE	CF	M.V.	PREZZO
20040 0080	80	20	1	€ 35,50



## ELEMENTO DIRITTO L:500 mm

CODICE	DESCRIZIONE	CF	M.V.	PREZZO
20042 0080	80	12	1	€ 27,60



## ELEMENTO DIRITTO L: 250 mm

CODICE	DESCRIZIONE	CF	M.V.	PREZZO
20043 0080	80	12	1	€ 17,00



## CURVA A 45°

CODICE	DESCRIZIONE	CF	M.V.	PREZZO
20044 0080	80	10	1	€ 25,50



# M1 - CANNE FUMARIE IN ACCIAIO INOX NERO TEFLONATA



## CURVA A 90°

CODICE	DESCRIZIONE	CF	M.V.	PREZZO
20046 0080	80	10	1	€ 32,55



## TEEES FMM

CODICE	DESCRIZIONE	CF	M.V.	PREZZO
20050 0080	80	6	1	€ 42,50



## MANICOTTO FF

CODICE	DESCRIZIONE	CF	M.V.	PREZZO
20056 0080	80	4	1	€ 21,20



## TAPPO

CODICE	DESCRIZIONE	CF	M.V.	PREZZO
20054 0080	80	12	1	€ 33,50



## ROSONE

CODICE	DESCRIZIONE	CF	M.V.	PREZZO
20032 0080	80	10	1	€ 17,75

## M2 - CANNE FUMARIE IN ACCIAIO NERO AL CARBONIO

### ELEMENTO DIRITTO L:1000 mm LINEA FERTEC SP 2mm

CODICE	DESCRIZIONE	CF	M.V.	PREZZO
20060 0130	130	1	1	€ 81,90
20060 0150	150	1	1	€ 85,00



### ELEMENTO DIRITTO L:500 mm LINEA FERTEC SP 2mm

CODICE	DESCRIZIONE	CF	M.V.	PREZZO
20062 0130	130	1	1	€ 47,80
20062 0150	150	1	1	€ 54,00



### ELEMENTO DIRITTO L: 250 mm LINEA FERTEC SP 2mm

CODICE	DESCRIZIONE	CF	M.V.	PREZZO
20063 0130	130	1	1	€ 35,50
20063 0150	150	1	1	€ 38,30



### CURVA A 90° LINEA FERTEC SP 2mm

CODICE	DESCRIZIONE	CF	M.V.	PREZZO
20064 0130	130 - H181 - A131	1	1	€ 81,90
20064 0150	150 - H191 - A141	1	1	€ 91,40

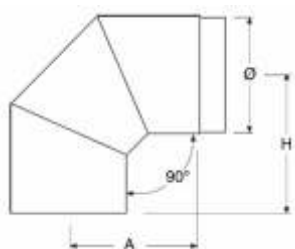

# M2 - CANNE FUMARIE IN ACCIAIO NERO AL CARBONIO



## CURVA A 45° LINEA FERTEC SP 2mm

CODICE	DESCRIZIONE	CF	M.V.	PREZZO
20066 0130	130 - H145 - A75	1	1	€ 64,00
20066 0150	150 - H154 - A78	1	1	€ 69,30

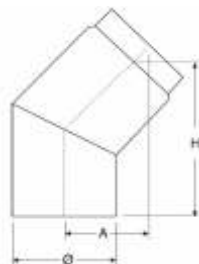

## RIDUZIONE FM 130/120 LINEA FERTEC SP 2mm

CODICE	DESCRIZIONE	CF	M.V.	PREZZO
20068 1312	130/120	1	1	€ 85,00



## ROSONE LINEA FERTEC SP 2mm

CODICE	DESCRIZIONE	CF	M.V.	PREZZO
20070 0130	130	1	1	€ 29,40
20070 0150	150	1	1	€ 29,40

# M3 - FUMISTERIA COASSIALE PER CALDAIE A CONDENSAZIONE

## PROLUNGA COASSIALE PER LINEA CONDENSAZIONE

CODICE	DESCRIZIONE	CF	M.V.	PREZZO
20100 0025	25 cm	1	1	€ 22,60
20100 0050	50 cm	1	1	€ 32,40
20100 0100	100 cm	1	1	€ 43,00



## CURVA APERTA COASSIALE PER LINEA CONDENSAZIONE

CODICE	DESCRIZIONE	CF	M.V.	PREZZO
20102 0000	60-100	1	1	€ 42,35



## CURVA CHIUSA COASSIALE PER LINEA CONDENSAZIONE

CODICE	DESCRIZIONE	CF	M.V.	PREZZO
20104 0000	60-100	1	1	€ 45,00



## KIT FUMI COASSIALE PER CALDAIA A CONDENSAZIONE

CODICE	DESCRIZIONE	CF	M.V.	PREZZO
20098 0000	60-100	1	1	€ 60,00

- Adatto per 40 marche di caldaie, tra cui:  
Arco, Argo, Ariston, AR Therm, Baltur, Baxi, Beretta, Biasi,  
Bongioanni, Euroterm, Ferroli, Fondital, Fontecal, Innovita,  
Italtherm, Joannes, Radiant, Riello, Rinnai (Zen),  
Saunier Duval (Themis), Savio, Simat, Sime, Sylber,  
Thermital, Unical (Nox; Nox +), Vaillant, Viesman,  
Chaffoteaux, Daikin.



# M4 - FUMISTERIA IN PPS PER CALDAIA A CONDENSAZIONE



## TUBO PPS Ø 60 LINEA CONDENSAZIONE

CODICE	DESCRIZIONE	CF	M.V.	PREZZO
20111 0050	cm 50	1	1	€ 6,60
20111 0100	cm 100	1	1	€ 10,00



## CURVA PPS Ø 60 LINEA CONDENSAZIONE

CODICE	DESCRIZIONE	CF	M.V.	PREZZO
20115 0000	90° Ø 60 MF	1	1	€ 6,85



## CURVA PPS Ø 60 LINEA CONDENSAZIONE

CODICE	DESCRIZIONE	CF	M.V.	PREZZO
20113 0000	45° Ø 60 MF	1	1	€ 6,60

# M4 - FUMISTERIA IN PPS PER CALDAIE A CONDENSAZIONE

## TUBO PPS Ø 80 LINEA CONDENSAZIONE

CODICE	DESCRIZIONE	CF	M.V.	PREZZO
20110 0025	CM 25	1	1	€ 6,00
20110 0050	CM 50	1	1	€ 6,75
20110 0100	CM 100	1	1	€ 10,25
20110 0200	CM 200	1	1	€ 21,40



## CURVA PPS Ø 80 LINEA CONDENSAZIONE

CODICE	DESCRIZIONE	CF	M.V.	PREZZO
20114 0000	90° Ø 80 MF	10	1	€ 6,98



## CURVA PPS Ø 80 LINEA CONDENSAZIONE

CODICE	DESCRIZIONE	CF	M.V.	PREZZO
20112 0000	45° Ø 80 MF	10	1	€ 6,75



## TES RACCOGLI CONDENSA PPS

CODICE	DESCRIZIONE	Misura	CF	M.V.	PREZZO
20116 0000	TES F-M-M	Ø 80	1	1	€ 12,80



# M4 - FUMISTERIA IN PPS PER CALDAIE A CONDENSAZIONE



## TAPPO RACCOGLI CONDENSA PPS

CODICE	DESCRIZIONE	Misura	CF	M.V.	PREZZO
20118 0000	TAPPO	Ø 80 x ½	1	1	€ 7,70

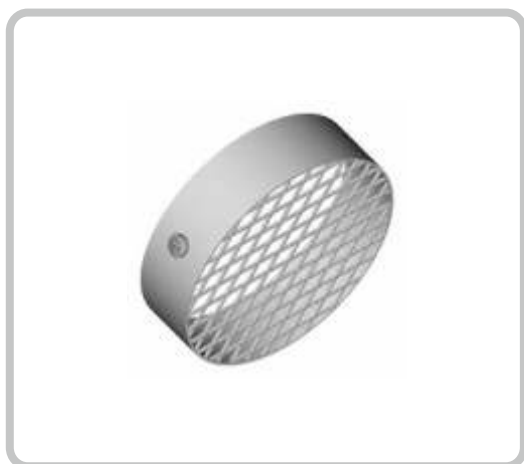

## GRIGLIA ASPIRAZIONE IN NYLON

CODICE	DESCRIZIONE	CF	M.V.	PREZZO
20120 0000	Ø 80	10	1	€ 7,80



## GRIGLIA SCARICO FUMI IN NYLON

CODICE	DESCRIZIONE	CF	M.V.	PREZZO
20122 0000	Ø 80	1	1	€ 7,90



## RIDUZIONE PPS

CODICE	DESCRIZIONE	CF	M.V.	PREZZO
20124 8060	80F x 60M	1	1	€ 27,50
20124 1080	100F x 80M	1	1	€ 30,80

# M4 - FUMISTERIA IN PPS PER CALDAIE A CONDENSAZIONE

## COLLARE REGGITUBO

CODICE	DESCRIZIONE	CF	M.V.	PREZZO
20126 0000	∅ 80 Bianco	2	2	€ 3,90



## COLLARE REGGITUBO

CODICE	DESCRIZIONE	CF	M.V.	PREZZO
20128 0000	∅ 80 Nero	2	2	€ 4,28



## ROSONE IN GOMMA

CODICE	DESCRIZIONE	CF	M.V.	PREZZO
20130 0060	dm 60	1	1	€ 4,15
20130 0080	dm 80	1	1	€ 4,22
20130 0100	dm 100	1	1	€ 4,62



## ROSONE INOX 316

CODICE	DESCRIZIONE	CF	M.V.	PREZZO
20132 0080	80	1	1	€ 17,20
20132 0100	100	1	1	€ 17,20
20132 0120	120	1	1	€ 22,00
20132 0130	130	1	1	€ 22,50
20132 0140	140	1	1	€ 22,50
20132 0150	150	1	1	€ 23,00
20132 0160	160	1	1	€ 23,20
20132 0180	180	1	1	€ 23,40
20132 0200	200	1	1	€ 33,30
20132 0250	250	1	1	€ 39,50



# M5 - FUMISTERIA COASSIALE PER CALDAIE A CONDENSAZIONE



## TUBO FLESSIBILE IN ALLUMINIO

CODICE	DESCRIZIONE	CF	M.V.	PREZZO
20109 0080	80	1	1	€ 17,10
20109 0100	100	1	1	€ 18,40
20109 0120	120	1	1	€ 21,85
20109 0130	130	1	1	€ 29,34
20109 0140	140	1	1	€ 30,28
20109 0150	150	1	1	€ 30,97
20109 0160	160	1	1	€ 33,52
20109 0180	180	1	1	€ 36,96
20109 0200	200	1	1	€ 39,97
20109 0250	250	1	1	€ 57,96

# M6 - CANNE FUMARIE IN ACCIAIO MONOPARETE

## ELEMENTO DIRITTO L:1000mm

CODICE	DESCRIZIONE	CF	M.V.	PREZZO
20140 0080	80	1	1	€ 24,38
20140 0100	100	1	1	€ 28,39
20140 0120	120	1	1	€ 36,32
20140 0130	130	1	1	€ 39,23
20140 0140	140	1	1	€ 51,07
20140 0150	150	1	1	€ 40,78
20140 0160	160	1	1	€ 43,60
20140 0180	180	1	1	€ 51,63
20140 0200	200	1	1	€ 56,74
20140 0250	250	1	1	€ 62,57
20140 0300	300	1	1	€ 74,07



## ELEMENTO DIRITTO L:500 mm

CODICE	DESCRIZIONE	CF	M.V.	PREZZO
20142 0080	80	1	1	€ 19,14
20142 0100	100	1	1	€ 19,80
20142 0120	120	1	1	€ 22,64
20142 0130	130	1	1	€ 24,78
20142 0140	140	1	1	€ 26,69
20142 0150	150	1	1	€ 27,82
20142 0160	160	1	1	€ 29,53
20142 0180	180	1	1	€ 32,02
20142 0200	200	1	1	€ 33,70
20142 0250	250	1	1	€ 39,41
20142 0300	300	1	1	€ 46,73



## CURVA A 45°

CODICE	DESCRIZIONE	CF	M.V.	PREZZO
20144 0080	80	1	1	€ 17,94
20144 0100	100	1	1	€ 19,63
20144 0120	120	1	1	€ 24,49
20144 0130	130	1	1	€ 25,57
20144 0140	140	1	1	€ 26,80
20144 0150	150	1	1	€ 27,40
20144 0160	160	1	1	€ 29,21
20144 0180	180	1	1	€ 31,25
20144 0200	200	1	1	€ 34,53
20144 0250	250	1	1	€ 40,38
20144 0300	300	1	1	€ 67,77



## CURVA A 90°

CODICE	DESCRIZIONE	CF	M.V.	PREZZO
20146 0080	80	1	1	€ 28,39
20146 0100	100	1	1	€ 32,74
20146 0120	120	1	1	€ 34,94
20146 0130	130	1	1	€ 37,10
20146 0140	140	1	1	€ 39,74
20146 0150	150	1	1	€ 40,81
20146 0160	160	1	1	€ 43,00
20146 0180	180	1	1	€ 46,50
20146 0200	200	1	1	€ 48,60
20146 0250	250	1	1	€ 58,90
20146 0300	300	1	1	€ 71,54



# M6 - CANNE FUMARIE IN ACCIAIO MONOPARETE



## RACCORDO A TEE 135°

CODICE	DESCRIZIONE	CF	M.V.	PREZZO
20148 0080	80	1	1	€ 49,78
20148 0100	100	1	1	€ 55,34
20148 0120	120	1	1	€ 63,53
20148 0130	130	1	1	€ 66,57
20148 0140	140	1	1	€ 70,67
20148 0150	150	1	1	€ 74,03
20148 0160	160	1	1	€ 79,70
20148 0180	180	1	1	€ 82,95
20148 0200	200	1	1	€ 92,09
20148 0250	250	1	1	€ 110,25
20148 0300	300	1	1	€ 137,81



## RACCORDO A TEE 90°

CODICE	DESCRIZIONE	CF	M.V.	PREZZO
20150 0080	80	1	1	€ 40,64
20150 0100	100	1	1	€ 40,64
20150 0120	120	1	1	€ 43,58
20150 0130	130	1	1	€ 45,50
20150 0140	140	1	1	€ 47,13
20150 0150	150	1	1	€ 48,53
20150 0160	160	1	1	€ 50,02
20150 0180	180	1	1	€ 59,26
20150 0200	200	1	1	€ 61,72
20150 0250	250	1	1	€ 71,84
20150 0300	300	1	1	€ 82,37



## RACCORDO A TEE INOX F-F-M MONOPARETE

CODICE	DESCRIZIONE	CF	M.V.	PREZZO
20152 0080	80	1	1	€ 37,70
20152 0100	100	1	1	€ 40,57
20152 0130	130	1	1	€ 45,91
20152 0150	150	1	1	€ 51,80



## TAPPO CONDENSA INOX 316

CODICE	DESCRIZIONE	CF	M.V.	PREZZO
20154 0080	80	1	1	21,50
20154 0100	100	1	1	23,25
20154 0120	120	1	1	25,30
20154 0130	130	1	1	27,10
20154 0140	140	1	1	28,55
20154 0150	150	1	1	28,90
20154 0160	160	1	1	29,80
20154 0180	180	1	1	32,20
20154 0200	200	1	1	37,00
20154 0250	250	1	1	45,72
20154 0300	300	1	1	51,30

# M6 - CANNE FUMARIE IN ACCIAIO MONOPARETE

## TRONCHETTO INOX F/F

CODICE	DESCRIZIONE	CF	M.V.	PREZZO
20156 0080	80	1	1	€ 11,78
20156 0100	100	1	1	€ 12,92
20156 0120	120	1	1	€ 14,64
20156 0130	130	1	1	€ 15,87
20156 0140	140	1	1	€ 17,29
20156 0150	150	1	1	€ 17,93
20156 0160	160	1	1	€ 18,51
20156 0180	180	1	1	€ 20,59
20156 0200	200	1	1	€ 21,84
20156 0250	250	1	1	€ 25,20
20156 0300	300	1	1	€ 29,93



## TRONCHETTO INOX M/M

CODICE	DESCRIZIONE	CF	M.V.	PREZZO
20158 0080	80	1	1	€ 11,78
20158 0100	100	1	1	€ 12,92
20158 0120	120	1	1	€ 14,64
20158 0130	130	1	1	€ 15,86
20158 0140	140	1	1	€ 17,29
20158 0150	150	1	1	€ 17,93
20158 0160	160	1	1	€ 18,52
20158 0180	180	1	1	€ 20,59
20158 0200	200	1	1	€ 21,84
20158 0250	250	1	1	€ 25,17
20158 0300	300	1	1	€ 29,84



## RIDUZIONE MONOPARETE MF

CODICE	DESCRIZIONE	CF	M.V.	PREZZO
20160 0080	100M - 80F	1	1	€ 29,34
20160 0100	120M - 100F	1	1	€ 33,00
20160 0150	200M - 150F	1	1	€ 53,46



## RIDUZIONE MONOPARETE FM

CODICE	DESCRIZIONE	CF	M.V.	PREZZO
20162 0080	100F - 80M	1	1	€ 29,34
20162 0100	120F - 100M	1	1	€ 33,00
20162 0150	200F - 150M	1	1	€ 53,46



## RACCORDO CALDAIA FF

CODICE	DESCRIZIONE	CF	M.V.	PREZZO
20164 0810	80x100	1	1	€ 30,50
20164 1213	120x130	1	1	€ 30,50
20164 1314	130x140	1	1	€ 32,00
20164 1415	140x150	1	1	€ 32,00
20164 1516	150x160	1	1	€ 34,00
20164 1618	160x180	1	1	€ 36,00
20164 1820	180x200	1	1	€ 40,00
20164 2025	200x250	1	1	€ 45,00
20164 2530	250x300	1	1	€ 49,00



# M6 - CANNE FUMARIE IN ACCIAIO MONOPARETE



## ELEMENTO TELESCOPICO 255/360

CODICE	DESCRIZIONE	CF	M.V.	PREZZO
20168 0080	80	1	1	€ 26,25
20168 0100	100	1	1	€ 30,00
20168 0120	120	1	1	€ 34,30
20168 0130	130	1	1	€ 36,30
20168 0140	140	1	1	€ 39,00
20168 0150	150	1	1	€ 41,20
20168 0160	160	1	1	€ 43,50
20168 0180	180	1	1	€ 52,00
20168 0200	200	1	1	€ 52,00
20168 0250	250	1	1	€ 64,80
20168 0300	300	1	1	€ 79,80



## CAPPELLO EOLICO

CODICE	DESCRIZIONE	CF	M.V.	PREZZO
20170 0080	80	1	1	€ 68,70
20170 0100	100	1	1	€ 68,70
20170 0120	120	1	1	€ 68,70
20170 0130	130	1	1	€ 73,80
20170 0140	140	1	1	€ 74,40
20170 0150	150	1	1	€ 74,40
20170 0160	160	1	1	€ 82,30
20170 0180	180	1	1	€ 85,20
20170 0200	200	1	1	€ 88,00
20170 0250	250	1	1	€ 99,70
20170 0300	300	1	1	€ 105,50



## CAPPELLO CINESE

CODICE	DESCRIZIONE	CF	M.V.	PREZZO
20172 0080	80	1	1	€ 26,30
20172 0100	100	1	1	€ 32,00
20172 0120	120	1	1	€ 32,00
20172 0130	130	1	1	€ 32,00
20172 0140	140	1	1	€ 32,00
20172 0150	150	1	1	€ 32,00
20172 0160	160	1	1	€ 40,00
20172 0180	180	1	1	€ 40,00
20172 0200	200	1	1	€ 44,00
20172 0250	250	1	1	€ 51,00
20172 0300	300	1	1	€ 57,80



## CAPPELLO ANTIRIFLUSSO

CODICE	DESCRIZIONE	CF	M.V.	PREZZO
20174 0080	80	1	1	€ 38,70
20174 0100	100	1	1	€ 39,70
20174 0120	120	1	1	€ 59,60
20174 0130	130	1	1	€ 47,80
20174 0140	140	1	1	€ 50,20
20174 0150	150	1	1	€ 51,80
20174 0160	160	1	1	€ 52,70
20174 0180	180	1	1	€ 59,60
20174 0200	200	1	1	€ 62,20
20174 0250	250	1	1	€ 68,00
20174 0300	300	1	1	€ 75,00

## GUARNIZIONE SILICONATA

CODICE	DESCRIZIONE	CF	M.V.	PREZZO
20182 0080	80	10	1	€ 1,07
20182 0100	100	10	1	€ 1,30
20182 0120	120	10	1	€ 2,30
20182 0130	130	10	1	€ 2,30
20182 0140	140	10	1	€ 2,80
20182 0150	150	10	1	€ 3,10
20182 0160	160	10	1	€ 3,35
20182 0180	180	10	1	€ 3,70
20182 0200	200	10	1	€ 6,40
20182 0250	250	10	1	€ 6,60
20182 0300	300	10	1	€ 7,40

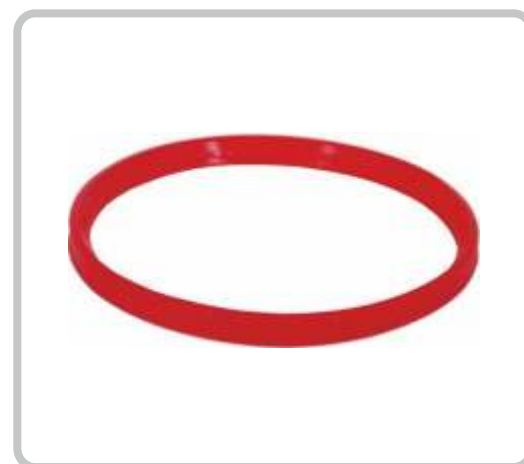

## FASCETTA DI BLOCCAGGIO

CODICE	DESCRIZIONE	CF	M.V.	PREZZO
20184 0080	80	20	1	€ 3,07
20184 0100	100	20	1	€ 3,28
20184 0120	120	20	1	€ 3,36
20184 0130	130	20	1	€ 3,47
20184 0140	140	20	1	€ 3,47
20184 0150	150	20	1	€ 3,68
20184 0160	160	10	1	€ 3,78
20184 0180	180	1	1	€ 3,89
20184 0200	200	1	1	€ 4,10
20184 0230	230	1	1	€ 5,25
20184 0250	250	1	1	€ 5,25
20184 0300	300	1	1	€ 5,25



## FASCETTA MURALE

CODICE	DESCRIZIONE	CF	M.V.	PREZZO
20186 0080	80	1	1	€ 15,75
20186 0100	100	1	1	€ 15,75
20186 0120	120	1	1	€ 17,85
20186 0130	130	1	1	€ 18,48
20186 0140	140	1	1	€ 19,74
20186 0150	150	1	1	€ 20,58
20186 0180	180	1	1	€ 25,20
20186 0200	200	1	1	€ 26,36
20186 0230	230	1	1	€ 27,83
20186 0250	250	1	1	€ 27,83
20186 0300	300	1	1	€ 33,60



## COLLARE FERMATUBO PER CANNA FUMARIA

CODICE	DESCRIZIONE	CF	M.V.	PREZZO
20188 0080	80	10	1	€ 6,93
20188 0100	100	10	1	€ 7,54
20188 0120	120	10	1	€ 7,93
20188 0130	130	10	1	€ 8,33
20188 0140	140	10	1	€ 8,93
20188 0150	150	10	1	€ 9,32
20188 0160	160	10	1	€ 9,92
20188 0180	180	10	1	€ 10,53
20188 0200	200	10	1	€ 10,92
20188 0250	250	10	1	€ 12,71
20188 0300	300	10	1	€ 15,49



# M8 - CANNE FUMARIE DOPPIA PARETE



## ELEMENTO DIRITTO Mt 1 DOPPIA PARETE

CODICE	DESCRIZIONE		CF	M.V.	PREZZO
	Ø int.	Ø est.			
20240 0813	80	130	1	1	€ 93,83
20240 1015	100	150	1	1	€ 112,54
20240 1318	130	180	1	1	€ 119,13
20240 1520	150	200	1	1	€ 132,00
20240 2025	200	250	1	1	€ 175,90
20240 2530	250	300	1	1	€ 187,21



## ELEMENTO DIRITTO Mt 0,5 DOPPIA PARETE

CODICE	DESCRIZIONE		CF	M.V.	PREZZO
	Ø int.	Ø est.			
20242 0813	80	130	1	1	€ 58,30
20242 1015	100	150	1	1	€ 62,70
20242 1318	130	180	1	1	€ 74,58
20242 1520	150	200	1	1	€ 82,28
20242 2025	200	250	1	1	€ 95,59
20242 2530	250	300	1	1	€ 110,00



## CURVA 45° DOPPIA PARETE

CODICE	DESCRIZIONE		CF	M.V.	PREZZO
	Ø int.	Ø est.			
20244 0813	80	130	1	1	€ 54,12
20244 1015	100	150	1	1	€ 59,18
20244 1318	130	180	1	1	€ 74,58
20244 1520	150	200	1	1	€ 79,42
20244 2025	200	250	1	1	€ 93,39
20244 2530	250	300	1	1	€ 109,23



## CURVA A 90° DOPPIA PARETE

CODICE	DESCRIZIONE		CF	M.V.	PREZZO
	Ø int.	Ø est.			
20246 0813	80	130	1	1	€ 101,20
20246 1015	100	150	1	1	€ 106,59
20246 1318	130	180	1	1	€ 139,04
20246 1520	150	200	1	1	€ 148,94
20246 2025	200	250	1	1	€ 169,95
20246 2530	250	300	1	1	€ 206,25

## RACCORDO A TEE 135° DOPPIA PARETE

CODICE	DESCRIZIONE		CF	M.V.	PREZZO
	Ø int.	Ø est.			
20248 0813	80	130	1	1	€ 141,33
20248 1015	100	150	1	1	€ 184,28
20248 1318	130	180	1	1	€ 227,33
20248 1520	150	200	1	1	€ 231,79
20248 2025	200	250	1	1	€ 312,48
20248 2530	250	300	1	1	€ 378,00



## RACCORDO A TEE 90° DOPPIA PARETE

CODICE	DESCRIZIONE		CF	M.V.	PREZZO
	Ø int.	Ø est.			
20250 0813	80	130	1	1	€ 115,50
20250 1015	100	150	1	1	€ 120,96
20250 1318	130	180	1	1	€ 157,50
20250 1520	150	200	1	1	€ 169,58
20250 2025	200	250	1	1	€ 192,68
20250 2530	250	300	1	1	€ 233,10



## RACCORDO A TEE 90° DOPPIA PARETE RIDOTTA A 80

CODICE	DESCRIZIONE			CF	M.V.	PREZZO
	Ø int.	Ø est.				
20252 0813	80	130	derivazione a 80	1	1	€ 98,83



## TAPPO CONDENSA DOPPIA PARETE

CODICE	DESCRIZIONE		CF	M.V.	PREZZO
	Ø int.	Ø est.			
20254 0813	80	130	1	1	€ 47,46
20254 1015	100	150	1	1	€ 48,04
20254 1318	130	180	1	1	€ 52,87
20254 1520	150	200	1	1	€ 57,23
20254 2025	200	250	1	1	€ 66,15
20254 2530	250	300	1	1	€ 74,03



# M8 - CANNE FUMARIE DOPPIA PARETE



## RACCORDO DA MONO A DOPPIA PARETE

CODICE	DESCRIZIONE		CF	M.V.	PREZZO
	Ø int.	Ø est.			
20260 0813	80	130	1	1	€ 48,83
20260 1015	100	150	1	1	€ 53,03
20260 1318	130	180	1	1	€ 60,90
20260 1520	150	200	1	1	€ 65,10



## RACCORDO DA DOPPIA PARETE A MONO PARETE

CODICE	DESCRIZIONE		CF	M.V.	PREZZO
	Ø int.	Ø est.			
20262 0813	80	130	1	1	€ 48,62
20262 1015	100	150	1	1	€ 53,03
20262 1318	130	180	1	1	€ 60,90
20262 1520	150	200	1	1	€ 65,10



## RACCORDO CALDAIA PER TUBO DOPPIA PARETE

CODICE	DESCRIZIONE		CF	M.V.	PREZZO
	Ø caldaia	Ø tubo			
20264 0813	80F	80F x 130M	1	1	€ 46,50
20264 1015	100F	100F x 150M	1	1	€ 50,50
20264 1318	130F	130F x 180M	1	1	€ 58,00
20264 1520	150F	150F x 200M	1	1	€ 62,50

## CAPPELLO EOLICO DOPPIA PARETE

CODICE	DESCRIZIONE		CF	M.V.	PREZZO
	Ø int.	Ø est.			
20270 0813	80	130	1	1	€ 128,37
20270 1015	100	150	1	1	€ 133,65
20270 1318	130	180	1	1	€ 140,25
20270 1520	150	200	1	1	€ 146,30
20270 2025	200	250	1	1	€ 183,15
20270 2530	250	300	1	1	€ 201,85



## CAPPELLO CINESE DOPPIA PARETE Ø ESTERNO FEMMINA

CODICE	DESCRIZIONE		CF	M.V.	PREZZO
	Ø int.	Ø est.			
20272 0813	80	130	1	1	€ 62,26
20272 1015	100	150	1	1	€ 67,65
20272 1318	130	180	1	1	€ 77,00
20272 1520	150	200	1	1	€ 79,75
20272 2025	200	250	1	1	€ 85,03
20272 2530	250	300	1	1	€ 102,30



## CAPPELLO ANTIRIFLUSSO DOPPIA PARETE Ø ESTERNO FEMMINA

CODICE	DESCRIZIONE		CF	M.V.	PREZZO
	Ø int.	Ø est.			
20274 0813	80	130	1	1	€ 84,70
20274 1015	100	150	1	1	€ 89,32
20274 1318	130	180	1	1	€ 101,97
20274 1520	150	200	1	1	€ 107,69
20274 2025	200	250	1	1	€ 121,00
20274 2530	250	300	1	1	€ 137,50



# CANNE FUMARIE

- Alluminio

- PPS

- Acciaio



# CANNE FUMARIE











RAGIONE SOCIALE \_\_\_\_\_

INDIRIZZO \_\_\_\_\_ CAP \_\_\_\_\_ CITTÀ \_\_\_\_\_ PROV. \_\_\_\_\_

INDIRIZZO DI CONSEGNA \_\_\_\_\_

CAP \_\_\_\_\_ CITTÀ \_\_\_\_\_ PROV. \_\_\_\_\_

TELEFONO \_\_\_\_\_ FAX \_\_\_\_\_ E-MAIL \_\_\_\_\_

PERSONA DA CONTATTARE \_\_\_\_\_

	CODICE	Q.TÀ	DESCRIZIONE	RIF. DDT
NOTE				

	CODICE	Q.TÀ	DESCRIZIONE	RIF. DDT
NOTE				

	CODICE	Q.TÀ	DESCRIZIONE	RIF. DDT
NOTE				

DATA

FIRMA AGENTE

TIMBRO E FIRMA ACCETTAZIONE

RAGIONE SOCIALE \_\_\_\_\_

INDIRIZZO \_\_\_\_\_ CAP \_\_\_\_\_ CITTÀ \_\_\_\_\_ PROV. \_\_\_\_\_

INDIRIZZO DI CONSEGNA \_\_\_\_\_

CAP \_\_\_\_\_ CITTÀ \_\_\_\_\_ PROV. \_\_\_\_\_

TELEFONO \_\_\_\_\_ FAX \_\_\_\_\_ E-MAIL \_\_\_\_\_

PERSONA DA CONTATTARE \_\_\_\_\_

	CODICE	Q.TÀ	DESCRIZIONE	RIF. DDT
NOTE				

	CODICE	Q.TÀ	DESCRIZIONE	RIF. DDT
NOTE				

	CODICE	Q.TÀ	DESCRIZIONE	RIF. DDT
NOTE				

DATA

FIRMA AGENTE

TIMBRO E FIRMA ACCETTAZIONE

**PUCCI**

**FARG**

**PEDROLLO**  
the spring of life

**APM**

**BAMPI**

**Roca**



**catjs**

**FACOT**  
CHEMICALS

**RINALDI & PETTINAROLI**

Rubinetterie Matella Giovanni  
evolution

**GIACOMINI**  
WATER EMOTION

**TECOM**

**istodini**

**innovita**

**Sunerg**  
SOLAR ENERGY

**CR**

**fischer**



**GABBAPLAST**

**PP**

**MGF**

**ISOCLIMA**

**WATRA**

**METAFORM**

**DAMAST**

**ENOLGAS**

**Laneri**  
sanitary ware

**Chaffoteaux**

**lazzarini**  
RADIATORI

**OLIMPIA  
SPLENDID**

**IDEMA**

**LOWARA**

**GEBERIT**



**CGS**

**CINQUE**  
VASI DI ESPANSIONE E FUOCO A MEMBRANA

**OLI**

**WT**  
WATERTECH



**IVR**  
Innovation Value Research

**GIAVA**

**atlantic**

**ICMA**  
Working Technology since 1974

**FAREN**  
CHEMICAL INNOVATION

**ATP**

**bonomini**  
TECNOLOGIE IDRAULICHE

**IRSAP**  
RADIADORES DECORATIVOS

**DAIKIN**

**XPOWER**  
WATER - PUMPS

**Gnali Bocia**  
Mondial GB

**BREMBOFLEX**  
**BF**

**JMC**  
ARREDO BAGNO

**G.GIOANOLA**

**SOUDAL**

**C.T.L.**

**ITALTHERM**

**FAR**  
flow evolution

**EcoPOL**  
S.R.L.

**ventilclima**  
FAN COIL UNITS

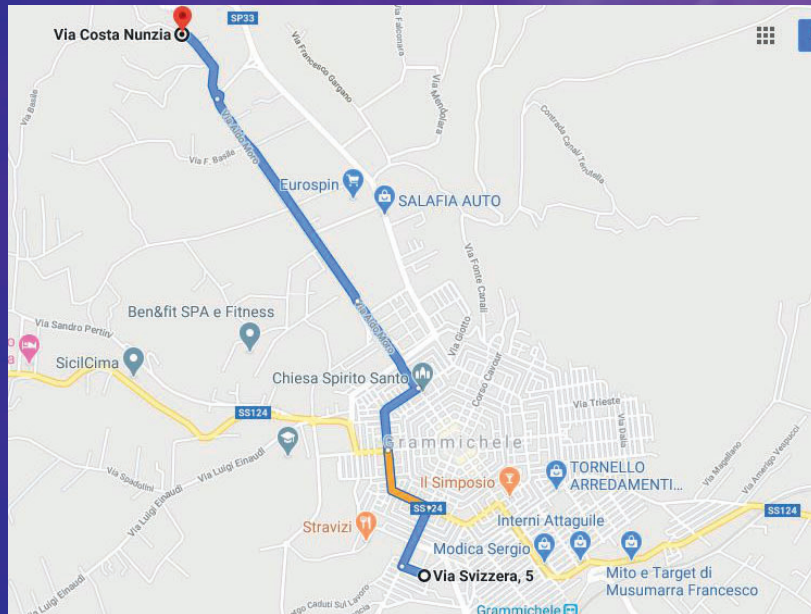

**TERMIDRAULICARUSSO.COM**